

THE FACTORY AUTOMATION COMPANY

**FANUC**

# CNC Functions • Communication • Software



**Power Motion *i*-A**

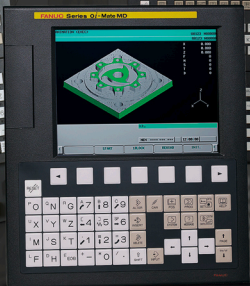

**CNC Series  
*0i*-MODEL F**



**CNC Series  
*30i/31i/32i*-MODEL B**

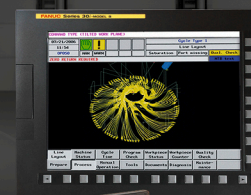

**CNC Series  
*35i*-MODEL B**



# 001

## Table of Contents

Foreword .....	018
CNC.....	019
Functions.....	020
Controlled Axis.....	021
Designation of Machine Control Type.....	022
Designation of Controlled Axes.....	023
Designation of Machine Groups.....	031
Designation of Control Paths.....	032
Controllable Axes Expansion.....	034
Simultaneously Controlled Axes Expansion.....	035
Axis Control by PMC.....	036
Designation of Spindle Axes.....	037
Cs Contouring Control.....	039
Loader Control Function.....	040
Addition of Loader Control Path.....	041
Peripheral Axis Control.....	042
Synchronous and Composite Control.....	043
Superimposed Control.....	044
Superimposed Control A.....	045
Superimposed Control for High-Speed Cycle Machining.....	046
Synchronous, Composite and Superimposed Control by Program Command.....	047
Flexible Path Axis Assignment.....	048
Axis Synchronous Control.....	049
Twin Table Control.....	050
Parallel Axis Control.....	051
Arbitrary Angular Axis Control.....	053
Inclined Rotary Axis Control.....	054
Pivot Axis Control.....	055
Tandem Disturbance Elimination Function.....	056
Pole Position Detection Function.....	057
Controlled Axes Detach.....	058
Dual Control Axes Switching.....	059
Chopping.....	060
Chopping Function by Flexible Synchronization Control.....	061

Chopping Setting Screen.....	062
High-Precision Oscillation Function.....	063
PMC Axis Control - Acceleration/Deceleration Specification Feed.....	064
Increment System C.....	065
Increment System D.....	066
Increment System E.....	067
Arbitrary Command Multiply.....	068
High-Precision Learning Control A.....	069
High-Precision Learning Control B.....	070
High-Precision Learning Control C.....	071
Learning Control for Parts Cutting A.....	072
Learning Control for Parts Cutting B.....	073
Spindle Learning Control.....	074
Spindle Learning Control in High-Precision Learning Control A/B.....	075
Learning Control - Memory Expansion.....	076
Learning Memory Size 10Mbyte.....	077
Dual Position Feedback.....	078
Position Feedback Dynamic Switching Function.....	079
HRV3 Control.....	080
HRV4 Control.....	081
Inch/Metric Conversion.....	082
Stored Stroke Check 1 Area Expansion.....	083
Stroke Limit External Setting.....	084
Stored Stroke Check 2,3.....	085
Stored Stroke Check Before Move.....	086
Stroke Limit Area Changing Function.....	087
Stored Stroke Limit Range Switching Function by Signal.....	088
Chuck and Tail Stock Barrier.....	089
Interference Check for Each Path.....	090
Interference Check for Rotary Area.....	091
Built-In 3D Interference Check.....	092
3D Interference Check with PC Function.....	094
Unexpected Disturbance Torque Detection Function.....	095
Unexpected Disturbance Torque Detection for BETA i I/O Link.....	096
Fine Torque Sensing.....	097

Rotary Axis Control.....	098
Position Switch.....	099
High-Speed Position Switch.....	100
Direction-Dependent Type of High-Speed Position Switch.....	101
Linear Scale Interface with Absolute Address Reference Mark.....	102
Temporary Absolute Coordinate Setting.....	104
Axis Immediate Stop Function.....	105
Cross Rail Axis Control.....	107
Multi-Axes Synchronous Function (Power Motion i-A).....	108
Multi-Axes High-Response Function.....	109
Skip Function for Multi-Axes High-Response Function.....	110
Position Definition Type Synchronous Function.....	111
Pressure and Position Control Function.....	112
Control Function for Link Type Press.....	113
Servo-On Synchronize Function.....	114
Position Control Keep Function.....	115
Electronic Cam Function.....	116
Operation.....	117
Sequence Number Comparison and Stop.....	118
Program Restart.....	119
Auxiliary Function Output During Program Restart.....	120
Quick Program Restart.....	121
Tool Retract and Recover.....	122
Manual Intervention and Return.....	123
Retraction for Rigid Tapping.....	124
Retraction for 3-Dimensional Rigid Tapping.....	125
Manual 2nd/3rd/4th Reference Position Return.....	126
Reference Point Setting with Mechanical Stopper.....	127
Reference Point Setting with Mechanical Stopper for Feed Axis Synchronization Control.....	128
Reference Point Setting with Mechanical Stopper by Grid Method.....	129
Manual Handle Feed 1 Unit.....	130
Manual Handle Feed 2/3 Units.....	131
Manual Handle Feed 4/5 Units.....	132
Manual Handle Feed - Multiple 10 Million.....	133
3-Dimensional Manual Feed.....	134

Handle Interruption.....	135
Manual Interruption of 3D Coordinate Conversion.....	136
Manual Handle Interface for BETA i Series with I/O-Link.....	137
Manual Numerical Command.....	138
Reference Position Signal Output.....	139
Retrace.....	140
Manual Handle Retrace.....	141
Manual Handle Retrace for Multi-Path.....	142
Direction Change Movement in Auxiliary Function Output Block Function.....	143
Manual Linear/Circular Interpolation.....	144
Reverse Motion Function for Restart.....	145
Active Block Cancel.....	146
High-Speed Program Check.....	147
Time Override Function for Dwell/Auxiliary Function.....	148
Pulse Superimposed Function.....	149
MDI Reset Key Invalidation.....	150
Interpolation Functions.....	151
Single Direction Positioning.....	152
Exponential Interpolation.....	153
Polar Coordinate Interpolation.....	154
Cylindrical Interpolation.....	155
Cylindrical Interpolation by Plane Distance Command.....	156
Helical Interpolation.....	157
Helical Interpolation B.....	158
Learning Helical Interpolation.....	159
Involute Interpolation.....	160
Hypothetical Axes Interpolation.....	161
Conical/Spiral Interpolation.....	162
Smooth Interpolation.....	163
Nano Smoothing.....	164
Smooth Tolerance Control.....	165
Thread Cutting, Synchronous Cutting.....	166
Thread Cutting Retract.....	167
Variable Lead Thread Cutting.....	168
Circular Thread Cutting.....	169

# 005

Circular Thread Cutting B.....	170
Polygon Turning.....	171
Polygon Machining with Two Spindles.....	172
Multi-Step Skip Function.....	173
High-Speed Skip Function.....	174
3rd/4th Reference Position Return.....	175
Floating Reference Position Return.....	176
Normal Direction Control.....	177
NURBS Interpolation.....	178
3-Dimensional Circular Interpolation.....	179
Balanced Cutting.....	180
Index Table Indexing.....	181
Continuous High-Speed Skip.....	182
Gentle Normal Direction Control.....	183
Continuous Dressing.....	184
Infeed Control.....	185
High-Speed Cycle Cutting.....	186
High-Speed Cycle Machining Retract Function.....	187
High-Speed Cycle Machining Skip Function.....	188
High-Speed Cycle Cutting Additional Variables A.....	189
High-Speed Cycle Cutting Additional Variables B.....	190
High-Speed Cycle Cutting Additional Variables C.....	191
High-Speed Cycle Cutting Additional Variables D.....	192
High-Speed Cycle Cutting Additional Variables E.....	193
High-Speed Cycle Machining Operation Information Output Function.....	194
General Purpose Retract.....	195
Path Table Operation (PTO).....	196
Spindle Speed Fluctuation Detection for Path Table Operation.....	197
Polygon Turning Function for Path Table Operation.....	198
Threading Start Position Shift Function for Path Table Operation.....	199
Tool Offset Function for Path Table Operation.....	200
Cycle Table Operation Function for Path Table Operation.....	201
Delay Time Setting Function of Auxiliary Function Output for PTO.....	202
Path Table Direct Conversion Function.....	203
High-Speed Signal Output Function for Path Table Operation.....	204

Incremental Command for Path Table Operation.....	205
Sub-Table Call for Path Table Operation.....	206
Cutting / Rapid Switching Function for Path Table Operation.....	207
Path Table Operation Execution Data Size 20Mbyte.....	209
Path Table Operation History Function.....	210
High-Speed Binary Program Operation.....	211
High-Speed Binary Program Operation on 2-Path Control.....	212
High-Speed Binary Program Operation Retract Function.....	213
Hypothetical Linear Axis Interpolation.....	214
High-Speed and High-Quality Machining Package.....	215
Feed Functions.....	216
Optimum Torque Acceleration/Deceleration.....	217
Positioning by Optimum Acceleration.....	218
Bell-Shaped Acc./Dec. After Cutting Feed Interpolation.....	219
2nd Feedrate Override.....	220
One-Digit F-Code Feed.....	221
Inverse Time Feed.....	222
Rate Feed.....	223
External Deceleration.....	225
Feed Stop.....	226
Feedrate Control with Acceleration in Circular Interpolation.....	227
Advanced Preview Control.....	228
AI Contour Control I.....	229
AI Contour Control II.....	230
Look-Ahead Blocks Expansion of AI Contour Control II.....	231
High-Speed Processing.....	232
Look-Ahead Blocks Expansion.....	233
Jerk Control.....	234
Rigid Tapping with Bell-Shaped Acceleration/Deceleration.....	235
Optimum Torque Acceleration/Deceleration for Rigid Tapping.....	236
Programmable Rapid Traverse Overlap.....	237
Feedrate Change Function.....	238
Time Constant of Acc./Dec. After Interpolation Switching Function by Signal.....	239
High-Speed Feedrate Override.....	240
Maximum Look-Ahead Blocks 400.....	241

Smart Adaptive Control.....	242
Program Input.....	243
Optional Block Skip.....	244
Dynamic Switching of Diameter/Radius Specification.....	245
Plane Conversion Function.....	246
Polar Coordinate Command.....	247
Workpiece Coordinate System.....	248
Workpiece Coordinate System Preset.....	249
Addition of Workpiece Coordinate System 48 Pairs.....	250
Addition of Workpiece Coordinate System 300 Pairs.....	251
Positioning in Machine Coordinate System with Feedrate.....	252
Direct Drawing Dimension Programming.....	253
G-Code System B/C.....	254
Lathe / Machining Center G-Code System Switching Function.....	256
Chamfering / Corner Rounding.....	257
Optional Chamfering / Corner Rounding.....	258
Custom Macro.....	259
Addition of Custom Macro Common Variables.....	261
Addition of Custom Macro Common Variables 1000.....	262
Interruption Type Custom Macro.....	263
Multi-Repetitive Cycles.....	264
Multi-Repetitive Cycles II.....	265
Canned Cycles for Drilling.....	266
In-Position Check Switching Function for Drilling Canned Cycle.....	267
Mirror Image for Double Turret.....	268
Automatic Corner Override.....	269
Scaling.....	270
Coordinate System Rotation.....	271
3-Dimensional Coordinate System Conversion.....	272
Tilted Working Plane (TWP).....	273
Programmable Mirror Image.....	275
Figure Copying.....	276
Tape Format for Series 15 CNC.....	277
Macro Executor.....	278
Extended Conversational Macro Function.....	280



Macro Executor + C-Language Executor.....	281
C Language Executor Additional SRAM.....	283
Middle-Level Task for C-Language Executor.....	284
Custom Software Size.....	285
FANUC PICTURE Executor.....	287
FANUC PICTURE Function.....	288
FANUC PICTURE Function for Series 35i.....	290
FANUC PICTURE Function for Power Motion i.....	291
Embedded Macro.....	292
Small-Hole Peck Drilling Cycle.....	293
Canned Cycles for Grinding.....	294
Real Time Custom Macro.....	295
Pattern Data Input.....	296
M-Code Protect Function.....	297
Groove Cutting Function by Continuous Circle Movement.....	298
Macro for Multi-Axes High-Response Function.....	299
Extended P-Code Variables Size.....	300
Number of Custom Macro Variable Name 1000.....	301
Number of Custom Macro Variable Name 4000.....	302
Set-Up Guidance Function.....	303
Integrated Operation & Programming Guidance Functions.....	304
MANUAL GUIDE i Basic Software.....	305
MANUAL GUIDE i Multi-Path Support.....	307
MANUAL GUIDE i Tilted Working Plane (TWP) Machining Function.....	308
MANUAL GUIDE i Windows Call Function.....	310
MANUAL GUIDE i Handle Machining Function.....	311
MANUAL GUIDE i Advanced Guidance Function.....	312
MANUAL GUIDE i Extended Axis Name Function.....	313
MANUAL GUIDE 0i.....	314
TURN MATE i Basic Software.....	316
TURN MATE i MDI Key Operation Function.....	318
TURN MATE i NC Program Conversion Function.....	319
TURN MATE i Expansion of Machining Cycles.....	320
iHMI Machining Cycle.....	321
iHMI Set-Up Guidance.....	322

iHMI Conversational Programming for Complex Lathe.....	323
Auxiliary / Spindle Speed Functions.....	324
2nd Auxilliary Function.....	325
Auxiliary Function Output in Moving Axis.....	326
Waiting Function by Specifying Start Point.....	327
Spindle Serial Output.....	328
Spindle Analog Output.....	329
Constant Surface Speed Control.....	330
Actual Spindle Speed Output.....	331
Spindle Orientation.....	332
Spindle Output Switching Function.....	333
Spindle Synchronous Control.....	334
Simple Spindle Synchronous Control.....	335
Multi-Spindle Control.....	336
Spindle Positioning.....	337
Rigid Tapping.....	338
Rigid Tapping by Manual Handle.....	339
Arbitrary Position Reference Setting for Cs Axis.....	340
M-Code Group Check Function.....	341
Spindle Speed Fluctuation Detection.....	342
Spindle Control with Servo Motor.....	343
Spindle Control with Cs Contour Control.....	345
Spindle Control Switching Function for High-Speed Machining.....	346
Thread Start Position Compensation for Changing Spindle Speed.....	347
Arbitrary Speed Threading.....	348
Designation of Servo Axes for Spindle Use.....	349
Extended Spindle Orientation.....	350
Extended Spindle Output Switching Function.....	351
Spindle Axes Expansion.....	352
Spindle Serial/Analog Output.....	353
Spindle Switching Function.....	354
Spindle Synchronous Control for Guide Bush.....	355
Tool Functions / Tool Compensation.....	356
Tool Offset Pairs.....	357
Tool Offset Memory B.....	359

Tool Offset Memory C.....	360
Tool Offset.....	361
Tool Center Point Control.....	362
Tool Posture Control.....	363
Cutting Point Command.....	364
Smooth TCP.....	365
High-Speed Smooth TCP.....	366
Expansion of Axis Command in Tool Center Point Control.....	367
Y-Axis Offset.....	368
4th/5th Axis Offset.....	369
Tool Radius / Tool Nose Radius Compensation.....	370
Automatic Tool Nose Radius Compensation.....	371
3-Dimensional Tool Compensation.....	372
Cutting Point Interpolation for Cylindrical Interpolation.....	373
Tool Geometry/Wear Compensation.....	374
2nd Geometry Tool Offset.....	375
Tool Pairs for Tool Management Function.....	376
Customized Data Expansion.....	378
Tool Management Expansion.....	379
Tool Management Function for Multi-Edge Tools.....	380
Tool Attachment/Detachment Management Function.....	381
Tool Management Expansion B.....	382
Automatic Tool Length Measurement.....	383
High-Speed Measuring Position Reach Signal Input.....	384
Tool Length / Work Zero Point Measurement.....	385
Direct Input of Offset Value Measured B.....	386
Rotary Table Dynamic Fixture Offset.....	387
Wheel Wear Compensation.....	388
Changing Active Offset Value with Manual Move.....	389
Tool Length Compensation in Tool Axis Direction.....	390
3-Dimensional Cutter Compensation.....	391
Workpiece Setting Error Compensation.....	392
Direct Input of Offset Value Measured B for 2-Spindle Lathe.....	393
Tool Life Management.....	394
Spindle Unit Compensation.....	395

Nutating Rotary Head Tool Length Compensation.....	396
Automatic Alteration of Tool Position Compensation.....	397
Tool Offset for Milling and Turning Function.....	398
Tool Offset Conversion Function.....	399
Tool Geometry Size Data.....	400
Tool Geometry Size Data - Additional Tool Type.....	401
Accuracy Compensation Functions.....	402
Stored Pitch Error Compensation.....	403
Interpolation Type Pitch Error Compensation.....	404
Bi-Directional Pitch Error Compensation.....	405
Extended Bi-Directional Pitch Error Compensation.....	406
Periodical Secondary Pitch Error Compensation.....	407
Inclination Compensation.....	409
Straightness Compensation.....	410
Interpolation Type Straightness Compensation.....	411
Interpolated Straightness Compensation 3072 Points.....	412
3-Dimensional Error Compensation.....	413
Thermal Growth Compensation Along Tool Vector.....	414
Linear Inclination Compensation Function.....	415
3-Dimensional Machine Position Compensation.....	416
3-Dimensional Rotary Error Compensation.....	417
Hobbing / Electronic Gear Box.....	418
Electronic Gear Box (EGB).....	419
Skip Function for Electronic Gear Box (EGB) Axis.....	420
Electronic Gear Box (EGB) - 2 pairs.....	421
Electronic Gear Box (EGB) Automatic Phase Synchronization.....	422
Spindle Electronic Gear Box (EGB).....	423
Flexible Synchronization Control.....	424
Automatic Phase Synchronization for Flexible Synchronization Control.....	425
Inter-Path Flexible Synchronization Control.....	426
Skip Function for Flexible Synchronization Control.....	427
Hob Command by Flexible Synchronization Control.....	428
U-Axis Control 2 pairs.....	429
Grinding Functions.....	430
Punch Press Functions.....	431

C-Axis Control.....	432
T- and C-Axes Simultaneous Control.....	434
Safety Zone Check.....	435
Safety Zone Area Expansion.....	436
Clamp Zone Avoidance Function.....	437
RAM-Axis Control.....	438
Program Auto Restart.....	439
Linear/Circular Punch Command.....	440
Y-Axis Crack Cancel.....	441
Multi-Piece Machining.....	442
Multi-Piece Machining End Area Command.....	443
Tool Data Setting Function.....	444
Multiple Tool Control.....	445
Tool Life Management.....	446
High Speed Press Function.....	447
Laser Functions.....	448
Standard Laser Functions.....	449
Cutting Condition Setting Function.....	450
Addition of Cutting Condition Data.....	451
Edge Machine Function.....	452
Minimum Unit 1% Duty Override.....	453
Laser High-Speed Control Function 2.....	454
Laser Oscillator Communication Control (FSSB Connection).....	455
Gap Control for Laser.....	456
Automatic Gap Control Axis Retract & Approaching Function.....	457
Program Auto Restart.....	458
Cutting Restart.....	459
Multi-Piece Machining.....	460
Multi-Piece Machining End Area Command.....	461
Enhanced Buffer.....	462
Attitude Control.....	463
Interaction Control.....	464
W-Axis Gap Control.....	465
Bevel Cutting Compensation Function.....	466
Punch Press Function for Compound Cutting.....	467

Gas Cutting Machine Functions.....	468
Functions for Gas Cutting Machine.....	469
Automatic Exact Stop Check.....	470
Torch Swing for Gas Cutting Machine.....	471
In-Acceleration/Deceleration Signal.....	472
Gentle Curve Cutting.....	473
Corner Control by Feedrate.....	474
Tool Offset B.....	475
Gap Control.....	476
Editing Operation.....	477
Part Program Storage Size.....	478
Number of Registered Programs.....	480
Key and Program Encryption.....	481
Playback.....	482
Machining Time Stamp.....	483
Background Editing.....	484
Memory Card Program Entry Count Extension.....	485
Template Program Function.....	486
Multi-Path Editing Function.....	488
High-Speed Program Management.....	489
Multi-Path Program Management Function.....	490
Cycle Time Estimate for iHMI.....	491
Cycle Time Estimate Library Function.....	492
Setting and Display.....	493
Run Hour and Parts Count Display.....	494
Machine Alarm Diagnosis.....	495
Servo/Spindle Waveform Data Output Function.....	497
Software Operator's Panel.....	498
Software Operator's Panel General Purpose Switch.....	499
Machine Operation Menu.....	500
FANUC Auto HMI-NC.....	502
Multi-Language Display.....	504
Selection of Five Optional Languages.....	509
Protection of Data at Eight Levels.....	510
Machining Condition Selecting Function.....	511

Machining Quality Level Adjustment.....	512
Graphic Function.....	513
Dynamic Graphic Display Function.....	514
Touch Panel Control.....	515
External Touch Panel Interface.....	516
Two Touch Panels Control for Stand-Alone Type CNC.....	517
Virtual MDI Key.....	518
Ethernet Display Function.....	519
Ethernet Display Sharing Function.....	520
Twin Display Function with Ethernet.....	521
CNC Screen Dual Display Function.....	522
CNC Screen Display for 19" LCD.....	523
Enlarged CNC Screen Display for 19" LCD.....	524
CNC Screen Web Server Function.....	525
Energy Saving Level Selection Function.....	526
Machine State Monitoring Function.....	527
Machine Configuration Selecting Function.....	528
5-Axis Machining Condition Setting Function.....	529
Main Menu Screen.....	530
Warning Function Against Modification of Setting.....	532
Machine Setting Switching Function.....	533
Data Input/Output.....	534
RS232C Interface.....	535
RS232C Interface Expansion of Receiving Buffer.....	536
Fast Data Server.....	537
Data Server Explorer Connection.....	538
External Tool Offset.....	539
External Machine Zero Point Shift.....	540
External Message.....	541
External Data Input.....	542
Power Mate CNC Manager.....	543
External I/O Device Control.....	544
One Touch Macro Call.....	545
Automatic Data Backup.....	546
PMC System.....	548

PMC Ladder Function.....	549
Multi-Path PMC Function.....	551
PMC Symbol, Comment and Message Area Expansion.....	552
Step Sequence Function.....	554
Non-Volatile PMC Extra Relay Function.....	556
Non-Volatile PMC Data Table Area Expansion (40kB).....	557
PMC Function Block Function.....	558
Machine Safety Functions.....	559
Dual Check Safety (DCS).....	560
Safety I/O Signal History Function.....	562
Safety Spindle Speed Limit Override.....	563
Test Mode Function for Dual Check Safety Acceptance Test.....	564
Option Packages.....	565
Basic Option.....	566
Milling Standard Package.....	568
Communication.....	570
Embedded Ethernet.....	571
Fast Ethernet.....	573
PROFIBUS-DP Master.....	575
PROFIBUS-DP Slave.....	577
DeviceNet Scanner (Master).....	579
DeviceNet Adapter (Slave).....	581
High Speed Serial Bus (HSSB).....	582
FL-net.....	584
FL-net Safety.....	586
CC-Link Remote Device.....	588
Robot Connection Function.....	590
EtherNet/IP Scanner.....	592
EtherNet/IP Adapter.....	594
EtherNet/IP Adapter Safety Function.....	596
Modbus/TCP Server.....	597
PROFINET I/O Controller.....	599
PROFINET I/O Device.....	601
PROFINET I/O Device Safety Function.....	603
Inter-Unit Synchronization (Power Motion i-A).....	604



Software.....	605
CNC Application Development Kit.....	606
Acceptance Test Assist Tool.....	607
Basic Operation Package 2.....	608
C-Language Library for C-Language Executor.....	609
CNC Screen Display Function (SDF).....	610
Electronic Cam Support Tool.....	611
FANUC PICTURE.....	612
FOCAS2 Library.....	613
Guidance Table for Machine Alarm Diagnosis.....	614
LADDER Editing Package Execute Files.....	615
Machine Operation Menu Making Tool.....	616
Machining Status Monitor Package Disk.....	617
MACRO Compiler and Library.....	618
Main Menu Screen Customization Tool.....	620
Operation History Converter Tool.....	621
NCGuide.....	622
Cycle Time Estimate Function for NCGuide.....	623
NCGuide Academic Package.....	625
FANUC Auto HMI-NC disk.....	626
FANUC Ladder-III.....	627
FANUC SERVO GUIDE.....	629
3D Error Compensation Setting Tool.....	631
Built-In 3D Interference Check Setting Tool.....	632
CNC Setting Tool.....	633
CNC Parameter Setting Tool.....	634
FL-net Setting Tool.....	635
PROFIBUS Setting Tool.....	636
FANUC Connect.....	637
FANUC Customize Assist.....	638
Machine Remote Diagnosis Package.....	639
MT-LINKi - CNC Data Collection Software for PC.....	641
OPC Server.....	642
Parameter Conversion Support Tool.....	643
PC Tool for Memory Card Program Operation/Editing.....	644

Program Transfer Tool.....	645
SERVO Viewer.....	646
iHMI Application SDK for Panel iH.....	647
Disk for Cycle Time Estimate Function.....	648
Machine Collision Avoidance for Panel iH Pro.....	649

Datasheets.....	
-----------------	--

## Foreword

---

You will find in this catalog an extensive selection of essential product information about FANUC components, functions and software. There are many FANUC products available to help you build the most competitive machine or automated system. This catalog contains a lot of information but cannot cover all subjects extensively; use it as a guide and do not hesitate to call your local FANUC representative for further information and assistance.

### About controller functions

The descriptions of each function provided in this catalogue may contain information, descriptions, technical data as well as performance data which may not always apply as described. Certain functions may require additional hardware, different CPU type or additional memory capacity or may cause compatibility issue with other functions. The functions described are options and may not be installed on a given configuration. It is however mostly possible to purchase additional functions and hardware to retrofit an existing system to increase its productivity. In case of doubt or if you need additional information on functions, compatibility and retrofit, contact your FANUC representative.

### Export control

The products listed in this catalogue may be subject to export control laws and regulations of Japan, the United States of America, the European Union, its Member States and any amendments thereof. Contact your FANUC representative for further information.

### Notes

The illustrations, charts, sample programs and layout examples shown in this catalogue are intended solely for purposes of example. Availability and technical specifications are subject to change without notice.

### Copyrights

Trademarks referenced herein are either owned by FANUC or are used solely for purposes of identifying compatibility with the products of FANUC and are owned by their respective companies. Copyright © 2017 FANUC Europe Corporation, 7 rue Benedikt Zender, L-6468 Echternach, Grand-Duché de Luxembourg. All rights reserved.

#### Notice

Certain functions may require additional hardware, different CPU type or additional memory capacity or may cause compatibility issue with other functions. In case of doubt, contact your FANUC sales representative for additional information and support.

The information given in the FANUC manuals or original manufacturer documentation shall prevail. Technical data is subject to change without prior notice. No part of this document may be reproduced in any form. All rights reserved. © FANUC 2017

# 019

## CNC

---

FANUC develops and manufactures state-of-the-art automation products and solutions. The CNC product range includes both entry-level and complex CNC products with high-speed functions, digitally controlled servo motors and spindle motors, and user-friendly operator interfaces.

The FANUC CNC system is installed in the machine in the form of a productive CNC package complete with CNC, amplifier, motors, I/O modules and operator panel. Such a complete CNC concept promises that the components are coordinated to optimum effect, offering the highest performance and productivity.



### Notice

Certain functions may require additional hardware, different CPU type or additional memory capacity or may cause compatibility issue with other functions. In case of doubt, contact your FANUC sales representative for additional information and support.

The information given in the FANUC manuals or original manufacturer documentation shall prevail. Technical data is subject to change without prior notice. No part of this document may be reproduced in any form. All rights reserved. © FANUC 2017

# 020

## CNC

## Functions

---

This section of the catalogue describes functions provided by the CNC software. They have been grouped by relevance to provide a better overview.

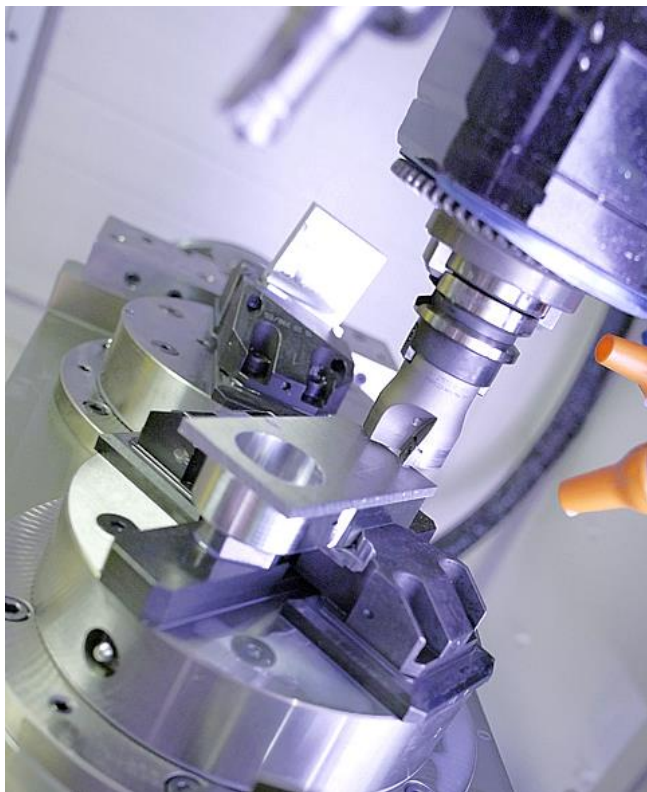

### Notice

Certain functions may require additional hardware, different CPU type or additional memory capacity or may cause compatibility issue with other functions. In case of doubt, contact your FANUC sales representative for additional information and support.

The information given in the FANUC manuals or original manufacturer documentation shall prevail. Technical data is subject to change without prior notice. No part of this document may be reproduced in any form. All rights reserved. © FANUC 2017

# 021

## Functions

## Controlled Axis

---

This section of the catalogue contains the functions related to axis control in the CNC, from the number of axes, paths and axes groups, via many other synchronization and precision and safety functions.

Some of the functions detailed in the catalogue:

- Designation of controlled axes, machine groups, path and technology
- Cs contouring control
- Synchronous / Composite control
- Tandem control
- Chopping
- High precision learning control
- HRV Control
- Interference check functions
- Built-in 3D interference check
- Unexpected disturbance torque detection function
- Dual Check Safety (DCS)
- Etc.

### Notice

Certain functions may require additional hardware, different CPU type or additional memory capacity or may cause compatibility issue with other functions. In case of doubt, contact your FANUC sales representative for additional information and support.

The information given in the FANUC manuals or original manufacturer documentation shall prevail. Technical data is subject to change without prior notice. No part of this document may be reproduced in any form. All rights reserved. © FANUC 2017

# 022

## Controlled Axis

# Designation of Machine Control Type

This function defines the machine type as controlled by the CNC. It can be chosen between Machining Center, Lathe or Multiple System, i.e. combination of Lathe and Machining Center functions.

## Ordering Information

Specification	Description
A02B-0323-S838#C	30i-B Designation of Machine Control Type, Multiple System - Selection of either Machining Center and Lathe for each Path
A02B-0323-S838#M	30i-B Designation of Machine Control Type, Machining Center
A02B-0323-S838#T	30i-B Designation of Machine Control Type, Lathe
A02B-0326-S838#C	31i-B5 Designation of Machine Control Type, Multiple System - Selection of either Machining Center and Lathe for each Path
A02B-0326-S838#M	31i-B5 Designation of Machine Control Type, Machining Center
A02B-0326-S838#T	31i-B5 Designation of Machine Control Type, Lathe
A02B-0327-S838#C	31i-B Designation of Machine Control Type, Multiple System - Selection of either Machining Center and Lathe for each Path
A02B-0327-S838#M	31i-B Designation of Machine Control Type, Machining Center
A02B-0327-S838#T	31i-B Designation of Machine Control Type, Lathe
A02B-0328-S838#C	32i-B Designation of Machine Control Type, Multiple System - Selection of either Machining Center and Lathe for each Path
A02B-0328-S838#M	32i-B Designation of Machine Control Type, Machining Center
A02B-0328-S838#T	32i-B Designation of Machine Control Type, Lathe

### Notice

Certain functions may require additional hardware, different CPU type or additional memory capacity or may cause compatibility issue with other functions. In case of doubt, contact your FANUC sales representative for additional information and support.

The information given in the FANUC manuals or original manufacturer documentation shall prevail. Technical data is subject to change without prior notice. No part of this document may be reproduced in any form. All rights reserved. © FANUC 2017

# 023

## Controlled Axis

# Designation of Controlled Axes

This function specifies the maximum number of axes that the CNC can control. The number of maximum controlled axes is the sum of the number of machine controlled axes and the number of loader controlled axes.

The number of Cs and PMC axes is included in the number of machine controlled axes.

The maximum number of axes is also linked to the hardware configuration of the CNC.

## Ordering Information

Specification	Description
A02B-0323-J802#1	30i-B Designation of Number of Axes, 1 Axis
A02B-0323-J802#10	30i-B Designation of Number of Axes, 10 Axes
A02B-0323-J802#11	30i-B Designation of Number of Axes, 11 Axes
A02B-0323-J802#12	30i-B Designation of Number of Axes, 12 Axes
A02B-0323-J802#13	30i-B Designation of Number of Axes, 13 Axes
A02B-0323-J802#14	30i-B Designation of Number of Axes, 14 Axes
A02B-0323-J802#15	30i-B Designation of Number of Axes, 15 Axes
A02B-0323-J802#16	30i-B Designation of Number of Axes, 16 Axes
A02B-0323-J802#17	30i-B Designation of Number of Axes, 17 Axes
A02B-0323-J802#18	30i-B Designation of Number of Axes, 18 Axes
A02B-0323-J802#19	30i-B Designation of Number of Axes, 19 Axes
A02B-0323-J802#2	30i-B Designation of Number of Axes, 2 Axes
A02B-0323-J802#20	30i-B Designation of Number of Axes, 20 Axes
A02B-0323-J802#21	30i-B Designation of Number of Axes, 21 Axes
A02B-0323-J802#22	30i-B Designation of Number of Axes, 22 Axes
A02B-0323-J802#23	30i-B Designation of Number of Axes, 23 Axes
A02B-0323-J802#24	30i-B Designation of Number of Axes, 24 Axes
A02B-0323-J802#25	30i-B Designation of Number of Axes, 25 Axes
A02B-0323-J802#26	30i-B Designation of Number of Axes, 26 Axes
A02B-0323-J802#27	30i-B Designation of Number of Axes, 27 Axes
A02B-0323-J802#28	30i-B Designation of Number of Axes, 28 Axes
A02B-0323-J802#29	30i-B Designation of Number of Axes, 29 Axes
A02B-0323-J802#3	30i-B Designation of Number of Axes, 3 Axes
A02B-0323-J802#30	30i-B Designation of Number of Axes, 30 Axes
A02B-0323-J802#31	30i-B Designation of Number of Axes, 31 Axes
A02B-0323-J802#32	30i-B Designation of Number of Axes, 32 Axes
A02B-0323-J802#33	30i-B Designation of Number of Axes, 33 Axes
A02B-0323-J802#34	30i-B Designation of Number of Axes, 34 Axes

### Notice

Certain functions may require additional hardware, different CPU type or additional memory capacity or may cause compatibility issue with other functions. In case of doubt, contact your FANUC sales representative for additional information and support.

The information given in the FANUC manuals or original manufacturer documentation shall prevail. Technical data is subject to change without prior notice. No part of this document may be reproduced in any form. All rights reserved. © FANUC 2017



Specification	Description
A02B-0323-J802#35	30i-B Designation of Number of Axes, 35 Axes
A02B-0323-J802#36	30i-B Designation of Number of Axes, 36 Axes
A02B-0323-J802#37	30i-B Designation of Number of Axes, 37 Axes
A02B-0323-J802#38	30i-B Designation of Number of Axes, 38 Axes
A02B-0323-J802#39	30i-B Designation of Number of Axes, 39 Axes
A02B-0323-J802#4	30i-B Designation of Number of Axes, 4 Axes
A02B-0323-J802#40	30i-B Designation of Number of Axes, 40 Axes
A02B-0323-J802#41	30i-B Designation of Number of Axes, 41 Axes
A02B-0323-J802#42	30i-B Designation of Number of Axes, 42 Axes
A02B-0323-J802#43	30i-B Designation of Number of Axes, 43 Axes
A02B-0323-J802#44	30i-B Designation of Number of Axes, 44 Axes
A02B-0323-J802#45	30i-B Designation of Number of Axes, 45 Axes
A02B-0323-J802#46	30i-B Designation of Number of Axes, 46 Axes
A02B-0323-J802#47	30i-B Designation of Number of Axes, 47 Axes
A02B-0323-J802#48	30i-B Designation of Number of Axes, 48 Axes
A02B-0323-J802#49	30i-B Designation of Number of Axes, 49 Axes
A02B-0323-J802#5	30i-B Designation of Number of Axes, 5 Axes
A02B-0323-J802#50	30i-B Designation of Number of Axes, 50 Axes
A02B-0323-J802#51	30i-B Designation of Number of Axes, 51 Axes
A02B-0323-J802#52	30i-B Designation of Number of Axes, 52 Axes
A02B-0323-J802#53	30i-B Designation of Number of Axes, 53 Axes
A02B-0323-J802#54	30i-B Designation of Number of Axes, 54 Axes
A02B-0323-J802#55	30i-B Designation of Number of Axes, 55 Axes
A02B-0323-J802#56	30i-B Designation of Number of Axes, 56 Axes
A02B-0323-J802#57	30i-B Designation of Number of Axes, 57 Axes
A02B-0323-J802#58	30i-B Designation of Number of Axes, 58 Axes
A02B-0323-J802#59	30i-B Designation of Number of Axes, 59 Axes
A02B-0323-J802#6	30i-B Designation of Number of Axes, 6 Axes
A02B-0323-J802#60	30i-B Designation of Number of Axes, 60 Axes
A02B-0323-J802#61	30i-B Designation of Number of Axes, 61 Axes
A02B-0323-J802#62	30i-B Designation of Number of Axes, 62 Axes
A02B-0323-J802#63	30i-B Designation of Number of Axes, 63 Axes
A02B-0323-J802#64	30i-B Designation of Number of Axes, 64 Axes
A02B-0323-J802#65	30i-B Designation of Number of Axes, 65 Axes
A02B-0323-J802#66	30i-B Designation of Number of Axes, 66 Axes
A02B-0323-J802#67	30i-B Designation of Number of Axes, 67 Axes
A02B-0323-J802#68	30i-B Designation of Number of Axes, 68 Axes
A02B-0323-J802#69	30i-B Designation of Number of Axes, 69 Axes
A02B-0323-J802#7	30i-B Designation of Number of Axes, 7 Axes
A02B-0323-J802#70	30i-B Designation of Number of Axes, 70 Axes

**Notice**

Certain functions may require additional hardware, different CPU type or additional memory capacity or may cause compatibility issue with other functions. In case of doubt, contact your FANUC sales representative for additional information and support.

The information given in the FANUC manuals or original manufacturer documentation shall prevail. Technical data is subject to change without prior notice. No part of this document may be reproduced in any form. All rights reserved. © FANUC 2017

# 025

Specification	Description
A02B-0323-J802#71	30i-B Designation of Number of Axes, 71 Axes
A02B-0323-J802#72	30i-B Designation of Number of Axes, 72 Axes
A02B-0323-J802#73	30i-B Designation of Number of Axes, 73 Axes
A02B-0323-J802#74	30i-B Designation of Number of Axes, 74 Axes
A02B-0323-J802#75	30i-B Designation of Number of Axes, 75 Axes
A02B-0323-J802#76	30i-B Designation of Number of Axes, 76 Axes
A02B-0323-J802#77	30i-B Designation of Number of Axes, 77 Axes
A02B-0323-J802#78	30i-B Designation of Number of Axes, 78 Axes
A02B-0323-J802#79	30i-B Designation of Number of Axes, 79 Axes
A02B-0323-J802#8	30i-B Designation of Number of Axes, 8 Axes
A02B-0323-J802#80	30i-B Designation of Number of Axes, 80 Axes
A02B-0323-J802#81	30i-B Designation of Number of Axes, 81 Axes
A02B-0323-J802#82	30i-B Designation of Number of Axes, 82 Axes
A02B-0323-J802#83	30i-B Designation of Number of Axes, 83 Axes
A02B-0323-J802#84	30i-B Designation of Number of Axes, 84 Axes
A02B-0323-J802#85	30i-B Designation of Number of Axes, 85 Axes
A02B-0323-J802#86	30i-B Designation of Number of Axes, 86 Axes
A02B-0323-J802#87	30i-B Designation of Number of Axes, 87 Axes
A02B-0323-J802#88	30i-B Designation of Number of Axes, 88 Axes
A02B-0323-J802#89	30i-B Designation of Number of Axes, 89 Axes
A02B-0323-J802#9	30i-B Designation of Number of Axes, 9 Axes
A02B-0323-J802#90	30i-B Designation of Number of Axes, 90 Axes
A02B-0323-J802#91	30i-B Designation of Number of Axes, 91 Axes
A02B-0323-J802#92	30i-B Designation of Number of Axes, 92 Axes
A02B-0323-J802#93	30i-B Designation of Number of Axes, 93 Axes
A02B-0323-J802#94	30i-B Designation of Number of Axes, 94 Axes
A02B-0323-J802#95	30i-B Designation of Number of Axes, 95 Axes
A02B-0323-J802#96	30i-B Designation of Number of Axes, 96 Axes
A02B-0326-J802#1	31i-B5 Designation of Number of Axes, 1 Axis
A02B-0326-J802#10	31i-B5 Designation of Number of Axes, 10 Axes
A02B-0326-J802#11	31i-B5 Designation of Number of Axes, 11 Axes
A02B-0326-J802#12	31i-B5 Designation of Number of Axes, 12 Axes
A02B-0326-J802#13	31i-B5 Designation of Number of Axes, 13 Axes
A02B-0326-J802#14	31i-B5 Designation of Number of Axes, 14 Axes
A02B-0326-J802#15	31i-B5 Designation of Number of Axes, 15 Axes
A02B-0326-J802#16	31i-B5 Designation of Number of Axes, 16 Axes
A02B-0326-J802#17	31i-B5 Designation of Number of Axes, 17 Axes
A02B-0326-J802#18	31i-B5 Designation of Number of Axes, 18 Axes
A02B-0326-J802#19	31i-B5 Designation of Number of Axes, 19 Axes
A02B-0326-J802#2	31i-B5 Designation of Number of Axes, 2 Axes

## Notice

Certain functions may require additional hardware, different CPU type or additional memory capacity or may cause compatibility issue with other functions. In case of doubt, contact your FANUC sales representative for additional information and support.

The information given in the FANUC manuals or original manufacturer documentation shall prevail. Technical data is subject to change without prior notice. No part of this document may be reproduced in any form. All rights reserved. © FANUC 2017

Specification	Description
A02B-0326-J802#20	31i-B5 Designation of Number of Axes, 20 Axes
A02B-0326-J802#21	31i-B5 Designation of Number of Axes, 21 Axes
A02B-0326-J802#22	31i-B5 Designation of Number of Axes, 22 Axes
A02B-0326-J802#23	31i-B5 Designation of Number of Axes, 23 Axes
A02B-0326-J802#24	31i-B5 Designation of Number of Axes, 24 Axes
A02B-0326-J802#25	31i-B5 Designation of Number of Axes, 25 Axes
A02B-0326-J802#26	31i-B5 Designation of Number of Axes, 26 Axes
A02B-0326-J802#3	31i-B5 Designation of Number of Axes, 3 Axes
A02B-0326-J802#4	31i-B5 Designation of Number of Axes, 4 Axes
A02B-0326-J802#5	31i-B5 Designation of Number of Axes, 5 Axes
A02B-0326-J802#6	31i-B5 Designation of Number of Axes, 6 Axes
A02B-0326-J802#7	31i-B5 Designation of Number of Axes, 7 Axes
A02B-0326-J802#8	31i-B5 Designation of Number of Axes, 8 Axes
A02B-0326-J802#9	31i-B5 Designation of Number of Axes, 9 Axes
A02B-0327-J802#1	31i-B Designation of Number of Axes, 1 Axis
A02B-0327-J802#10	31i-B Designation of Number of Axes, 10 Axes
A02B-0327-J802#11	31i-B Designation of Number of Axes, 11 Axes
A02B-0327-J802#12	31i-B Designation of Number of Axes, 12 Axes
A02B-0327-J802#13	31i-B Designation of Number of Axes, 13 Axes
A02B-0327-J802#14	31i-B Designation of Number of Axes, 14 Axes
A02B-0327-J802#15	31i-B Designation of Number of Axes, 15 Axes
A02B-0327-J802#16	31i-B Designation of Number of Axes, 16 Axes
A02B-0327-J802#17	31i-B Designation of Number of Axes, 17 Axes
A02B-0327-J802#18	31i-B Designation of Number of Axes, 18 Axes
A02B-0327-J802#19	31i-B Designation of Number of Axes, 19 Axes
A02B-0327-J802#2	31i-B Designation of Number of Axes, 2 Axes
A02B-0327-J802#20	31i-B Designation of Number of Axes, 20 Axes
A02B-0327-J802#21	31i-B Designation of Number of Axes, 21 Axes
A02B-0327-J802#22	31i-B Designation of Number of Axes, 22 Axes
A02B-0327-J802#23	31i-B Designation of Number of Axes, 23 Axes
A02B-0327-J802#24	31i-B Designation of Number of Axes, 24 Axes
A02B-0327-J802#25	31i-B Designation of Number of Axes, 25 Axes
A02B-0327-J802#26	31i-B Designation of Number of Axes, 26 Axes
A02B-0327-J802#3	31i-B Designation of Number of Axes, 3 Axes
A02B-0327-J802#4	31i-B Designation of Number of Axes, 4 Axes
A02B-0327-J802#5	31i-B Designation of Number of Axes, 5 Axes
A02B-0327-J802#6	31i-B Designation of Number of Axes, 6 Axes
A02B-0327-J802#7	31i-B Designation of Number of Axes, 7 Axes
A02B-0327-J802#8	31i-B Designation of Number of Axes, 8 Axes
A02B-0327-J802#9	31i-B Designation of Number of Axes, 9 Axes

**Notice**

Certain functions may require additional hardware, different CPU type or additional memory capacity or may cause compatibility issue with other functions. In case of doubt, contact your FANUC sales representative for additional information and support.

The information given in the FANUC manuals or original manufacturer documentation shall prevail. Technical data is subject to change without prior notice. No part of this document may be reproduced in any form. All rights reserved. © FANUC 2017

Specification	Description
A02B-0328-J802#1	32i-B Designation of Number of Axes, 1 Axis
A02B-0328-J802#10	32i-B Designation of Number of Axes, 10 Axes
A02B-0328-J802#2	32i-B Designation of Number of Axes, 2 Axes
A02B-0328-J802#3	32i-B Designation of Number of Axes, 3 Axes
A02B-0328-J802#4	32i-B Designation of Number of Axes, 4 Axes
A02B-0328-J802#5	32i-B Designation of Number of Axes, 5 Axes
A02B-0328-J802#6	32i-B Designation of Number of Axes, 6 Axes
A02B-0328-J802#7	32i-B Designation of Number of Axes, 7 Axes
A02B-0328-J802#8	32i-B Designation of Number of Axes, 8 Axes
A02B-0328-J802#9	32i-B Designation of Number of Axes, 9 Axes
A02B-0329-J802#1	30i-LB Designation of Number of Axes, 1 Axes
A02B-0329-J802#10	30i-LB Designation of Number of Axes, 10 Axes
A02B-0329-J802#11	30i-LB Designation of Number of Axes, 11 Axes
A02B-0329-J802#12	30i-LB Designation of Number of Axes, 12 Axes
A02B-0329-J802#13	30i-LB Designation of Number of Axes, 13 Axes
A02B-0329-J802#14	30i-LB Designation of Number of Axes, 14 Axes
A02B-0329-J802#15	30i-LB Designation of Number of Axes, 15 Axes
A02B-0329-J802#16	30i-LB Designation of Number of Axes, 16 Axes
A02B-0329-J802#17	30i-LB Designation of Number of Axes, 17 Axes
A02B-0329-J802#18	30i-LB Designation of Number of Axes, 18 Axes
A02B-0329-J802#19	30i-LB Designation of Number of Axes, 19 Axes
A02B-0329-J802#2	30i-LB Designation of Number of Axes, 2 Axes
A02B-0329-J802#20	30i-LB Designation of Number of Axes, 20 Axes
A02B-0329-J802#21	30i-LB Designation of Number of Axes, 21 Axes
A02B-0329-J802#22	30i-LB Designation of Number of Axes, 22 Axes
A02B-0329-J802#23	30i-LB Designation of Number of Axes, 23 Axes
A02B-0329-J802#24	30i-LB Designation of Number of Axes, 24 Axes
A02B-0329-J802#25	30i-LB Designation of Number of Axes, 25 Axes
A02B-0329-J802#26	30i-LB Designation of Number of Axes, 26 Axes
A02B-0329-J802#27	30i-LB Designation of Number of Axes, 27 Axes
A02B-0329-J802#28	30i-LB Designation of Number of Axes, 28 Axes
A02B-0329-J802#29	30i-LB Designation of Number of Axes, 29 Axes
A02B-0329-J802#3	30i-LB Designation of Number of Axes, 3 Axes
A02B-0329-J802#30	30i-LB Designation of Number of Axes, 30 Axes
A02B-0329-J802#31	30i-LB Designation of Number of Axes, 31 Axes
A02B-0329-J802#32	30i-LB Designation of Number of Axes, 32 Axes
A02B-0329-J802#4	30i-LB Designation of Number of Axes, 4 Axes
A02B-0329-J802#5	30i-LB Designation of Number of Axes, 5 Axes
A02B-0329-J802#6	30i-LB Designation of Number of Axes, 6 Axes
A02B-0329-J802#7	30i-LB Designation of Number of Axes, 7 Axes

**Notice**

Certain functions may require additional hardware, different CPU type or additional memory capacity or may cause compatibility issue with other functions. In case of doubt, contact your FANUC sales representative for additional information and support.

The information given in the FANUC manuals or original manufacturer documentation shall prevail. Technical data is subject to change without prior notice. No part of this document may be reproduced in any form. All rights reserved. © FANUC 2017

Specification	Description
A02B-0329-J802#8	30i-LB Designation of Number of Axes, 8 Axes
A02B-0329-J802#9	30i-LB Designation of Number of Axes, 9 Axes
A02B-0331-J802#1	30i-PB Designation of Number of Axes, 1 Axes
A02B-0331-J802#10	30i-PB Designation of Number of Axes, 10 Axes
A02B-0331-J802#11	30i-PB Designation of Number of Axes, 11 Axes
A02B-0331-J802#12	30i-PB Designation of Number of Axes, 12 Axes
A02B-0331-J802#13	30i-PB Designation of Number of Axes, 13 Axes
A02B-0331-J802#14	30i-PB Designation of Number of Axes, 14 Axes
A02B-0331-J802#15	30i-PB Designation of Number of Axes, 15 Axes
A02B-0331-J802#16	30i-PB Designation of Number of Axes, 16 Axes
A02B-0331-J802#17	30i-PB Designation of Number of Axes, 17 Axes
A02B-0331-J802#18	30i-PB Designation of Number of Axes, 18 Axes
A02B-0331-J802#19	30i-PB Designation of Number of Axes, 19 Axes
A02B-0331-J802#2	30i-PB Designation of Number of Axes, 2 Axes
A02B-0331-J802#20	30i-PB Designation of Number of Axes, 20 Axes
A02B-0331-J802#21	30i-PB Designation of Number of Axes, 21 Axes
A02B-0331-J802#22	30i-PB Designation of Number of Axes, 22 Axes
A02B-0331-J802#23	30i-PB Designation of Number of Axes, 23 Axes
A02B-0331-J802#24	30i-PB Designation of Number of Axes, 24 Axes
A02B-0331-J802#25	30i-PB Designation of Number of Axes, 25 Axes
A02B-0331-J802#26	30i-PB Designation of Number of Axes, 26 Axes
A02B-0331-J802#27	30i-PB Designation of Number of Axes, 27 Axes
A02B-0331-J802#28	30i-PB Designation of Number of Axes, 28 Axes
A02B-0331-J802#29	30i-PB Designation of Number of Axes, 29 Axes
A02B-0331-J802#3	30i-PB Designation of Number of Axes, 3 Axes
A02B-0331-J802#30	30i-PB Designation of Number of Axes, 30 Axes
A02B-0331-J802#31	30i-PB Designation of Number of Axes, 31 Axes
A02B-0331-J802#32	30i-PB Designation of Number of Axes, 32 Axes
A02B-0331-J802#4	30i-PB Designation of Number of Axes, 4 Axes
A02B-0331-J802#5	30i-PB Designation of Number of Axes, 5 Axes
A02B-0331-J802#6	30i-PB Designation of Number of Axes, 6 Axes
A02B-0331-J802#7	30i-PB Designation of Number of Axes, 7 Axes
A02B-0331-J802#8	30i-PB Designation of Number of Axes, 8 Axes
A02B-0331-J802#9	30i-PB Designation of Number of Axes, 9 Axes
A02B-0333-J802#1	35i-B Designation of Number of Axes, 1 Axis
A02B-0333-J802#10	35i-B Designation of Control Axes, 10 Axes
A02B-0333-J802#11	35i-B Designation of Control Axes, 11 Axes
A02B-0333-J802#12	35i-B Designation of Control Axes, 12 Axes
A02B-0333-J802#13	35i-B Designation of Control Axes, 13 Axes
A02B-0333-J802#14	35i-B Designation of Control Axes, 14 Axes

**Notice**

Certain functions may require additional hardware, different CPU type or additional memory capacity or may cause compatibility issue with other functions. In case of doubt, contact your FANUC sales representative for additional information and support.

The information given in the FANUC manuals or original manufacturer documentation shall prevail. Technical data is subject to change without prior notice. No part of this document may be reproduced in any form. All rights reserved. © FANUC 2017

Specification	Description
A02B-0333-J802#15	35i-B Designation of Control Axes, 15 Axes
A02B-0333-J802#16	35i-B Designation of Control Axes, 16 Axes
A02B-0333-J802#2	35i-B Designation of Number of Axes, 2 Axes
A02B-0333-J802#3	35i-B Designation of Number of Axes, 3 Axes
A02B-0333-J802#4	35i-B Designation of Number of Axes, 4 Axes
A02B-0333-J802#5	35i-B Designation of Number of Axes, 5 Axes
A02B-0333-J802#6	35i-B Designation of Number of Axes, 6 Axes
A02B-0333-J802#7	35i-B Designation of Control Axes, 7 Axes
A02B-0333-J802#8	35i-B Designation of Control Axes, 8 Axes
A02B-0333-J802#9	35i-B Designation of Control Axes, 9 Axes
A02B-0334-J802#1	PM i-A Designation of Number of Axes, 1 Axis
A02B-0334-J802#10	PM i-A Designation of Number of Axes, 10 Axes
A02B-0334-J802#11	PM i-A Designation of Number of Axes, 11 Axes
A02B-0334-J802#12	PM i-A Designation of Number of Axes, 12 Axes
A02B-0334-J802#13	PM i-A Designation of Number of Axes, 13 Axes
A02B-0334-J802#14	PM i-A Designation of Number of Axes, 14 Axes
A02B-0334-J802#15	PM i-A Designation of Number of Axes, 15 Axes
A02B-0334-J802#16	PM i-A Designation of Number of Axes, 16 Axes
A02B-0334-J802#17	PM i-A Designation of Number of Axes, 17 Axes
A02B-0334-J802#18	PM i-A Designation of Number of Axes, 18 Axes
A02B-0334-J802#19	PM i-A Designation of Number of Axes, 19 Axes
A02B-0334-J802#2	PM i-A Designation of Number of Axes, 2 Axes
A02B-0334-J802#20	PM i-A Designation of Number of Axes, 20 Axes
A02B-0334-J802#21	PM i-A Designation of Number of Axes, 21 Axes
A02B-0334-J802#22	PM i-A Designation of Number of Axes, 22 Axes
A02B-0334-J802#23	PM i-A Designation of Number of Axes, 23 Axes
A02B-0334-J802#24	PM i-A Designation of Number of Axes, 24 Axes
A02B-0334-J802#25	PM i-A Designation of Number of Axes, 25 Axes
A02B-0334-J802#26	PM i-A Designation of Number of Axes, 26 Axes
A02B-0334-J802#27	PM i-A Designation of Number of Axes, 27 Axes
A02B-0334-J802#28	PM i-A Designation of Number of Axes, 28 Axes
A02B-0334-J802#29	PM i-A Designation of Number of Axes, 29 Axes
A02B-0334-J802#3	PM i-A Designation of Number of Axes, 3 Axes
A02B-0334-J802#30	PM i-A Designation of Number of Axes, 30 Axes
A02B-0334-J802#31	PM i-A Designation of Number of Axes, 31 Axes
A02B-0334-J802#32	PM i-A Designation of Number of Axes, 32 Axes
A02B-0334-J802#4	PM i-A Designation of Number of Axes, 4 Axes
A02B-0334-J802#5	PM i-A Designation of Number of Axes, 5 Axes
A02B-0334-J802#6	PM i-A Designation of Number of Axes, 6 Axes
A02B-0334-J802#7	PM i-A Designation of Number of Axes, 7 Axes

**Notice**

Certain functions may require additional hardware, different CPU type or additional memory capacity or may cause compatibility issue with other functions. In case of doubt, contact your FANUC sales representative for additional information and support.

The information given in the FANUC manuals or original manufacturer documentation shall prevail. Technical data is subject to change without prior notice. No part of this document may be reproduced in any form. All rights reserved. © FANUC 2017

# 030

Specification	Description
A02B-0334-J802#8	PM i-A Designation of Number of Axes, 8 Axes
A02B-0334-J802#9	PM i-A Designation of Number of Axes, 9 Axes

## Notice

Certain functions may require additional hardware, different CPU type or additional memory capacity or may cause compatibility issue with other functions. In case of doubt, contact your FANUC sales representative for additional information and support.

The information given in the FANUC manuals or original manufacturer documentation shall prevail. Technical data is subject to change without prior notice. No part of this document may be reproduced in any form. All rights reserved. © FANUC 2017

# 031

## Controlled Axis

# Designation of Machine Groups

This function specifies the number of machine groups or axes groups that the CNC can control.

If multiple paths are used, several paths can be formed into a group. By doing so, the group can share data, and if an alarm is issued with a path, the other path(s) in the group can be stopped. A group of those paths is referred to as a machine group.

Up to three groups can be used, depending on the type of CNC.

The following items are impacted by the machine group configuration:

- Emergency stop signal
- RESET on the MDI
- Operation performed when an alarm is issued

## Ordering Information

Specification	Description
A02B-0323-S836#1	30i-B Designation of Machine Groups, 1 Group
A02B-0323-S836#2	30i-B Designation of Machine Groups, 2 Groups
A02B-0323-S836#3	30i-B Designation of Machine Groups, 3 Groups
A02B-0326-S836#1	31i-B5 Designation of Machine Groups, 1 Group
A02B-0326-S836#2	31i-B5 Designation of Machine Groups, 2 Groups
A02B-0326-S836#3	31i-B5 Designation of Machine Groups, 3 Groups
A02B-0327-S836#1	31i-B Designation of Machine Groups, 1 Group
A02B-0327-S836#2	31i-B Designation of Machine Groups, 2 Groups
A02B-0327-S836#3	31i-B Designation of Machine Groups, 3 Groups
A02B-0328-S836#1	32i-B Designation of Machine Groups, 1 Group
A02B-0328-S836#2	32i-B Designation of Machine Groups, 2 Groups
A02B-0333-S836#1	35i-B Designation of Machine Groups, 1 Group
A02B-0333-S836#2	35i-B Designation of Machine Groups, 2 Groups
A02B-0334-S836#1	PM i-A Designation of Machine Groups, 1 Group
A02B-0334-S836#2	PM i-A Designation of Machine Groups, 2 Groups
A02B-0334-S836#3	PM i-A Designation of Machine Groups, 3 Groups
A02B-0339-S836#1	0i-TF Number of Machining Groups: 1 Group
A02B-0339-S836#2	0i-TF Number of Machining Groups: 2 Groups
A02B-0339-S836#3	0i-TF Number of Machining Groups: 3 Groups
A02B-0340-S836#1	0i-MF Number of Machining Groups: 1 Group
A02B-0340-S836#2	0i-MF Number of Machining Groups: 2 Groups
A02B-0340-S836#3	0i-MF Number of Machining Groups: 3 Groups

### Notice

Certain functions may require additional hardware, different CPU type or additional memory capacity or may cause compatibility issue with other functions. In case of doubt, contact your FANUC sales representative for additional information and support.

The information given in the FANUC manuals or original manufacturer documentation shall prevail. Technical data is subject to change without prior notice. No part of this document may be reproduced in any form. All rights reserved. © FANUC 2017



# 032

## Controlled Axis

# Designation of Control Paths

This function specifies the number of controlled path for the CNC.

A path represents a group of axes that are controlled by the same NC program.

Up to 10 paths can be used, depending on the type of NC system. A path for loader control is also counted as a path.

## Ordering Information

Specification	Description
A02B-0323-S801#1	30i-B Designation of Control Paths, 1 Path
A02B-0323-S801#10	30i-B Designation of Control Paths, 10 Paths
A02B-0323-S801#11	30i-B Designation of Control Paths, 11 Paths
A02B-0323-S801#12	30i-B Designation of Control Paths, 12 Paths
A02B-0323-S801#13	30i-B Designation of Control Paths, 13 Paths
A02B-0323-S801#14	30i-B Designation of Control Paths, 14 Paths
A02B-0323-S801#15	30i-B Designation of Control Paths, 15 Paths
A02B-0323-S801#2	30i-B Designation of Control Paths, 2 Paths
A02B-0323-S801#3	30i-B Designation of Control Paths, 3 Paths
A02B-0323-S801#4	30i-B Designation of Control Paths, 4 Paths
A02B-0323-S801#5	30i-B Designation of Control Paths, 5 Paths
A02B-0323-S801#6	30i-B Designation of Control Paths, 6 Paths
A02B-0323-S801#7	30i-B Designation of Control Paths, 7 Paths
A02B-0323-S801#8	30i-B Designation of Control Paths, 8 Paths
A02B-0323-S801#9	30i-B Designation of Control Paths, 9 Paths
A02B-0326-S801#1	31i-B5 Designation of Control Paths, 1 Path
A02B-0326-S801#2	31i-B5 Designation of Control Paths, 2 Paths
A02B-0326-S801#3	31i-B5 Designation of Control Paths, 3 Paths
A02B-0326-S801#4	31i-B5 Designation of Control Paths, 4 Paths
A02B-0326-S801#5	31i-B5 Designation of Control Paths, 5 Paths
A02B-0326-S801#6	31i-B5 Designation of Control Paths, 6 Paths
A02B-0327-S801#1	31i-B Designation of Control Paths, 1 Path
A02B-0327-S801#2	31i-B Designation of Control Paths, 2 Paths
A02B-0327-S801#3	31i-B Designation of Control Paths, 3 Paths
A02B-0327-S801#4	31i-B Designation of Control Paths, 4 Paths
A02B-0327-S801#5	31i-B Designation of Control Paths, 5 Paths
A02B-0327-S801#6	31i-B Designation of Control Paths, 6 Paths
A02B-0328-S801#1	32i-B Designation of Control Paths, 1 Path
A02B-0328-S801#2	32i-B Designation of Control Paths, 2 Paths

### Notice

Certain functions may require additional hardware, different CPU type or additional memory capacity or may cause compatibility issue with other functions. In case of doubt, contact your FANUC sales representative for additional information and support.

The information given in the FANUC manuals or original manufacturer documentation shall prevail. Technical data is subject to change without prior notice. No part of this document may be reproduced in any form. All rights reserved. © FANUC 2017

# 033

Specification	Description
A02B-0333-S801#1	35i-B Designation of Control Paths, 1 Path
A02B-0333-S801#2	35i-B Designation of Control Paths, 2 Paths
A02B-0333-S801#3	35i-B Designation of Control Paths, 3 Paths
A02B-0333-S801#4	35i-B Designation of Control Paths, 4 Paths
A02B-0334-S801#1	PM i-A Designation of Control Paths, 1 Path
A02B-0334-S801#2	PM i-A Designation of Control Paths, 2 Paths
A02B-0334-S801#3	PM i-A Designation of Control Paths, 3 Paths
A02B-0334-S801#4	PM i-A Designation of Control Paths, 4 Paths
A02B-0339-S801#1	0i-TF Number of Control Paths: 1 Path
A02B-0339-S801#2	0i-TF Number of Control Paths: 2 Paths
A02B-0340-S801#1	0i-MF Number of Control Paths: 1 Path
A02B-0340-S801#2	0i-MF Number of Control Paths: 2 Paths

## Notice

Certain functions may require additional hardware, different CPU type or additional memory capacity or may cause compatibility issue with other functions. In case of doubt, contact your FANUC sales representative for additional information and support.

The information given in the FANUC manuals or original manufacturer documentation shall prevail. Technical data is subject to change without prior notice. No part of this document may be reproduced in any form. All rights reserved. © FANUC 2017

# 034

## Controlled Axis

# Controllable Axes Expansion

This function increases the maximum number of axes controllable by the CNC.

## Ordering Information

Specification	Description
A02B-0323-J801	30i-B Controlled Axes Expansion
A02B-0326-J801	31i-B5 Controlled Axes Expansion
A02B-0327-J801	31i-B Controlled Axes Expansion
A02B-0328-J801	32i-B Controlled Axes Expansion
A02B-0329-J801	30i-LB Controllable Axes Expansion
A02B-0331-J801	30i-PB Controllable Axes Expansion
A02B-0339-R689	0i-TF Controllable Axes Expansion
A02B-0340-R689	0i-MF Controllable Axes Expansion

### Notice

Certain functions may require additional hardware, different CPU type or additional memory capacity or may cause compatibility issue with other functions. In case of doubt, contact your FANUC sales representative for additional information and support.

The information given in the FANUC manuals or original manufacturer documentation shall prevail. Technical data is subject to change without prior notice. No part of this document may be reproduced in any form. All rights reserved. © FANUC 2017

# 035

## Controlled Axis

# Simultaneously Controlled Axes Expansion

This function defines the maximum number of axes that can be controlled simultaneously by the CNC.

## Ordering Information

Specification	Description
A02B-0323-J803	30i-B Simultaneously Controlled Axes Expansion
A02B-0326-J803	31i-B5 Simultaneously Controlled Axes Expansion
A02B-0327-J803	31i-B Simultaneously Controlled Axes Expansion
A02B-0328-J803	32i-B Simultaneously Controlled Axes Expansion
A02B-0329-J803	30i-LB Simultaneously Controlled Axes Expansion
A02B-0331-J803	30i-PB Simultaneously Controlled Axes Expansion
A02B-0333-J803	35i-B Simultaneously Controlled Axes Expansion (Max. 4 Axes)

### Notice

Certain functions may require additional hardware, different CPU type or additional memory capacity or may cause compatibility issue with other functions. In case of doubt, contact your FANUC sales representative for additional information and support.

The information given in the FANUC manuals or original manufacturer documentation shall prevail. Technical data is subject to change without prior notice. No part of this document may be reproduced in any form. All rights reserved. © FANUC 2017

# 036

## Controlled Axis

# Axis Control by PMC

## Features

This function allows the ladder logic program of the Programmable Machine Controller (PMC) to control up to 4 axes per path as independent axes from the programmed axes of the CNC.

This function is a basic function in FANUC Series 0i-F.

## Benefits

- Reduction of the machining cycle time by operating automation devices simultaneously with the part program execution
- Simple mean to add peripheral automation devices such as pallets changers, tool changers, turrets, conveyors, etc.
- Easy activation through M code or push button on the operator panel
- Up to 4 devices can be automated simultaneously
- Ladder logic program resides in non volatile ROM which is protected from accidental changes by the operator

## Ordering Information

Specification	Description
A02B-0323-J804	30i-B Axis Control by PMC
A02B-0326-J804	31i-B5 Axis Control by PMC
A02B-0327-J804	31i-B Axis Control by PMC
A02B-0328-J804	32i-B Axis Control by PMC

### Notice

Certain functions may require additional hardware, different CPU type or additional memory capacity or may cause compatibility issue with other functions. In case of doubt, contact your FANUC sales representative for additional information and support.

The information given in the FANUC manuals or original manufacturer documentation shall prevail. Technical data is subject to change without prior notice. No part of this document may be reproduced in any form. All rights reserved. © FANUC 2017

# 037

## Controlled Axis

# Designation of Spindle Axes

This function increases the total number of spindle axes that can be controlled by the CNC.

## Ordering Information

Specification	Description
A02B-0323-S837#1	30i-B Designation of Spindle Axes, 1 Spindle
A02B-0323-S837#10	30i-B Designation of Spindle Axes, 10 Spindles
A02B-0323-S837#11	30i-B Designation of Spindle Axes, 11 Spindles
A02B-0323-S837#12	30i-B Designation of Spindle Axes, 12 Spindles
A02B-0323-S837#13	30i-B Designation of Spindle Axes, 13 Spindles
A02B-0323-S837#14	30i-B Designation of Spindle Axes, 14 Spindles
A02B-0323-S837#15	30i-B Designation of Spindle Axes, 15 Spindles
A02B-0323-S837#16	30i-B Designation of Spindle Axes, 16 Spindles
A02B-0323-S837#17	30i-B Designation of Spindle Axes, 17 Spindles
A02B-0323-S837#18	30i-B Designation of Spindle Axes, 18 Spindles
A02B-0323-S837#19	30i-B Designation of Spindle Axes, 19 Spindles
A02B-0323-S837#2	30i-B Designation of Spindle Axes, 2 Spindles
A02B-0323-S837#20	30i-B Designation of Spindle Axes, 20 Spindles
A02B-0323-S837#21	30i-B Designation of Spindle Axes, 21 Spindles
A02B-0323-S837#22	30i-B Designation of Spindle Axes, 22 Spindles
A02B-0323-S837#23	30i-B Designation of Spindle Axes, 23 Spindles
A02B-0323-S837#24	30i-B Designation of Spindle Axes, 24 Spindles
A02B-0323-S837#3	30i-B Designation of Spindle Axes, 3 Spindles
A02B-0323-S837#4	30i-B Designation of Spindle Axes, 4 Spindles
A02B-0323-S837#5	30i-B Designation of Spindle Axes, 5 Spindles
A02B-0323-S837#6	30i-B Designation of Spindle Axes, 6 Spindles
A02B-0323-S837#7	30i-B Designation of Spindle Axes, 7 Spindles
A02B-0323-S837#8	30i-B Designation of Spindle Axes, 8 Spindles
A02B-0323-S837#9	30i-B Designation of Spindle Axes, 9 Spindles
A02B-0326-S837#1	31i-B5 Designation of Spindle Axes, 1 Spindle
A02B-0326-S837#2	31i-B5 Designation of Spindle Axes, 2 Spindles
A02B-0326-S837#3	31i-B5 Designation of Spindle Axes, 3 Spindles
A02B-0326-S837#4	31i-B5 Designation of Spindle Axes, 4 Spindles
A02B-0326-S837#5	31i-B5 Designation of Spindle Axes, 5 Spindles
A02B-0326-S837#6	31i-B5 Designation of Spindle Axes, 6 Spindles
A02B-0326-S837#7	31i-B5 Designation of Spindle Axes, 7 Spindles
A02B-0326-S837#8	31i-B5 Designation of Spindle Axes, 8 Spindles
A02B-0327-S837#1	31i-B Designation of Spindle Axes, 1 Spindle

### Notice

Certain functions may require additional hardware, different CPU type or additional memory capacity or may cause compatibility issue with other functions. In case of doubt, contact your FANUC sales representative for additional information and support.

The information given in the FANUC manuals or original manufacturer documentation shall prevail. Technical data is subject to change without prior notice. No part of this document may be reproduced in any form. All rights reserved. © FANUC 2017

# 038

Specification	Description
A02B-0327-S837#2	31i-B Designation of Spindle Axes, 2 Spindles
A02B-0327-S837#3	31i-B Designation of Spindle Axes, 3 Spindles
A02B-0327-S837#4	31i-B Designation of Spindle Axes, 4 Spindles
A02B-0327-S837#5	31i-B Designation of Spindle Axes, 5 Spindles
A02B-0327-S837#6	31i-B Designation of Spindle Axes, 6 Spindles
A02B-0327-S837#7	31i-B Designation of Spindle Axes, 7 Spindles
A02B-0327-S837#8	31i-B Designation of Spindle Axes, 8 Spindles
A02B-0328-S837#1	32i-B Designation of Spindle Axes, 1 Spindle
A02B-0328-S837#2	32i-B Designation of Spindle Axes, 2 Spindles
A02B-0328-S837#3	32i-B Designation of Spindle Axes, 3 Spindles
A02B-0328-S837#4	32i-B Designation of Spindle Axes, 4 Spindles
A02B-0328-S837#5	32i-B Designation of Spindle Axes, 5 Spindles
A02B-0328-S837#6	32i-B Designation of Spindle Axes, 6 Spindles
A02B-0333-S837#1	35i-B Designation of Spindle Axes, 1 Spindle
A02B-0333-S837#2	35i-B Designation of Spindle Axes, 2 Spindles
A02B-0333-S837#3	35i-B Designation of Spindle Axes, 3 Spindles
A02B-0333-S837#4	35i-B Designation of Spindle Axes, 4 Spindles

## Notice

Certain functions may require additional hardware, different CPU type or additional memory capacity or may cause compatibility issue with other functions. In case of doubt, contact your FANUC sales representative for additional information and support.

The information given in the FANUC manuals or original manufacturer documentation shall prevail. Technical data is subject to change without prior notice. No part of this document may be reproduced in any form. All rights reserved. © FANUC 2017

# 039

## Controlled Axis

# Cs Contouring Control

## Features

The Cs Contouring function controls the position of the serial spindle using the spindle motor in conjunction with a dedicated detector mounted on the spindle.

The Cs contouring control function provides a higher precision than the spindle positioning function and enables positioning with other servo axes. Namely, the Cs contouring control function enables linear interpolation between the spindle and servo axes.

The speed of the serial spindle is controlled by the spindle speed control function, while the spindle positioning is controlled by the Cs contouring control function ("spindle contouring control"). Spindle speed control rotates the spindle using the velocity command, while the spindle contour control rotates the spindle using the move command.

Switching between spindle speed control and Cs contouring control is performed by signals set in the PMC. In the Cs contouring control mode, the Cs contouring control axis can be operated either manually or automatically, in the same way as normal servo axes.

This function is a basic function in FANUC Series 0i-MF and 0i-TF.

## Benefits

- High-precision positioning of the spindle
- Interpolation between the spindle axis and the feed axes

## Ordering Information

Specification	Description
A02B-0323-J852	30i-B CS Contour Control
A02B-0326-J852	31i-B5 CS Contour Control
A02B-0327-J852	31i-B CS Contour Control
A02B-0328-J852	32i-B CS Contour Control

### Notice

Certain functions may require additional hardware, different CPU type or additional memory capacity or may cause compatibility issue with other functions. In case of doubt, contact your FANUC sales representative for additional information and support.

The information given in the FANUC manuals or original manufacturer documentation shall prevail. Technical data is subject to change without prior notice. No part of this document may be reproduced in any form. All rights reserved. © FANUC 2017



# 040

## Controlled Axis

# Loader Control Function

## Features

The Loader Control Function is used to control peripheral devices such as a loader that perform non-machining operations. With this function, the path for performing a loader control is added besides the machining paths. Up to 4 feed axes can be controlled in a loader path.

## Benefits

- Simplifies programming of peripheral devices

## Ordering Information

Specification	Description
A02B-0323-R417	30i-B Function for Loader Control
A02B-0326-R417	31i-B5 Function for Loader Control
A02B-0327-R417	31i-B Function for Loader Control
A02B-0328-R417	32i-B Function for Loader Control
A02B-0339-R417	0i-TF Function for Loader Control
A02B-0340-R417	0i-MF Function for Loader Control

### Notice

Certain functions may require additional hardware, different CPU type or additional memory capacity or may cause compatibility issue with other functions. In case of doubt, contact your FANUC sales representative for additional information and support.

The information given in the FANUC manuals or original manufacturer documentation shall prevail. Technical data is subject to change without prior notice. No part of this document may be reproduced in any form. All rights reserved. © FANUC 2017

# 041

## Controlled Axis

# Addition of Loader Control Path

## Features

The Addition of Loader Control Path function enables to add a second loader control path for the control of peripheral axes. Up to 3 feed axes can be controlled in each loader path.

## Note

The Loader Control Function is required to use this function.

## Benefits

- Extend the application range of the Loader Control Function

## Ordering Information

Specification	Description
A02B-0323-R418	30i-B Addition of Loader Control Path
A02B-0326-R418	31i-B5 Addition of Loader Control Path
A02B-0327-R418	31i-B Addition of Loader Control Path
A02B-0328-R418	32i-B Addition of Loader Control Path
A02B-0339-R418	0i-TF Addition of Loader Control Path
A02B-0340-R418	0i-MF Addition of Loader Control Path

### Notice

Certain functions may require additional hardware, different CPU type or additional memory capacity or may cause compatibility issue with other functions. In case of doubt, contact your FANUC sales representative for additional information and support.

The information given in the FANUC manuals or original manufacturer documentation shall prevail. Technical data is subject to change without prior notice. No part of this document may be reproduced in any form. All rights reserved. © FANUC 2017

# 042

## Controlled Axis

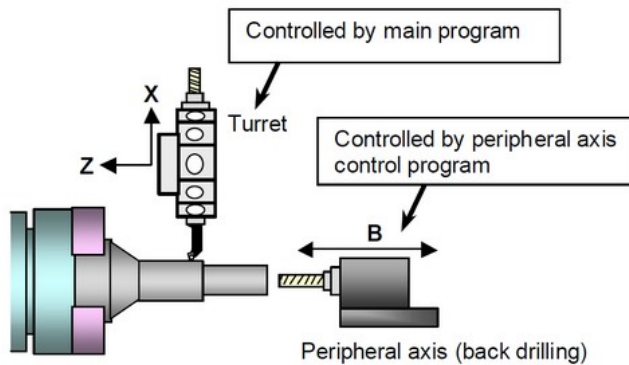

# Peripheral Axis Control

## Features

In addition to a main program, another program can execute during the automatic operation of the CNC. In this case, peripheral axes such as loader and back drilling can be controlled in parallel with a main program.

The Peripheral Axis Control function has three control groups:

- Peripheral axis control group 1
- Peripheral axis control group 2
- Peripheral axis control group 3

Each group can run independently. Therefore, in a multi-path system, peripheral axis control can be applied to each path independently by assigning different control groups for each path.

## Benefits

- Increase of machine efficiency and productivity
- Speed up programming and CNC commissioning
- Complex motion commands are easier and faster to program

## Ordering Information

Specification	Description
A02B-0323-R725	30i-B Peripheral Axis Control
A02B-0326-R725	31i-B5 Peripheral Axis Control
A02B-0327-R725	31i-B Peripheral Axis Control
A02B-0328-R725	32i-B Peripheral Axis Control
A02B-0339-R725	0i-TF Peripheral Axis Control
A02B-0340-R725	0i-MF Peripheral Axis Control

### Notice

Certain functions may require additional hardware, different CPU type or additional memory capacity or may cause compatibility issue with other functions. In case of doubt, contact your FANUC sales representative for additional information and support.

The information given in the FANUC manuals or original manufacturer documentation shall prevail. Technical data is subject to change without prior notice. No part of this document may be reproduced in any form. All rights reserved. © FANUC 2017

# 043

## Controlled Axis

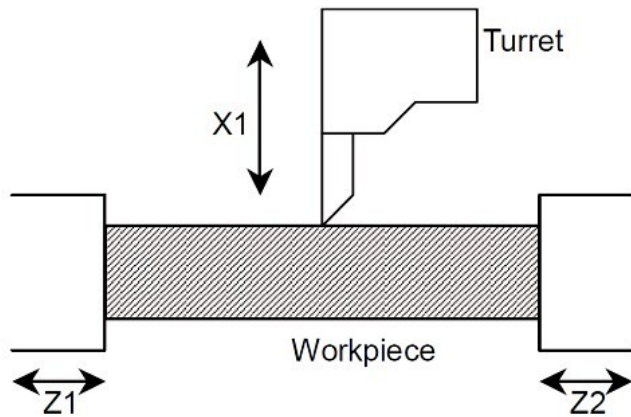

Synchronize Z2 in path 2 with Z1 in path1

## Synchronous and Composite Control

### Features

The Synchronous and Composite Control function enables an arbitrary axis of one path to be synchronized with an arbitrary axis of another path (synchronous control). In a multi-path control, movements are usually made on the axes of a path according to a move command for the path (independent control in each path).

With Synchronous and Composite Control, a move command for an arbitrary axis of one path and a move command for an arbitrary axis of another path can be exchanged with each other to make a movement on each axis (composite control).

By applying a move command for an axis (master axis) to a different arbitrary axis (slave axis), the movements on the two axes can be synchronized with each other. Whether to synchronize the movement on a slave axis with the move command for the master axis or make a movement on a slave according to the command for the slave can be chosen using the signal (synchronous control selection signal) from the PMC.

A move command for an arbitrary axis of one path and a move command for an arbitrary axis of another path can be exchanged with each other to make a movement on each axis.

### Benefits

- Increase of machine efficiency and productivity
- Speed up programming and CNC commissioning
- Easier and faster programming
- Allows complex commands and synchronization between paths

### Ordering Information

Specification	Description
A02B-0323-S816	30i-B Synchronous and Composite Control for Multi-Path System
A02B-0326-S816	31i-B5 Synchronous and Composite Control for Multi-Path System
A02B-0327-S816	31i-B Synchronous and Composite Control for Multi-Path System
A02B-0328-S816	32i-B Synchronous and Composite Control for Multi-Path System
A02B-0339-S816	0i-TF Synchronous and Composite Control
A02B-0340-S816	0i-MF Synchronous and Composite Control

#### Notice

Certain functions may require additional hardware, different CPU type or additional memory capacity or may cause compatibility issue with other functions. In case of doubt, contact your FANUC sales representative for additional information and support.

The information given in the FANUC manuals or original manufacturer documentation shall prevail. Technical data is subject to change without prior notice. No part of this document may be reproduced in any form. All rights reserved. © FANUC 2017

# 044

## Controlled Axis

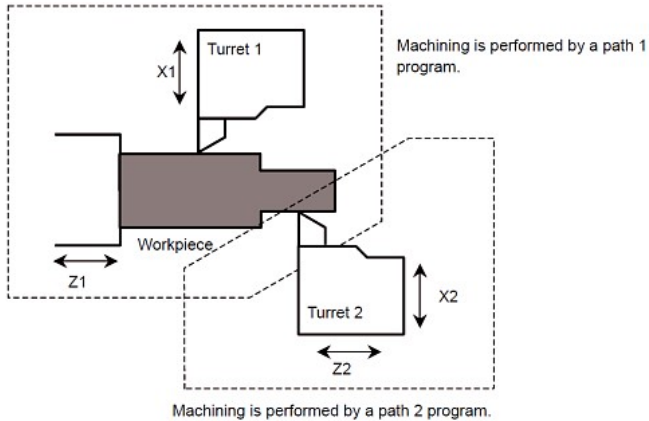

## Superimposed Control

### Features

Superimposed Control enables the travel distance on an arbitrary axis of one path to be superimposed on the travel distance on an arbitrary axis of another path. In multi-path control, usually, movements are made on the axes of path 1 according to a move command for path 1, and movements are made on the axes of path 2 according to a move command for path 2 (independent control in each path).

Superimposed control is very similar to synchronous control. In superimposed control however, a movement on the slave axis can be specified with a command for the path to which the slave axis belongs. The master axis and slave axis may belong to the same path, or the master axis may belong to one axis and the slave axis may belong to another. Moreover, multiple slave axes can be specified for one master axis. With the help of parameter settings, the move directions on the master axis and slave axis can be reversed from each other.

Example: in the image a move command for the Z1 axis of path 1 is superimposed on the travel distance on the Z2 axis of path 2.

### Benefits

- Increase of machine efficiency and productivity
- Speed up programming and CNC commissioning
- Complex motion commands are easier and faster to program

### Ordering Information

Specification	Description
A02B-0323-S818	30i-B Superimposed Control
A02B-0326-S818	31i-B5 Superimposed Control
A02B-0327-S818	31i-B Superimposed Control
A02B-0328-S818	32i-B Superimposed Control
A02B-0339-S818	0i-TF Superimposed Control
A02B-0340-S818	0i-MF Superimposed Control

#### Notice

Certain functions may require additional hardware, different CPU type or additional memory capacity or may cause compatibility issue with other functions. In case of doubt, contact your FANUC sales representative for additional information and support.

The information given in the FANUC manuals or original manufacturer documentation shall prevail. Technical data is subject to change without prior notice. No part of this document may be reproduced in any form. All rights reserved. © FANUC 2017

# 045

## Controlled Axis

# Superimposed Control A

---

## Features

For a slave axis under superimposed control, a travel distance specified by the program for the master axis path is added to a travel distance specified by the program for the slave axis path.

As a consequence, the actual speed on a slave axis is significantly higher than the ordinary speed ("ordinary speed" means a speed such as a parameter-set rapid traverse rate).

To prevent this, feedrates and a linear acceleration / deceleration time constant in rapid traverse can be set for use only during superimposed control with this function.

## Benefits

- Simplifies the control in superimposed mode

## Ordering Information

Specification	Description
A02B-0339-R538	0i-TF Superimposed Control A
A02B-0340-R538	0i-MF Superimposed Control A

### Notice

Certain functions may require additional hardware, different CPU type or additional memory capacity or may cause compatibility issue with other functions. In case of doubt, contact your FANUC sales representative for additional information and support.

The information given in the FANUC manuals or original manufacturer documentation shall prevail. Technical data is subject to change without prior notice. No part of this document may be reproduced in any form. All rights reserved. © FANUC 2017

# 046

## Controlled Axis

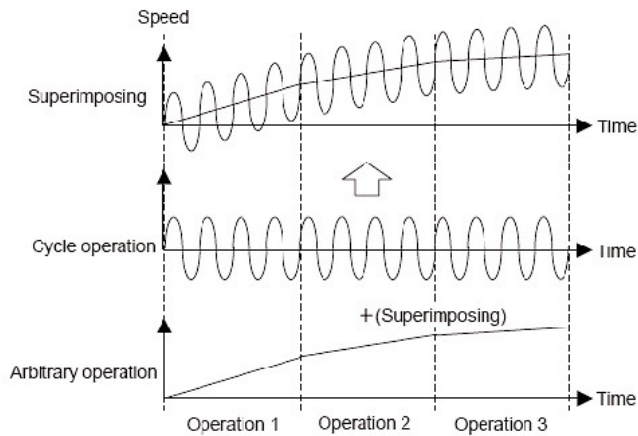

# Superimposed Control for High-Speed Cycle Machining

## Features

The Superimposed Control for High-Speed Cycle Machining function can perform superimposing upon an axis executing high-speed cycle machining or high-speed binary operation, from another path.

Independent arbitrary operation (cutting command) can be superimposed on a cycle operation that uses high-speed cycle machining (contour command or oscillation command).

Learning control can be used in high-speed cycle machining and high-speed binary operation.

## Benefits

- Increase of machine efficiency and productivity
- Speed up programming and CNC commissioning
- Easier and faster programming
- Allows complex movements issued from the superimposition of arbitrary moves with high-speed operations

## Ordering Information

Specification	Description
A02B-0323-R554	30i-B High-Speed Cycle Machining - Superimposed Control
A02B-0326-R554	31i-B5 High-Speed Cycle Machining - Superimposed Control
A02B-0327-R554	31i-B High-Speed Cycle Machining - Superimposed Control

### Notice

Certain functions may require additional hardware, different CPU type or additional memory capacity or may cause compatibility issue with other functions. In case of doubt, contact your FANUC sales representative for additional information and support.

The information given in the FANUC manuals or original manufacturer documentation shall prevail. Technical data is subject to change without prior notice. No part of this document may be reproduced in any form. All rights reserved. © FANUC 2017

# 047

## Controlled Axis

# Synchronous, Composite and Superimposed Control by Program Command

## Features

The Synchronous, Composite and Superimposed Control function can be started or canceled using G-codes in the part program instead of being activated through digital input signals.

It is also possible to perform these controls using digital input signals in addition.

## Example

- G51.4 P\_ Q\_ (L\_); Start synchronous control
- G50.4 Q\_ ; Cancel synchronous control
- G51.5 P\_ Q\_ ; Start composite control
- G50.5 P\_ Q\_ ; Cancel composite control
- G51.6 P\_ Q\_ ; Start superimposed control
- G50.6 Q\_ ; Cancel superimposed control

## Benefits

- Flexibility of the machine configuration
- Behaviour change without writing a specific PMC program
- Compatibility with Series 16i function

## Ordering Information

Specification	Description
A02B-0323-S890	30i-B Synchronous, Composite and Superimposed Control by CNC Program
A02B-0326-S890	31i-B5 Synchronous, Composite and Superimposed control by CNC Program
A02B-0327-S890	31i-B Synchronous, Composite and Superimposed Control by CNC Program
A02B-0328-S890	32i-B Synchronous, Composite and Superimposed Control by CNC Program
A02B-0339-S890	0i-TF Synchronous, Composite & Super Imposed Control by CNC Program
A02B-0340-S890	0i-MF Synchronous, Composite & Super Imposed Control by CNC Program

### Notice

Certain functions may require additional hardware, different CPU type or additional memory capacity or may cause compatibility issue with other functions. In case of doubt, contact your FANUC sales representative for additional information and support.

The information given in the FANUC manuals or original manufacturer documentation shall prevail. Technical data is subject to change without prior notice. No part of this document may be reproduced in any form. All rights reserved. © FANUC 2017



# 048

## Controlled Axis

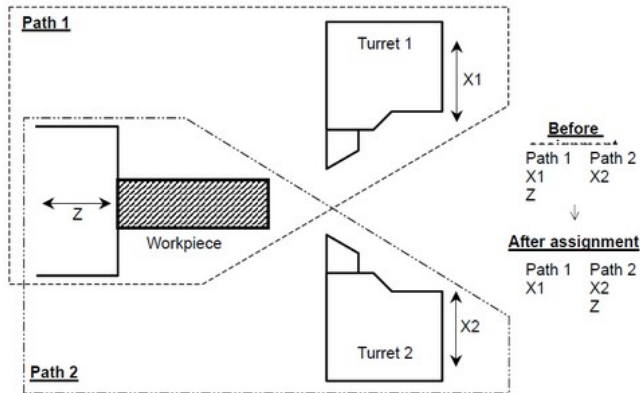

# Flexible Path Axis Assignment

## Features

The Flexible Path Axis Assignment function enables to disconnect each control axis from the control of each path and to assign the axis as a controlled axis to other path.

When using this function, an axis can be controlled in multiple paths.

The use of a dummy axis as intermediate is not required when using this function, as axis configuration can be changed directly.

## Benefits

- High flexibility of the machine configuration and axis usage
- Increase of machine efficiency and productivity
- Speed up programming and CNC commissioning

## Ordering Information

Specification	Description
A02B-0323-R607	30i-B Flexible Path Axis Assignment
A02B-0326-R607	31i-B5 Flexible Path Axis Assignment
A02B-0327-R607	31i-B Flexible Path Axis Assignment
A02B-0328-R607	32i-B Flexible Path Axis Assignment
A02B-0333-R404	35i-B Flexible Path Axis Assignment
A02B-0339-R607	0i-TF Flexible Path Axis Assignment
A02B-0340-R607	0i-MF Flexible Path Axis Assignment

### Notice

Certain functions may require additional hardware, different CPU type or additional memory capacity or may cause compatibility issue with other functions. In case of doubt, contact your FANUC sales representative for additional information and support.

The information given in the FANUC manuals or original manufacturer documentation shall prevail. Technical data is subject to change without prior notice. No part of this document may be reproduced in any form. All rights reserved. © FANUC 2017

# 049

## Controlled Axis

# Axis Synchronous Control

## Features

The Axis Synchronous function allows up to 4 master/slave servo motor pairs to perform synchronized motion. This feature is typically used on gantry or split table axes.

This function is a basic function in FANUC Series 0i-F.

## Benefits

- Machining of large work piece
- Each table can also be independently or synchronized controlled during normal operation
- Up to four axis can be synchronously controlled

## Ordering Information

Specification	Description
A02B-0323-J843	30i-B Axis Synchronous Control - Incl. Tandem Control
A02B-0326-J843	31i-B5 Axis Synchronous Control - Incl. Tandem Control
A02B-0327-J843	31i-B Axis Synchronous Control - Incl. Tandem Control
A02B-0328-J843	32i-B Axis Synchronous Control - Incl. Tandem Control
A02B-0333-J843	35i-B Axis Synchronous Control (Max. 8 Axis Pairs) - Incl. Tandem Control
A02B-0334-J843	PM i-A Axis Synchronous Control - Incl. Tandem Control (max. 16 Axis Pairs)

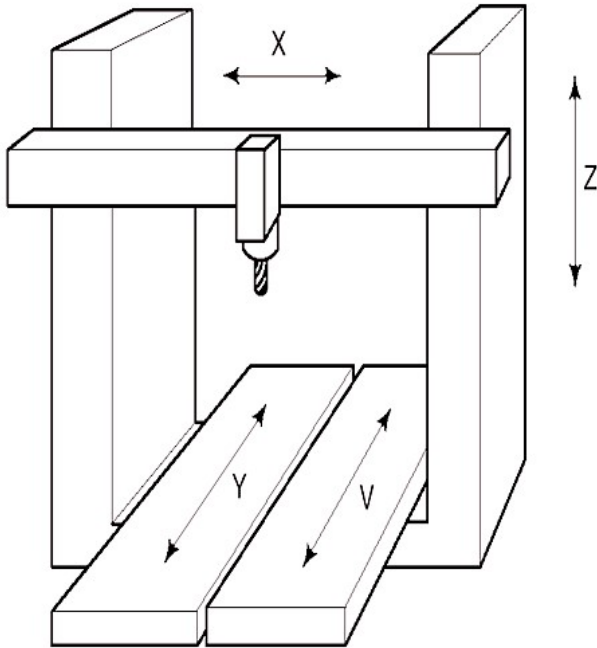

### Notice

Certain functions may require additional hardware, different CPU type or additional memory capacity or may cause compatibility issue with other functions. In case of doubt, contact your FANUC sales representative for additional information and support.

The information given in the FANUC manuals or original manufacturer documentation shall prevail. Technical data is subject to change without prior notice. No part of this document may be reproduced in any form. All rights reserved. © FANUC 2017

# 050

## Controlled Axis

# Twin Table Control

---

## Features

The Twin Table Control function allows two specified axes to be switched between synchronous, independent, or normal operation, using the appropriate switches on the machine operator's panel.

## Benefits

- Flexible operation selection
- Increase of machine efficiency and productivity
- Speed up programming and CNC commissioning

## Ordering Information

Specification	Description
A02B-0323-J698	30i-B Twin Table Control
A02B-0326-J698	31i-B5 Twin Table Control
A02B-0327-J698	31i-B Twin Table Control
A02B-0328-J698	32i-B Twin Table Control
A02B-0340-J698	0i-MF Twin Table Control

### Notice

Certain functions may require additional hardware, different CPU type or additional memory capacity or may cause compatibility issue with other functions. In case of doubt, contact your FANUC sales representative for additional information and support.

The information given in the FANUC manuals or original manufacturer documentation shall prevail. Technical data is subject to change without prior notice. No part of this document may be reproduced in any form. All rights reserved. © FANUC 2017

# 051

## Controlled Axis

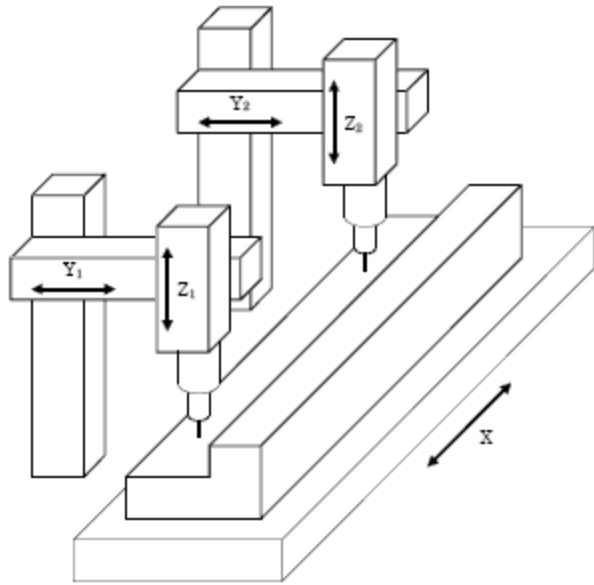

### Notice

Certain functions may require additional hardware, different CPU type or additional memory capacity or may cause compatibility issue with other functions. In case of doubt, contact your FANUC sales representative for additional information and support.

The information given in the FANUC manuals or original manufacturer documentation shall prevail. Technical data is subject to change without prior notice. No part of this document may be reproduced in any form. All rights reserved. © FANUC 2017

# Parallel Axis Control

## Features

When a machine tool is featuring multiple heads and multiple tables, machining multiple workpieces with the same shape at the same time on these multiple tables, multiple controlled axes having the same axis name can be operated at the same time by the use of a move command that specifies only one program axis.

This operation is called parallel operation. Two or more axes which operate in parallel at the same time upon the execution of a command that specifies only one program axis are called parallel axes.

The Parallel Axis Control function is effective in MEM mode, MDI mode, and manual numeric commands in machining center with one path. In manual operation, the parallel function can not be used. Each controlled axis operates independently.

In parallel operation, controlled axes related to one program axis operate in the same way. With the use of an input signal sent from the machine side, only the specified axis is selected among multiple parallel axes and operated (parking).

## Notes:

Parallel axis control function is limited to machining center with one path only.

Parallel axis control function does not support the following motion functions:

- Smooth interpolation
- Nano smoothing
- 3-dimensional coordinate system conversion
- 3-dimensional tool compensation
- Tool length compensation in tool axis direction
- Tool center point control
- Tool posture control
- 3-dimensional cutter compensation
- Tilted working plane indexing
- Nano smoothing 2
- Workpiece setting error compensation
- Tandem control
- Feed axis synchronization control
- Twin table control
- Synchronous / Composite control
- Superimposed Control

## Benefits

- Simple and effective implementation of machines performing parallel machining or multiple boring / drilling stations
- Increase machine efficiency and productivity
- Simplified programming of the machining cycles
- Speeds up CNC and machine commissioning

## Ordering Information

Specification	Description
A02B-0323-R509	30i-B Parallel Axis Control
A02B-0326-R509	31i-B5 Parallel Axis Control
A02B-0327-R509	31i-B Parallel Axis Control

### Notice

Certain functions may require additional hardware, different CPU type or additional memory capacity or may cause compatibility issue with other functions. In case of doubt, contact your FANUC sales representative for additional information and support.

The information given in the FANUC manuals or original manufacturer documentation shall prevail. Technical data is subject to change without prior notice. No part of this document may be reproduced in any form. All rights reserved. © FANUC 2017

# 053

## Controlled Axis

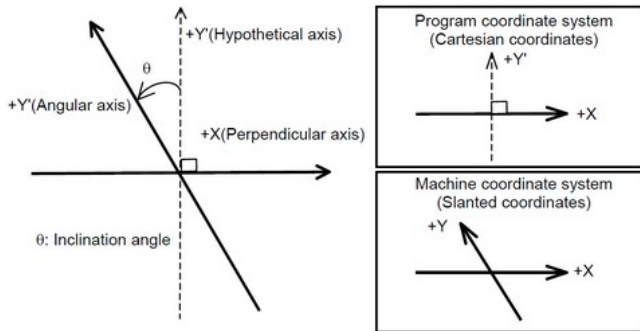

# Arbitrary Angular Axis Control

## Features

When the angular axis installed makes an angle other than  $90^\circ$  with the perpendicular axis, the angular axis control function can control the distance traveled along each axis according to the inclination angle, as if the angular axis makes an angle of  $90^\circ$  with the perpendicular axis.

Arbitrary axes can be specified as a set of an angular axis and perpendicular axis by parameter setting. The actual distance traveled is controlled according to an inclination angle. However, a program, when created, assumes that the angular axis and perpendicular axis intersect at right angles.

## Benefits

- Increase machine efficiency and productivity
- Simplified programming of the machining cycles
- Speeds up CNC and machine commissioning

## Ordering Information

Specification	Description
A02B-0323-J924	30i-B Arbitrary Angular Axis Control
A02B-0326-J924	31i-B5 Arbitrary Angular Axis Control
A02B-0327-J924	31i-B Arbitrary Angular Axis Control
A02B-0328-J924	32i-B Arbitrary Angular Axis Control
A02B-0339-J924	0i-TF Angular Axis Control
A02B-0340-J924	0i-MF Angular Axis Control

### Notice

Certain functions may require additional hardware, different CPU type or additional memory capacity or may cause compatibility issue with other functions. In case of doubt, contact your FANUC sales representative for additional information and support.

The information given in the FANUC manuals or original manufacturer documentation shall prevail. Technical data is subject to change without prior notice. No part of this document may be reproduced in any form. All rights reserved. © FANUC 2017

# 054

## Controlled Axis

# Inclined Rotary Axis Control

## Features

The Inclined Rotary Axis Control function provides the following 5-axes control capabilities:

- Tilted Working Plane Command (TWP)
- Tool Center Point Control (TCP)
- 3-Dimensional Cutter/Radius Compensation
- 3-Dimensional Manual Feed

This function can be used on machines where the tool rotation axis or the table rotation axis is inclined with respect to the X-Y plane, a Y-Z plane or a Z-X plane of the machine coordinate system.

## Benefits

- Supports 5-Axes functions on machines with non-orthogonal primary linear axes

## Ordering Information

Specification	Description
A02B-0323-S688	30i-B Inclined Rotary Axis Control
A02B-0326-S688	31i-B5 Inclined Rotary Axis Control
A02B-0327-S688	31i-B Inclined Rotary Axis Control
A02B-0328-S688	32i-B Inclined Rotary Axis Control
A02B-0340-S688	0i-MF Inclined Rotary Axis Control

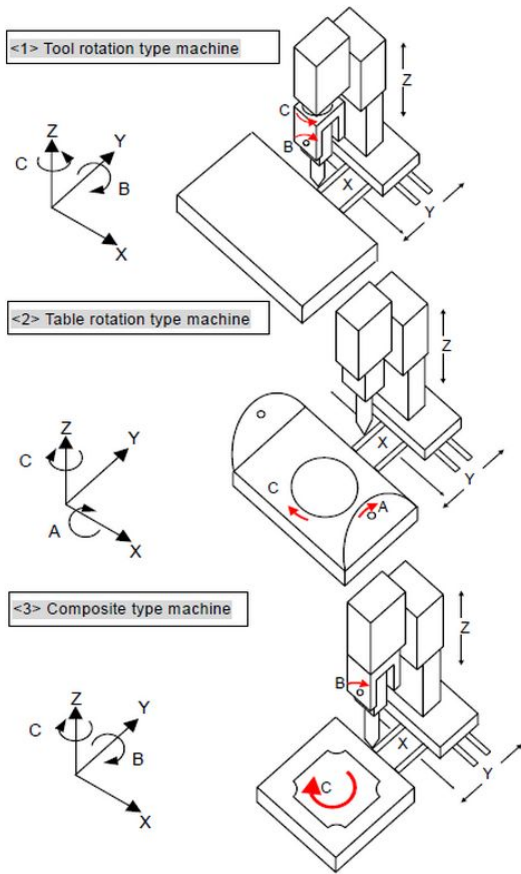

### Notice

Certain functions may require additional hardware, different CPU type or additional memory capacity or may cause compatibility issue with other functions. In case of doubt, contact your FANUC sales representative for additional information and support.

The information given in the FANUC manuals or original manufacturer documentation shall prevail. Technical data is subject to change without prior notice. No part of this document may be reproduced in any form. All rights reserved. © FANUC 2017

# 055

## Controlled Axis

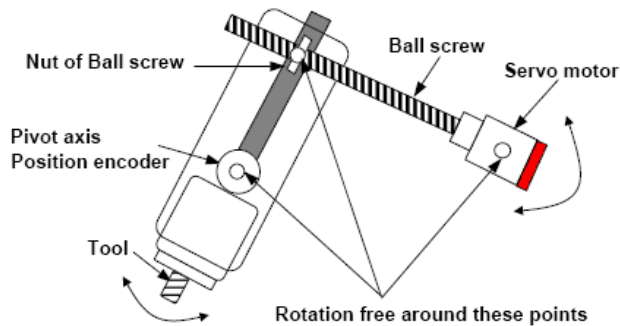

## Pivot Axis Control

### Features

The Pivot Axis Control function allows to control a pivot axis (B-axis) by a ball screw connected to a servo motor, which direction is free.

Generally, the relation between the rotating angle of motor and the position of rotation axis on the machine is proportional. When using this function, the rotation angle of the motor is not proportional to the rotation angle of the pivot axis (B-axis) on the machine.

The position command is output to drive the servo motor, and the position encoder is mounted to follow the rotation angle of pivot axis (B-axis). The speed of pivot axis (B-axis) may fluctuate; to decrease the fluctuation and keep the actual position gain constant, the function changes the position gain of the motor according to the position of pivot axis (B-axis).

### Benefits

- Simple and effective implementation of complex pivotal systems
- Increase machine efficiency and productivity
- Simplified programming of the machining cycles
- Speeds up CNC and machine commissioning

### Ordering Information

Specification	Description
A02B-0323-S665	30i-B Pivot Axis Control
A02B-0326-S665	31i-B5 Pivot Axis Control
A02B-0327-S665	31i-B Pivot Axis Control

#### Notice

Certain functions may require additional hardware, different CPU type or additional memory capacity or may cause compatibility issue with other functions. In case of doubt, contact your FANUC sales representative for additional information and support.

The information given in the FANUC manuals or original manufacturer documentation shall prevail. Technical data is subject to change without prior notice. No part of this document may be reproduced in any form. All rights reserved. © FANUC 2017



# 056

## Controlled Axis

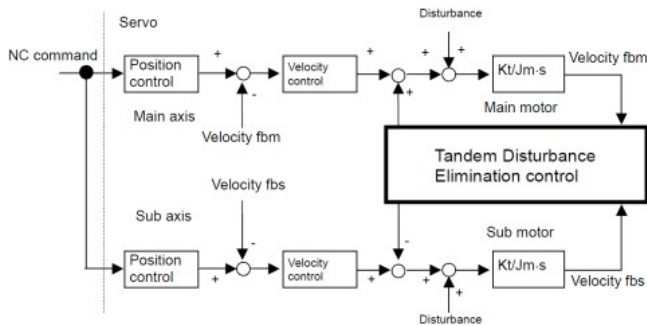

# Tandem Disturbance Elimination Function

## Features

This function suppresses vibration caused by interferences between the main axis and the sub-axis in a position tandem control (feed axis synchronization).

## Note

The axis synchronous control function is required.

## Benefits

- Simple and effective implementation of vibration suppression on a tandem machine
- Increase machining quality, efficiency and productivity

## Ordering Information

Specification	Description
A02B-0323-S660	30i-B Tandem Disturbance Elimination Control
A02B-0326-S660	31i-B5 Tandem Disturbance Elimination Control
A02B-0327-S660	31i-B Tandem Disturbance Elimination Control
A02B-0328-S660	32i-B Tandem Disturbance Elimination Control
A02B-0333-S660	35i-B Tandem Disturbance Elimination Control
A02B-0334-S660	PM i-A Tandem Disturbance Elimination Control
A02B-0339-S660	0i-TF Tandem Disturbance Elimination Control
A02B-0340-S660	0i-MF Tandem Disturbance EliminationControl

### Notice

Certain functions may require additional hardware, different CPU type or additional memory capacity or may cause compatibility issue with other functions. In case of doubt, contact your FANUC sales representative for additional information and support.

The information given in the FANUC manuals or original manufacturer documentation shall prevail. Technical data is subject to change without prior notice. No part of this document may be reproduced in any form. All rights reserved. © FANUC 2017

# 057

## Controlled Axis

# Pole Position Detection Function

## Features

When FANUC DiS (torque) motors, FANUC LiS (linear) motors or 3rd party motors are driven by a FANUC servo system, the Pole Position Detection function allows the proper detection of the position of magnetic poles.

## Notes

- This function cannot be used with a vertical axis to which force is applied at all times
- This function cannot be used with an axis when the axis is completely locked

## Benefits

- Detection of magnetic poles of FANUC DiS (torque) and LiS (linear) servo motors
- Detection of magnetic poles of 3rd party servo motors with a FANUC servo amplifier system
- Speeds up CNC and machine commissioning

## Ordering Information

Specification	Description
A02B-0323-S744	30i-B Pole Position Detection Function
A02B-0326-S744	31i-B5 Pole Position Detection Function
A02B-0327-S744	31i-B Pole Position Detection Function
A02B-0328-S744	32i-B Pole Position Detection Function
A02B-0333-S744	35i-B Pole Position Detection Function
A02B-0334-S744	PM i-A Pole Position Detection Function
A02B-0339-S744	0i-TF Pole Position Detection Function
A02B-0340-S744	0i-MF Pole Position Detection Function

### Notice

Certain functions may require additional hardware, different CPU type or additional memory capacity or may cause compatibility issue with other functions. In case of doubt, contact your FANUC sales representative for additional information and support.

The information given in the FANUC manuals or original manufacturer documentation shall prevail. Technical data is subject to change without prior notice. No part of this document may be reproduced in any form. All rights reserved. © FANUC 2017

# 058

## Controlled Axis

# Controlled Axes Detach

## Features

With the Controlled Axes Detach function, an entire axis, including servo motor and feedback, can be "detached" or disabled from the machine and the control system without creating any alarm.

This function is a basic function in FANUC Series 0i-F.

## Benefits

- Typically used for fourth axis such as rotary table, right angle head
- Easy to implement a plug and play solution without operator intervention with the machine controller
- Position display shows the attached axis positions
- Easy to use for production adaptability and flexibility

## Ordering Information

Specification	Description
A02B-0323-J807	30i-B Axes Detach
A02B-0326-J807	31i-B5 Axes Detach
A02B-0327-J807	31i-B Axes Detach
A02B-0328-J807	32i-B Axes Detach

### Notice

Certain functions may require additional hardware, different CPU type or additional memory capacity or may cause compatibility issue with other functions. In case of doubt, contact your FANUC sales representative for additional information and support.

The information given in the FANUC manuals or original manufacturer documentation shall prevail. Technical data is subject to change without prior notice. No part of this document may be reproduced in any form. All rights reserved. © FANUC 2017

# 059

## Controlled Axis

# Dual Control Axes Switching

## Features

With the Dual Control Axes Switching function, it is possible to allocate two control axes to one motor. When the two allocated control axes are in controlled axes detach, the axes can be switched. As a result, one motor can have two independent axes settings such as parameters, compensation, and custom macro system variables.

## Note

Dual Control Axes Switching cannot be used together with Dual Check Safety.

This function includes the Controlled Axes Detach function.

## Benefits

- Use attachments with e.g. different gear ratios by one motor

## Ordering Information

Specification	Description
A02B-0326-R390	31i-B5 Dual Control Axes Switching

### Notice

Certain functions may require additional hardware, different CPU type or additional memory capacity or may cause compatibility issue with other functions. In case of doubt, contact your FANUC sales representative for additional information and support.

The information given in the FANUC manuals or original manufacturer documentation shall prevail. Technical data is subject to change without prior notice. No part of this document may be reproduced in any form. All rights reserved. © FANUC 2017

# 060

## Controlled Axis

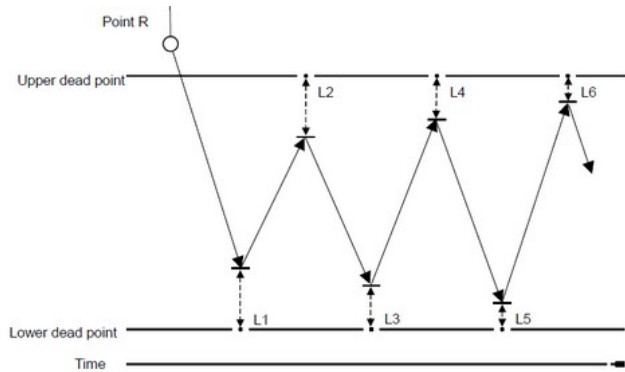

## Chopping

### Features

The Chopping function controls an up and down motion for side face grinding while servo delay compensation is used to minimize errors at upper and lower dead points (end points).

A chopping cycle is activated by the G81.1 command or a PMC signal; a G80 command cancels this chopping cycle. Parameters are used to specify the movement itself.

### Benefits

- Allows complex gear cutting/grinding operations
- Simplifies programming

### Ordering Information

Specification	Description
A02B-0323-J707	30i-B Chopping Function
A02B-0326-J707	31i-B5 Chopping Function
A02B-0327-J707	31i-B Chopping Function
A02B-0328-J707	32i-B Chopping Function

### Notice

Certain functions may require additional hardware, different CPU type or additional memory capacity or may cause compatibility issue with other functions. In case of doubt, contact your FANUC sales representative for additional information and support.

The information given in the FANUC manuals or original manufacturer documentation shall prevail. Technical data is subject to change without prior notice. No part of this document may be reproduced in any form. All rights reserved. © FANUC 2017

# 061

## Controlled Axis

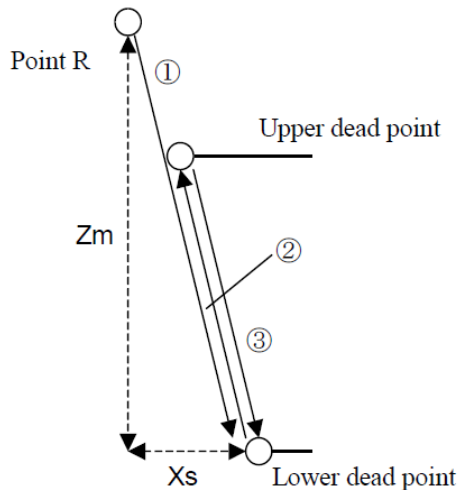

Movement process :

(1): Movement from point R to lower dead point

(2): Movement from lower dead point to upper dead point

(3): Movement from upper dead point to lower dead point

After (1), repeat (2) and (3).

### Notice

Certain functions may require additional hardware, different CPU type or additional memory capacity or may cause compatibility issue with other functions. In case of doubt, contact your FANUC sales representative for additional information and support.

The information given in the FANUC manuals or original manufacturer documentation shall prevail. Technical data is subject to change without prior notice. No part of this document may be reproduced in any form. All rights reserved. © FANUC 2017

# Chopping Function by Flexible Synchronization Control

## Features

The Chopping Function by Flexible Synchronization Control allows to use the chopping function together with the flexible synchronization control. This enables chopping on two axes simultaneously. It is possible to synchronize an axis with a chopping axis.

This function enables to override the commanded gear ratio of the flexible synchronization control. The actual gear ratio is obtained by multiplying the commanded gear ratio with an override signal. The range of the override signal is 0% to 254%.

## Note

The options Flexible Synchronization Control and Chopping are not necessary to use this option. This function cannot be specified for Lathe systems.

## Benefits

- Expands the application range of the chopping function
- Suitable for processing inclined surfaces with a grinder

## Ordering Information

Specification	Description
A02B-0323-R547	30i-B Chopping Function by Flexible Synchronous Control
A02B-0326-R547	31i-B5 Chopping Function by Flexible Synchronous Control
A02B-0327-R547	31i-B Chopping Function by Flexible Synchronous Control
A02B-0328-R547	32i-B Chopping Function by Flexible Synchronous Control

# 062

## Controlled Axis

CHOPPING DATA	
(SETTING DATA)	
R1(START) POINT	= 110.0000
UPPER DEAD POINT	= 100.0000
LOWER DEAD POINT	= 75.0000
CHOPPING FEED RATE	= 1000.0000
CHOPPING AXIS	= 1
R-APPROACH RATE	= 1000.0000
R2(END) POINT	= 115.0000
HOME POINT	= 120.0000
TOGGLE HOME FEED RATE	= 1000.0000

### Notice

Certain functions may require additional hardware, different CPU type or additional memory capacity or may cause compatibility issue with other functions. In case of doubt, contact your FANUC sales representative for additional information and support.

The information given in the FANUC manuals or original manufacturer documentation shall prevail. Technical data is subject to change without prior notice. No part of this document may be reproduced in any form. All rights reserved. © FANUC 2017

## Chopping Setting Screen

### Features

The Chopping Setting Screen extends the chopping function with additional features:

- Various chopping parameters can be set by the chopping setting screen.
- The feedrate from the start point to the chopping reference point (approach rate) can be set independently.
- The moving direction of the chopping axis can be changed during the chopping operation by direction change signals.
- The end position of the chopping axis (R2 point) can be set independently.
- An additional servo delay compensation method is added, where the chopping feedrate is not changed.
- Chopping data such as stroke count etc. can be queried by the PMC.

The Chopping function or the Chopping Function by Flexible Synchronization Control is required to use this function.

### Benefits

- Simplifies the operation of the chopping function
- Expands application range of the chopping function

### Ordering Information

Specification	Description
A02B-0323-R614	30i-B Chopping Setting Screen
A02B-0326-R614	31i-B5 Chopping Setting Screen
A02B-0327-R614	31i-B Chopping Setting Screen
A02B-0328-R614	32i-B Chopping Setting Screen

# 063

## Controlled Axis

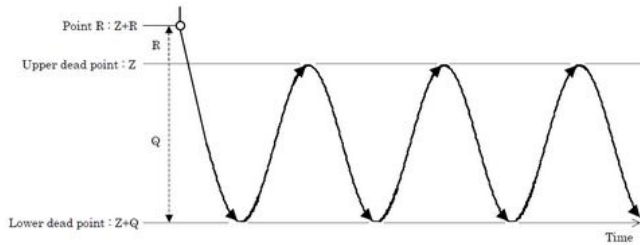

# High-Precision Oscillation Function

## Features

In this function, the feedrate of an oscillation axis (equivalent to a chopping axis that is moved vertically and repeatedly for grinding) changes along a sine curve.

This function is effective to improve the accuracy of movement between upper dead point and lower dead point.

In addition, the look-ahead feed forward function can be used with oscillation motion; in this case a higher accuracy can be achieved even if the oscillation feedrate or the upper or lower dead point are changed.

## Benefits

- Simplification of the programming
- Increase of the precision and productivity of the machine

## Ordering Information

Specification	Description
A02B-0323-R662	30i-B High Precision Oscillation Function
A02B-0326-R662	31i-B5 High Precision Oscillation Function
A02B-0327-R662	31i-B High Precision Oscillation Function
A02B-0328-R662	32i-B High Precision Oscillation Function
A02B-0339-R662	0i-TF High Precision Oscillation Function
A02B-0340-R662	0i-MF High Precision Oscillation Function

### Notice

Certain functions may require additional hardware, different CPU type or additional memory capacity or may cause compatibility issue with other functions. In case of doubt, contact your FANUC sales representative for additional information and support.

The information given in the FANUC manuals or original manufacturer documentation shall prevail. Technical data is subject to change without prior notice. No part of this document may be reproduced in any form. All rights reserved. © FANUC 2017



# 064

## Controlled Axis

# PMC Axis Control - Acceleration/Deceleration Specification Feed

---

## Features

The PMC Axis Control - Acceleration/Deceleration Specification Feed function allows to specify the acceleration and the deceleration of an PMC-controlled axis motion independently.

The Axis Control by PMC function is necessary to use this function.

## Benefits

- Extends the application range of the Axis Control by PMC function

## Ordering Information

Specification	Description
A02B-0323-R640	30i-B PMC Axis Control - Acceleration/Deceleration Specification Feed
A02B-0326-R640	31i-B5 PMC Axis Control - Acceleration/Deceleration Specification Feed
A02B-0327-R640	31i-B PMC Axis Control - Acceleration/Deceleration Specification Feed
A02B-0328-R640	32i-B PMC Axis Control - Acceleration/Deceleration Specification Feed
A02B-0333-R640	35i-B PMC Axis Control - Acceleration/Deceleration Specification Feed
A02B-0334-R640	PM i-A PMC Axis Control - Acceleration/Deceleration Specification Feed
A02B-0339-R640	0i-TF PMC Axis Control - Acceleration/Deceleration Specification Feed
A02B-0340-R640	0i-MF PMC Axis Control - Acceleration/Deceleration Specification Feed

### Notice

Certain functions may require additional hardware, different CPU type or additional memory capacity or may cause compatibility issue with other functions. In case of doubt, contact your FANUC sales representative for additional information and support.

The information given in the FANUC manuals or original manufacturer documentation shall prevail. Technical data is subject to change without prior notice. No part of this document may be reproduced in any form. All rights reserved. © FANUC 2017

# 065

## Controlled Axis

# Increment System C

---

The Increment System C allows programming to 0.0001mm or 0.00001 inches or 0.0001 degrees.

This function is a basic function in FANUC Series 0i-F.

## Ordering Information

Specification	Description
A02B-0323-J805	30i-B Increment System C
A02B-0326-J805	31i-B5 Increment System C
A02B-0327-J805	31i-B Increment System C
A02B-0328-J805	32i-B Increment System C

### Notice

Certain functions may require additional hardware, different CPU type or additional memory capacity or may cause compatibility issue with other functions. In case of doubt, contact your FANUC sales representative for additional information and support.

The information given in the FANUC manuals or original manufacturer documentation shall prevail. Technical data is subject to change without prior notice. No part of this document may be reproduced in any form. All rights reserved. © FANUC 2017

# 066

## Controlled Axis

# Increment System D

The Increment System D allows programming to 0.00001mm or 0.000001 inches or 0.00001 degrees.

## Ordering Information

Specification	Description
A02B-0323-S694	30i-B Increment System D
A02B-0326-S694	31i-B5 Increment System D
A02B-0327-S694	31i-B Increment System D
A02B-0328-S694	32i-B Increment System D

### Notice

Certain functions may require additional hardware, different CPU type or additional memory capacity or may cause compatibility issue with other functions. In case of doubt, contact your FANUC sales representative for additional information and support.

The information given in the FANUC manuals or original manufacturer documentation shall prevail. Technical data is subject to change without prior notice. No part of this document may be reproduced in any form. All rights reserved. © FANUC 2017

# 067

## Controlled Axis

# Increment System E

---

The Increment System E allows programming to 0.000001mm or 0.0000001 inches or 0.000001 degrees.

## Ordering Information

Specification	Description
A02B-0323-S805	30i-B Increment System E
A02B-0326-S805	31i-B5 Increment System E
A02B-0327-S805	31i-B Increment System E

### Notice

Certain functions may require additional hardware, different CPU type or additional memory capacity or may cause compatibility issue with other functions. In case of doubt, contact your FANUC sales representative for additional information and support.

The information given in the FANUC manuals or original manufacturer documentation shall prevail. Technical data is subject to change without prior notice. No part of this document may be reproduced in any form. All rights reserved. © FANUC 2017

# 068

## Controlled Axis

# Arbitrary Command Multiply

## Features

The Arbitrary Command Multiply function provides the flexibility to set the gearing between the position feedback device and the motor for a given axis.

When the detection unit assumes a special value, an arbitrary command multiply can be set using a ratio of n:m. The setting range is 1/9999 to 9999/1.

## Benefits

- Increase of the flexibility and adaptation of the CNC to the machine structure
- Speeds up CNC and machine design and commissioning

## Ordering Information

Specification	Description
A02B-0323-S806	30i-B Arbitrary Command Multiply
A02B-0326-S806	31i-B5 Arbitrary Command Multiply
A02B-0327-S806	31i-B Arbitrary Command Multiply
A02B-0328-S806	32i-B Arbitrary Command Multiply

### Notice

Certain functions may require additional hardware, different CPU type or additional memory capacity or may cause compatibility issue with other functions. In case of doubt, contact your FANUC sales representative for additional information and support.

The information given in the FANUC manuals or original manufacturer documentation shall prevail. Technical data is subject to change without prior notice. No part of this document may be reproduced in any form. All rights reserved. © FANUC 2017

# 069

## Controlled Axis

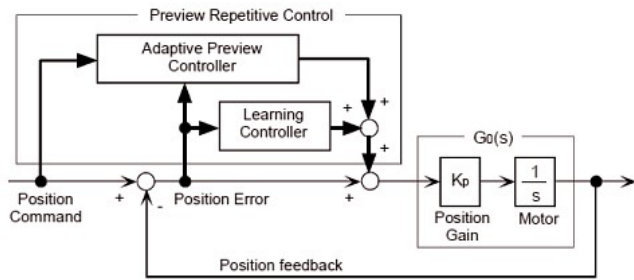

# High-Precision Learning Control A

## Features

The High-Precision Learning Control A function (formerly Preview Repetitive Control) is a function designed to allow high-speed and high-precision cutting by recovering previously saved cutting data from memory and utilizing that data during production for optimization purpose.

High-Precision Learning Control A, is used to increase the speed and accuracy of machining high volume parts.

Before employing this function in production, the axes involved in the prescribed machining operation must first be “taught” the desired path movements and related cutting data. This data is stored in memory and recovered for use as a template during production.

Compared to High-Precision Learning Control B (formerly Learning Control), this function reduces also the Following Error of the first cycle while using advanced previewing functionality of the control.

This function is ideal for camshaft grinding, crankshaft pin grinding, piston lathes or aspherical lens cutting applications.

## Benefits

- Increased speed and accuracy when machining high volume parts
- Higher accuracy than the High-Precision Learning Control B function as it reduces the position error much faster
- Replaces an expensive mechanical cam with an electronic template that causes the axes to follow a virtual cam

## Ordering Information

Specification	Description
A02B-0323-J706	30i-B High-Precision Learning Control A - Incl. Spindle Learning Control
A02B-0326-J706	31i-B5 High-Precision Learning Control A - Incl. Spindle Learning Control
A02B-0327-J706	31i-B High-Precision Learning Control A - Incl. Spindle Learning Control

### Notice

Certain functions may require additional hardware, different CPU type or additional memory capacity or may cause compatibility issue with other functions. In case of doubt, contact your FANUC sales representative for additional information and support.

The information given in the FANUC manuals or original manufacturer documentation shall prevail. Technical data is subject to change without prior notice. No part of this document may be reproduced in any form. All rights reserved. © FANUC 2017

# 070

## Controlled Axis

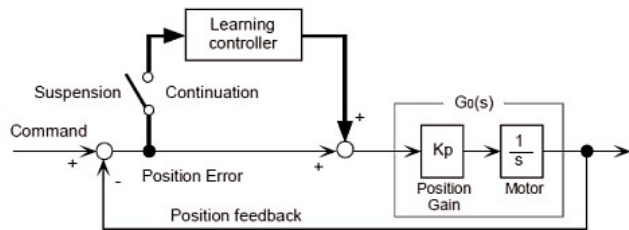

## High-Precision Learning Control B

### Features

The High-Precision Learning Control B function (formerly Learning Control) is a function designed to allow high-speed and high-precision cutting by recovering previously saved cutting data from memory and utilizing that data during production. The CNC works to eliminate the position error in the live cutting path versus the memorized data.

Before employing this function in production, the axes involved in the prescribed machining operation must first be “taught” the desired path movements and related cutting data. These are then stored in memory and recovered for use as a template during production.

Compared to the High-Precision Learning Function A, the High-Precision Learning Function B does not feature the Advanced Preview Control

This function is ideal for camshaft grinding, crankshaft pin grinding, piston lathes or aspherical lens cutting applications.

### Benefits

- Learning Control is used to increase the speed and accuracy of machining high volume parts.
- Replace an expensive mechanical cam with an electronic template that causes the axes to follow a virtual cam.

### Ordering Information

Specification	Description
A02B-0323-J705	30i-B High-Precision Learning Control B - Incl. Spindle Learning Control
A02B-0326-J705	31i-B5 High-Precision Learning Control B - Incl. Spindle Learning Control
A02B-0327-J705	31i-B High-Precision Learning Control B - Incl. Spindle Learning Control

#### Notice

Certain functions may require additional hardware, different CPU type or additional memory capacity or may cause compatibility issue with other functions. In case of doubt, contact your FANUC sales representative for additional information and support.

The information given in the FANUC manuals or original manufacturer documentation shall prevail. Technical data is subject to change without prior notice. No part of this document may be reproduced in any form. All rights reserved. © FANUC 2017

# 071

## Controlled Axis

# High-Precision Learning Control C

## Features

The High-Precision Learning Control C function (formerly Compact Learning Control) is a subset function of the High-Precision Learning Control B. It can be implemented on standard servo axis cards instead of the servo axes card with large memory (L24 servo cards).

This function provides an angle-base learning control for compact application without handling learning data.

The High-Precision Learning Control C function can be used for applications such as gear grinding, gear cutting and shaping as well as to control grinder oscillation.

## Benefits

- Learning Control increases the speed and accuracy of the machining when producing parts in high volume.

## Ordering Information

Specification	Description
A02B-0323-R692	30i-B High-Precision Learning Control C
A02B-0326-R692	31i-B5 High-Precision Learning Control C
A02B-0327-R692	31i-B High-Precision Learning Control C

### Notice

Certain functions may require additional hardware, different CPU type or additional memory capacity or may cause compatibility issue with other functions. In case of doubt, contact your FANUC sales representative for additional information and support.

The information given in the FANUC manuals or original manufacturer documentation shall prevail. Technical data is subject to change without prior notice. No part of this document may be reproduced in any form. All rights reserved. © FANUC 2017



# 072

## Controlled Axis

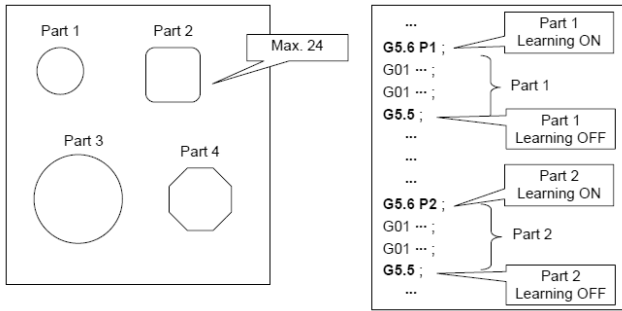

# Learning Control for Parts Cutting A

## Features

The Learning Control for Parts Cutting A function (formerly Learning Control for Parts Cutting) can achieve high precision machining when producing many items with an identical profile.

While machining such an item, there may be multiple identical operations that may be applied to each work-piece in succession. Each repeated path element (such as a drilling sequence or a pocketing sequence) may be treated as a path element to which Learning Control for Parts Cutting may be applied.

## Benefits

- Allows the programmer to apply high-precision cutting to specified path elements within the part program.

## Ordering Information

Specification	Description
A02B-0323-R510	30i-B Learning Control for Parts Cutting A
A02B-0326-R510	31i-B5 Learning Control for Parts Cutting A
A02B-0327-R510	31i-B Learning Control for Parts Cutting A
A02B-0328-R510	32i-B Learning Control for Parts Cutting A

### Notice

Certain functions may require additional hardware, different CPU type or additional memory capacity or may cause compatibility issue with other functions. In case of doubt, contact your FANUC sales representative for additional information and support.

The information given in the FANUC manuals or original manufacturer documentation shall prevail. Technical data is subject to change without prior notice. No part of this document may be reproduced in any form. All rights reserved. © FANUC 2017

# 073

## Controlled Axis

# Learning Control for Parts Cutting B

## Features

The Learning Control for Parts Cutting B function (formerly Learning Control for Rigid Tapping) provides a superior controllability in repetitive command for rigid-tapping operation.

It features capabilities to realize high-speed and high-precision machining sequences by minimizing the synchronous error between spindle and tap feed axis during Rigid Tapping.

## Benefits

- Synchronous error between the spindle axis and the z-axis learned at the z-axis to minimize synchronous error, which enables the z-axis to follow the spindle axis completely, and produces higher precision in machining
- Does not require any special format programs. The only commands that have to be added to the rigid tapping program are Learning On (G5.6 P\_ Q1) and Learning Off (G5.5 Q1)
- Uses standard servo cards for up to 24 types of tapping in a total of 16 seconds
- Maintains high precision while improving machining speed or reducing acceleration and deceleration time constant
- Most effective control to improve rigid tap precision and reduce cycle time

## Ordering Information

Specification	Description
A02B-0323-R539	30i-B Learning Control for Parts Cutting B [Needs Rigid Tapping]
A02B-0326-R539	31i-B5 Learning Control for Parts Cutting B [Needs Rigid Tapping]
A02B-0327-R539	31i-B Learning Control for Parts Cutting B [Needs Rigid Tapping]
A02B-0328-R539	32i-B Learning Control for Parts Cutting B [Needs Rigid Tapping]

Learning Control for Rigid Tapping

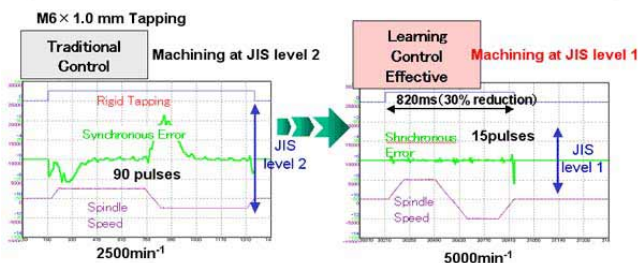
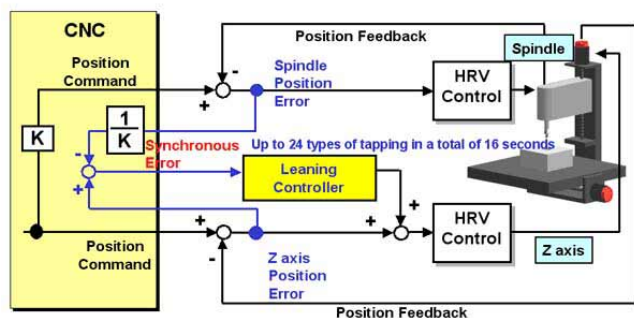

### Notice

Certain functions may require additional hardware, different CPU type or additional memory capacity or may cause compatibility issue with other functions. In case of doubt, contact your FANUC sales representative for additional information and support.

The information given in the FANUC manuals or original manufacturer documentation shall prevail. Technical data is subject to change without prior notice. No part of this document may be reproduced in any form. All rights reserved. © FANUC 2017

# 074

## Controlled Axis

# Spindle Learning Control

## Features

The Spindle Learning Control function is used to increase the speed and accuracy of machining high volume parts.

This function works like the servo-based Learning Control, except that the spindle control loop applies to the compensation mechanism instead of the servo control loop.

## Notes

- A special software is required in the spindle amplifier
- The Cs Contouring Control function is required in the CNC

## Benefits

- Increase the speed and accuracy of machining high volume parts

## Ordering Information

Specification	Description
A02B-0323-S635	30i-B Spindle Learning Control
A02B-0326-S635	31i-B5 Spindle Learning Control
A02B-0327-S635	31i-B Spindle Learning Control

### Notice

Certain functions may require additional hardware, different CPU type or additional memory capacity or may cause compatibility issue with other functions. In case of doubt, contact your FANUC sales representative for additional information and support.

The information given in the FANUC manuals or original manufacturer documentation shall prevail. Technical data is subject to change without prior notice. No part of this document may be reproduced in any form. All rights reserved. © FANUC 2017

# 075

## Controlled Axis

# Spindle Learning Control in High-Precision Learning Control A/B

---

## Features

The Spindle Learning Control in High-Precision Learning Control function is used to increase the speed and accuracy of machining high volume parts.

This function works like the servo-based Learning Control, except that the spindle control loop applies to the compensation mechanism instead of the servo control loop.

This function is applicable if Spindle Learning Control is used together with High-Precision Learning Control A or B.

## Notes

- A special software is required in the spindle amplifier
- The Cs Contouring Control function is required in the CNC

## Benefits

- Increase the speed and accuracy of machining high volume parts

## Ordering Information

Specification	Description
A02B-0323-J386	30i-B Spindle Learning Control in High Precision Learning Control A or B

### Notice

Certain functions may require additional hardware, different CPU type or additional memory capacity or may cause compatibility issue with other functions. In case of doubt, contact your FANUC sales representative for additional information and support.

The information given in the FANUC manuals or original manufacturer documentation shall prevail. Technical data is subject to change without prior notice. No part of this document may be reproduced in any form. All rights reserved. © FANUC 2017

# 076

## Controlled Axis

# Learning Control - Memory Expansion

## Features

When using the High-Precision Learning Control function on the CNC, this function expands the maximum number of available profiles and learning steps.

	Max. number of profiles	Max. number of learning steps
Standard	5	2
With this function	24	5

## Benefits

- Increased Learning Memory for complex profiles or where a long learning period is required

## Ordering Information

Specification	Description
A02B-0323-J976	30i-B Memory Expansion for Learning Control
A02B-0326-J976	31i-B5 Memory Expansion for Learning Control
A02B-0327-J976	31i-B Memory Expansion for Learning Control

### Notice

Certain functions may require additional hardware, different CPU type or additional memory capacity or may cause compatibility issue with other functions. In case of doubt, contact your FANUC sales representative for additional information and support.

The information given in the FANUC manuals or original manufacturer documentation shall prevail. Technical data is subject to change without prior notice. No part of this document may be reproduced in any form. All rights reserved. © FANUC 2017

# 077

## Controlled Axis

# Learning Memory Size 10Mbyte

## Features

The standard learning memory for the High-Precision Learning Control of the Series 30i-31i-MODEL B and the Learning Control for Parts Cutting of the Series 30i/31i/32i-MODEL B can be expanded from 5 Mbyte to 10Mbyte.

## Benefits

- Expansion of the learning time or the combination learning time vs. number of learning axes

## Ordering Information

Specification	Description
A02B-0323-R720	30i-B Learning Memory Size 10 MB
A02B-0326-R720	31i-B5 Learning Memory Size 10 MB
A02B-0327-R720	31i-B Learning Memory Size 10 MB
A02B-0328-R720	32i-B Learning Memory Size 10 MB

### Notice

Certain functions may require additional hardware, different CPU type or additional memory capacity or may cause compatibility issue with other functions. In case of doubt, contact your FANUC sales representative for additional information and support.

The information given in the FANUC manuals or original manufacturer documentation shall prevail. Technical data is subject to change without prior notice. No part of this document may be reproduced in any form. All rights reserved. © FANUC 2017

# 078

## Controlled Axis

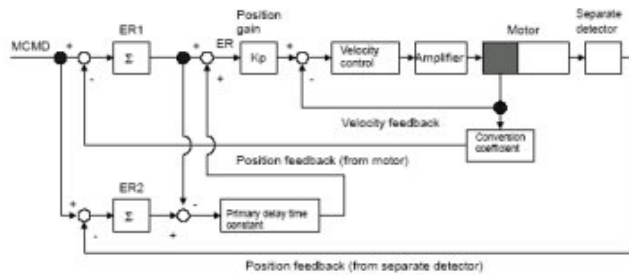

## Dual Position Feedback

### Features

In general, a machine with a large load inertia ratio or with a large backlash may operate stably with a semi-closed loop (motor feedback only) but may vibrate with a closed loop (separate encoder feedback).

The Dual Position Feedback function improves the control in such a way that a machine can operate stably with a closed loop as it would in the case of a semi-closed loop.

### Benefits

- Increase machine stability and precision

### Ordering Information

Specification	Description
A02B-0323-J704	30i-B Dual Position Feedback
A02B-0326-J704	31i-B5 Dual Position Feedback
A02B-0327-J704	31i-B Dual Position Feedback
A02B-0328-J704	32i-B Dual Position Feedback
A02B-0333-J704	35i-B Dual Position Feedback
A02B-0334-J704	PM i-A Dual Position Feedback
A02B-0339-J704	0i-TF Dual Position Feedback
A02B-0340-J704	0i-MF Dual Position Feedback

### Notice

Certain functions may require additional hardware, different CPU type or additional memory capacity or may cause compatibility issue with other functions. In case of doubt, contact your FANUC sales representative for additional information and support.

The information given in the FANUC manuals or original manufacturer documentation shall prevail. Technical data is subject to change without prior notice. No part of this document may be reproduced in any form. All rights reserved. © FANUC 2017

# 079

## Controlled Axis

# Position Feedback Dynamic Switching Function

## Features

The Position Feedback Dynamic Switching function used when a single rotary table with turning capability (hereafter called a rotary table) is controlled by two different operations such as one turning operation and one milling operation.

In case of a turning operation, the rotary table is turned by a spindle motor and a separate position detector.

In case of a milling operation, the rotary table is rotated by a servo motor and a built-in pulse coder.

This function enables the management of the coordinate of the rotary axis even if the position detector is switched. According to the state of control, the position feedback of the rotary axis is dynamically switched between the separate position detector attached with a rotary table and the built-in pulse coder of servo motor using PMC signals.

## Benefits

- Flexible configuration of machines
- Simpler control of advanced mill-turn machine architectures

## Ordering Information

Specification	Description
A02B-0323-S747	30i-B Position Feedback Dynamic Switching
A02B-0326-S747	31i-B5 Position Feedback Dynamic Switching
A02B-0327-S747	31i-B Position Feedback Dynamic Switching
A02B-0328-S747	32i-B Position Feedback Dynamic Switching

### Notice

Certain functions may require additional hardware, different CPU type or additional memory capacity or may cause compatibility issue with other functions. In case of doubt, contact your FANUC sales representative for additional information and support.

The information given in the FANUC manuals or original manufacturer documentation shall prevail. Technical data is subject to change without prior notice. No part of this document may be reproduced in any form. All rights reserved. © FANUC 2017



# 080

## Controlled Axis

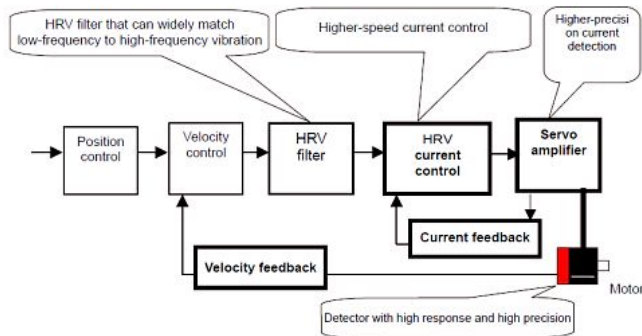

## HRV3 Control

### Features

SERVO HRV control is a digital servo current control methods. When using this method of control, higher speed, higher precision and higher acceleration can be achieved.

There are three types of SERVO HRV control available:

- SERVO HRV2 control
- SERVO HRV3 control
- SERVO HRV4 control

SERVO HRV control has three main features.

1. A disturbance elimination filter which eliminates the low-frequency vibration of a machine with low rigidity
2. Achievement of smooth feed with a high-precision servo amplifiers and detectors
3. The use of high-speed Digital Signal Processor (DSP) which allow a current control period much shorter than the conventional period achieved with standard systems (high-speed HRV current control)

SERVO HRV2 features a current loop of 125  $\mu$ s and is standard on the Series 30i-B CNC.

SERVO HRV3 features a current loop of 62.5  $\mu$ s and is particularly designed for demanding machining applications. It is standard on the Series 0i-F CNC.

SERVO HRV4 features a current loop of 31.25  $\mu$ s and has been designed for specific applications. It also features a faster position loop compared to the HRV2 and HRV3 functions.

### Benefits

- Very performant and scalable axis control

### Ordering Information

Specification	Description
A02B-0323-J398	30i-B High-Speed HRV3 Function
A02B-0326-J398	31i-B5 High-Speed HRV3 Function
A02B-0327-J398	31i-B High-Speed HRV3 Function
A02B-0328-J398	32i-B High-Speed HRV3 Function
A02B-0333-J398	35i-B High-Speed HRV3 Function
A02B-0334-J398	PM i-A High-Speed HRV3 Function

#### Notice

Certain functions may require additional hardware, different CPU type or additional memory capacity or may cause compatibility issue with other functions. In case of doubt, contact your FANUC sales representative for additional information and support.

The information given in the FANUC manuals or original manufacturer documentation shall prevail. Technical data is subject to change without prior notice. No part of this document may be reproduced in any form. All rights reserved. © FANUC 2017

# 081

## Controlled Axis

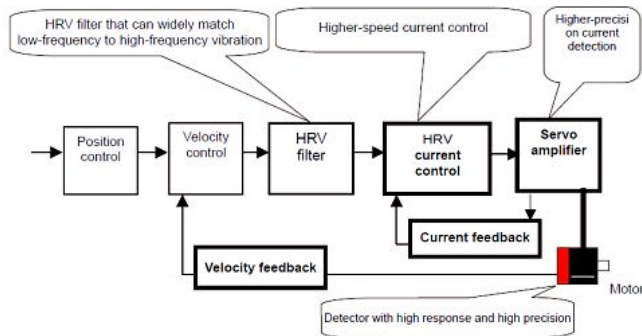

## HRV4 Control

### Features

SERVO HRV control is a digital servo current control methods. When using this method of control, higher speed, higher precision and higher acceleration can be achieved.

There are three types of SERVO HRV control available:

- SERVO HRV2 control
- SERVO HRV3 control
- SERVO HRV4 control

SERVO HRV control has three main features.

1. A disturbance elimination filter which eliminates the low-frequency vibration of a machine with low rigidity
2. Achievement of smooth feed with a high-precision servo amplifiers and detectors
3. The use of high-speed Digital Signal Processor (DSP) which allow a current control period much shorter than the conventional period achieved with standard systems (high-speed HRV current control)

SERVO HRV2 features a current loop of 125  $\mu$ s and is standard on the Series 30i-B CNC.

SERVO HRV3 features a current loop of 62.5  $\mu$ s and is particularly designed for demanding machining applications. It is standard on the Series 0i-F CNC.

SERVO HRV4 features a current loop of 31.25  $\mu$ s and has been designed for specific applications. It also features a faster position loop compared to the HRV2 and HRV3 functions.

### Benefits

- Very performant and scalable axis control

### Ordering Information

Specification	Description
A02B-0323-J399	30i-B High-Speed HRV4 Function
A02B-0326-J399	31i-B5 High-Speed HRV4 Function
A02B-0327-J399	31i-B High-Speed HRV4 Function

#### Notice

Certain functions may require additional hardware, different CPU type or additional memory capacity or may cause compatibility issue with other functions. In case of doubt, contact your FANUC sales representative for additional information and support.

The information given in the FANUC manuals or original manufacturer documentation shall prevail. Technical data is subject to change without prior notice. No part of this document may be reproduced in any form. All rights reserved. © FANUC 2017

# 082

## Controlled Axis

# Inch/Metric Conversion

---

## Features

The Inch / Metric Conversion function provides the possibility to switch units between the metric and the inch system within a program directly using a G code.

This function is a basic function in FANUC Series 0i-F.

## Benefits

- Very flexible programming

## Ordering Information

Specification	Description
A02B-0323-J876	30i-B Inch/Metric Conversion
A02B-0326-J876	31i-B5 Inch/Metric Conversion
A02B-0327-J876	31i-B Inch/Metric Conversion
A02B-0328-J876	32i-B Inch/Metric Conversion

### Notice

Certain functions may require additional hardware, different CPU type or additional memory capacity or may cause compatibility issue with other functions. In case of doubt, contact your FANUC sales representative for additional information and support.

The information given in the FANUC manuals or original manufacturer documentation shall prevail. Technical data is subject to change without prior notice. No part of this document may be reproduced in any form. All rights reserved. © FANUC 2017

# 083

## Controlled Axis

# Stored Stroke Check 1 Area Expansion

## Features

With the Stored Stroke Check function included in the Basic Function of the CNC, it is possible to switch the 2 checking areas with Digital Input signals.

The Stored Stroke Check 1 Area Expansion function expands the checking areas from 2 to 8.

It is easy to change the stored stroke check area in case of changes of the machine moving area such as during tool changing or tool measuring.

## Benefits

- Increase of the machine flexibility

## Ordering Information

Specification	Description
A02B-0323-R552	30i-B Stored Stroke Check, 1 Area Expansion
A02B-0326-R552	31i-B5 Stored Stroke Check, 1 Area Expansion
A02B-0327-R552	31i-B Stored Stroke Check, 1 Area Expansion
A02B-0328-R552	32i-B Stored Stroke Check, 1 Area Expansion
A02B-0339-R552	0i-TF Stored Stroke Check 1 Area Expansion
A02B-0340-R552	0i-MF Stored Stroke Check 1 Area Expansion

### Notice

Certain functions may require additional hardware, different CPU type or additional memory capacity or may cause compatibility issue with other functions. In case of doubt, contact your FANUC sales representative for additional information and support.

The information given in the FANUC manuals or original manufacturer documentation shall prevail. Technical data is subject to change without prior notice. No part of this document may be reproduced in any form. All rights reserved. © FANUC 2017

# 084

## Controlled Axis

# Stroke Limit External Setting

## Features

The Stroke Limit External Setting function allows the operator to set the desired stroke limit by moving the machine to a desired limit and use a push button to store values in stroke limit parameters.

When a new tool is mounted, the operator positions the tip of the tool on the two corners of the limit area and specifies the machine coordinates of the corners in the parameters for stroke limit 1. The machine coordinates are stored in the CNC as the limit positions.

The operator can then activate the input signals for setting the stroke limit. Stroke limit setting signals are provided for each axis and each direction.

Checking of the stroke limit can also be selected by turning on or off the limit release signal common to all axes.

This function is a basic function in FANUC Series 0i-F.

## Benefits

- Simplifies machining zone setting

## Ordering Information

Specification	Description
A02B-0323-J845	30i-B Stroke Limit External Setting
A02B-0326-J845	31i-B5 Stroke Limit External Setting
A02B-0327-J845	31i-B Stroke Limit External Setting
A02B-0328-J845	32i-B Stroke Limit External Setting

### Notice

Certain functions may require additional hardware, different CPU type or additional memory capacity or may cause compatibility issue with other functions. In case of doubt, contact your FANUC sales representative for additional information and support.

The information given in the FANUC manuals or original manufacturer documentation shall prevail. Technical data is subject to change without prior notice. No part of this document may be reproduced in any form. All rights reserved. © FANUC 2017

# 085

## Controlled Axis

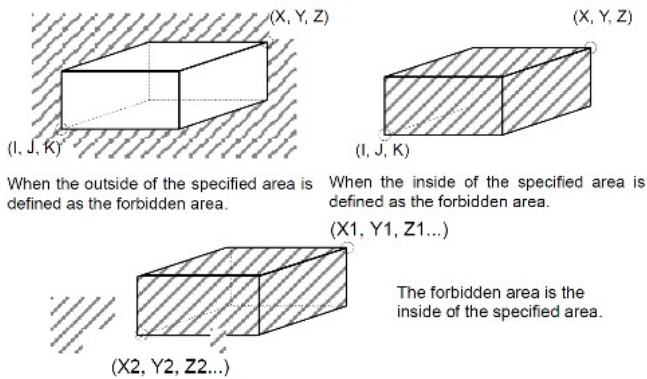

### Notice

Certain functions may require additional hardware, different CPU type or additional memory capacity or may cause compatibility issue with other functions. In case of doubt, contact your FANUC sales representative for additional information and support.

The information given in the FANUC manuals or original manufacturer documentation shall prevail. Technical data is subject to change without prior notice. No part of this document may be reproduced in any form. All rights reserved. © FANUC 2017

# Stored Stroke Check 2,3

## Features

The Stored Stroke Check 2 function allows the outside or inside of an area specified by parameters or a program to be defined as the forbidden area.

The operator specifies as a limit position a distance from the origin of the machine coordinate system. This function is enabled after manual reference position return is performed at power-on.

When the limits are specified in a program, they can be set for the X-, Y-, and Z-axes. For this reason, the forbidden area can be changed according to the workpiece. Whether to define the inside or outside of the specified area as the forbidden area is determined by setting the corresponding parameter.

Stored Stroke Check 3 defines the inside of a parameter- set area as a forbidden area.

When the Stored Stroke Check 2 or 3 functions and the Chuck/Tail Stock Barrier function are used at the same time, the Chuck/Tail Stock Barrier option is valid and the Stored Stroke Check 2 or 3 is ignored.

This function is a basic function in FANUC Series 0i-F.

## Benefits

- Possibility to implement safe machining zones in a machine
- Protects equipment against collisions

## Ordering Information

Specification	Description
A02B-0323-J840	30i-B Stored Stroke Check 2 and 3
A02B-0326-J840	31i-B5 Stored Stroke Check 2 and 3
A02B-0327-J840	31i-B Stored Stroke Check 2 and 3
A02B-0328-J840	32i-B Stored Stroke Check 2 and 3
A02B-0333-J840	35i-B Stored Stroke Check 2 and 3

# 086

## Controlled Axis

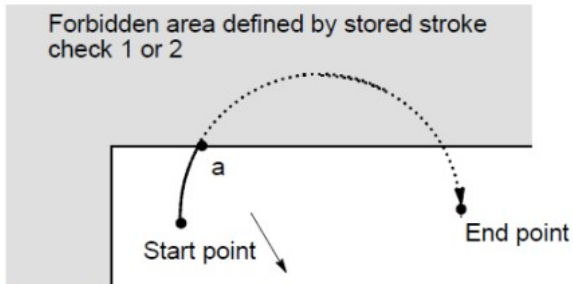

The tool is stopped at point a according to stored stroke check 1 or 2.

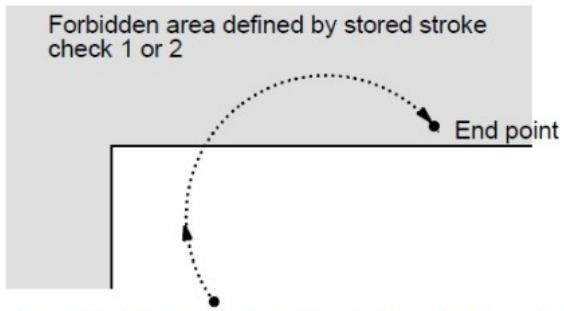

Immediately upon movement commencing from the start point, the tool is stopped to enable a stroke limit check before moving to be performed before movement.

### Notice

Certain functions may require additional hardware, different CPU type or additional memory capacity or may cause compatibility issue with other functions. In case of doubt, contact your FANUC sales representative for additional information and support.

The information given in the FANUC manuals or original manufacturer documentation shall prevail. Technical data is subject to change without prior notice. No part of this document may be reproduced in any form. All rights reserved. © FANUC 2017

# Stored Stroke Check Before Move

## Features

The Stored Stroke Check before Move function calculates the movement end point at the start of movement in a block, during automatic operation, based on the current machine position and the specified amount of travel, to check whether the end point falls within the inhibited area for stored stroke limit 1, 2, or 3.

If the end point falls within an inhibited area, the movement for that block is stopped immediately upon the start of movement and an alarm is issued.

This function is a basic function in FANUC Series 0i-F.

## Benefits

- Avoid axis displacement if a movement is supposed to reach a prohibited machining zone

## Ordering Information

Specification	Description
A02B-0323-J749	30i-B Stroke Limit Check before Move
A02B-0326-J749	31i-B5 Stroke Limit Check before Move
A02B-0327-J749	31i-B Stroke Limit Check before Move
A02B-0328-J749	0i-TF Stroke Limit Check before Move

# 087

## Controlled Axis

# Stroke Limit Area Changing Function

## Features

The Stroke Limit Area Changing function enables parameters setting that set the side boundary of the stroke limit during axis movement.

The setting of the parameters is available through the PMC window function (WINDW: SUB52), FOCAS2, and C language executor. The new forbidden area is enabled as soon as the writing parameters is completed.

## Note

The Stroke Limit Area Changing function is disabled when automatic slave axis parameter setting on feed axis synchronization is enabled. In this case, the parameters can only be written when all axes are stopped.

## Benefits

- The setting of the stroke limit can be customized, for instance through a specific HMI

## Ordering Information

Specification	Description
A02B-0323-R585	30i-B Stroke Limit Area Changing Function
A02B-0326-R585	31i-B5 Stroke Limit Area Changing Function
A02B-0327-R585	31i-B Stroke Limit Area Changing Function
A02B-0328-R585	32i-B Stroke Limit Area Changing Function
A02B-0333-R585	35i-B Stroke Limit Area Changing Function
A02B-0339-R585	0i-TF Stroke Limit Area Changing Function
A02B-0340-R585	0i-MF Stroke Limit Area Changing Function

### Notice

Certain functions may require additional hardware, different CPU type or additional memory capacity or may cause compatibility issue with other functions. In case of doubt, contact your FANUC sales representative for additional information and support.

The information given in the FANUC manuals or original manufacturer documentation shall prevail. Technical data is subject to change without prior notice. No part of this document may be reproduced in any form. All rights reserved. © FANUC 2017



# 088

## Controlled Axis

NO.	ADDRESS	DATA	NO.	ADDRESS	DATA	NO.	ADDRESS	DATA
0	D1100	2100000	12	D1148	0	24	D1196	0
1	D1104	2200000	13	D1152	0	25	D1200	0
2	D1108	-2100000	14	D1156	0	26	D1204	0
3	D1112	-2200000	15	D1160	0	27	D1208	0
4	D1116	3100000	16	D1164	0	28	D1212	0
5	D1120	3200000	17	D1168	0	29	D1216	0
6	D1124	-3100000	18	D1172	0	30	D1220	0
7	D1128	-3200000	19	D1176	0	31	D1224	0
8	D1132	0	20	D1180	0	32	D1228	0
9	D1136	0	21	D1184	0	33	D1232	0
10	D1140	0	22	D1188	0	34	D1236	0
11	D1144	0	23	D1192	0	35	D1240	0

# Stored Stroke Limit Range Switching Function by Signal

## Features

With this function, the Range Stored Stroke Limit can be switched by an input signal of the PMC. It is then possible to set the limit easily.

The ranges are stored in data tables in the PMC and signals can be used for switching on and off the limits.

## Benefits

- Simplified management of multiple zones directly from the PMC
- Protection of the machine and asset against destructive movements
- Overall improvement of the machine productivity

## Ordering Information

Specification	Description
A02B-0323-R849	30i-B Stored Stroke Limit Range Switching Function by Signal
A02B-0326-R849	31i-B5 Stored Stroke Limit Range Switching Function by Signal
A02B-0327-R849	31i-B Stored Stroke Limit Range Switching Function by Signal
A02B-0328-R849	32i-B Stored Stroke Limit Range Switching Function by Signal
A02B-0339-R849	0i-TF Stored Stroke Limit Range Switch Function by Signal
A02B-0340-R849	0i-MF Stored Stroke Limit Range Switch Function by Signal

### Notice

Certain functions may require additional hardware, different CPU type or additional memory capacity or may cause compatibility issue with other functions. In case of doubt, contact your FANUC sales representative for additional information and support.

The information given in the FANUC manuals or original manufacturer documentation shall prevail. Technical data is subject to change without prior notice. No part of this document may be reproduced in any form. All rights reserved. © FANUC 2017

# 089

## Controlled Axis

# Chuck and Tail Stock Barrier

## Features

The Chuck and Tail Stock Barrier function prevents damages to the machine by checking whether the tool tip interferes with either the chuck or tail stock.

This is realized when specifying an area into which the tool may not enter (entry-prohibition area). This is done using a special setting screen, according to the shapes of the chuck and tail stock.

If the tool tip would enter the set area during a machining operation, this function stops the tool and outputs an alarm message. The tool can be removed from the prohibited area only by retracting it in the direction from which the tool entered the area.

Note: when Stored Stroke Check 2 or 3 option and Chuck / Tail Stock Barrier option are used at the same time, the Chuck / Tail Stock Barrier option is valid and Stored Stroke Check 2 or 3 is ignored.

This function is a basic function in FANUC Series 0i-TF.

## Benefits

- Protection of the machine work space
- Protection against programming errors

## Ordering Information

Specification	Description
A02B-0323-J720	30i-B Chuck and Tail Stock Barrier
A02B-0326-J720	31i-B5 Chuck and Tail Stock Barrier
A02B-0327-J720	31i-B Chuck and Tail Stock Barrier
A02B-0328-J720	32i-B Chuck and Tail Stock Barrier

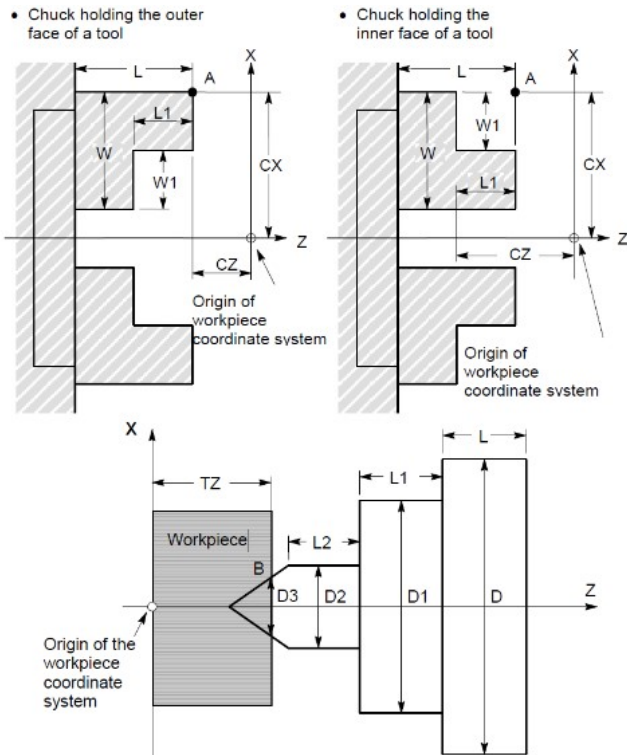

### Notice

Certain functions may require additional hardware, different CPU type or additional memory capacity or may cause compatibility issue with other functions. In case of doubt, contact your FANUC sales representative for additional information and support.

The information given in the FANUC manuals or original manufacturer documentation shall prevail. Technical data is subject to change without prior notice. No part of this document may be reproduced in any form. All rights reserved. © FANUC 2017

# 090

## Controlled Axis

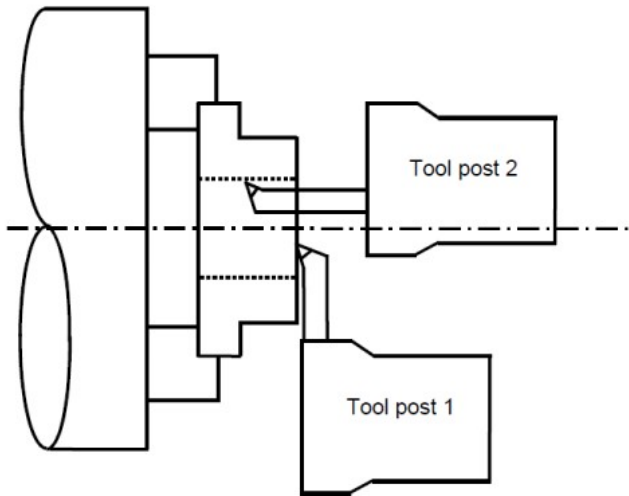

## Interference Check for Each Path

### Features

The Interference Check function checks the tool posts of multiple paths for collision possibilities.

When tool posts on individual paths machine the same workpiece simultaneously, the tool posts can approach each other very closely. If the tool posts interfere with each other due to a program error or any other setting error, serious damage such as tool or machine destruction can occur.

If a command that could cause that the tool posts of paths to interfere with each other is specified, the function gradually stops the tool posts before the tool posts actually interfere with each other.

The contours and shapes of the tool posts on individual paths are checked to determine whether or not interference occurs.

This function enables an interference check between two paths or interference check among multiple paths. The number of paths to check can be determined by parameter setting.

### Benefits

- Protection of the machine
- Ease the programming of multi-path systems
- Reduction of the downtime

### Ordering Information

Specification	Description
A02B-0323-J839	30i-B Interference Check for Each Path
A02B-0326-J839	31i-B5 Interference Check for Each Path
A02B-0327-J839	31i-B Interference Check for Each Path
A02B-0328-J839	32i-B Interference Check for Each Path
A02B-0339-J839	0i-TF Interference Check Each Path

#### Notice

Certain functions may require additional hardware, different CPU type or additional memory capacity or may cause compatibility issue with other functions. In case of doubt, contact your FANUC sales representative for additional information and support.

The information given in the FANUC manuals or original manufacturer documentation shall prevail. Technical data is subject to change without prior notice. No part of this document may be reproduced in any form. All rights reserved. © FANUC 2017

# 091

## Controlled Axis

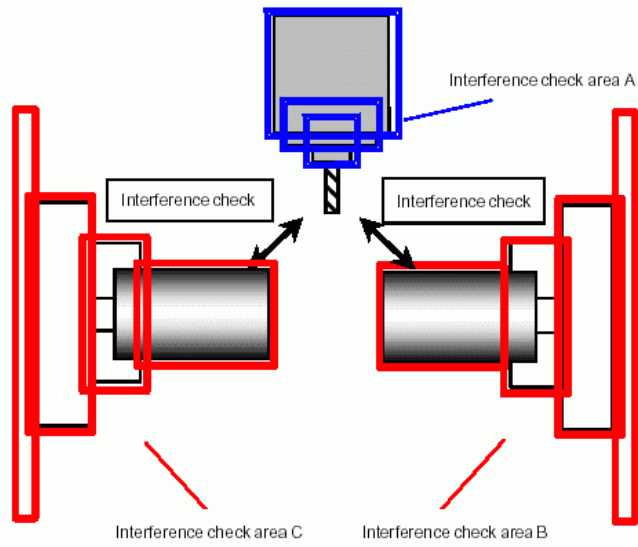

# Interference Check for Rotary Area

## Features

This function checks for interference among the tool post and chucks and stops the machine safely. Three major interference check areas can be set, each of which is specified by using rectangles. Two of the three interference check areas can be moved and rotated.

The following interference check areas can be set:

- Interference check area A and interference check area B with up to 4 rectangles. The entire area moves according to the movement along parameter-set two axes. In addition, the entire area can be rotated according to the rotation on a parameter-set axis.
- Interference check area C with up to 4 rectangles. The area cannot be moved and rotated.

## Benefits

- Protection of the machine
- Reduction of the downtime

## Ordering Information

Specification	Description
A02B-0323-S643	30i-B Interference Check for Rotary Area
A02B-0326-S643	31i-B5 Interference Check for Rotary Area
A02B-0327-S643	31i-B Interference Check for Rotary Area
A02B-0328-S643	32i-B Interference Check for Rotary Area

### Notice

Certain functions may require additional hardware, different CPU type or additional memory capacity or may cause compatibility issue with other functions. In case of doubt, contact your FANUC sales representative for additional information and support.

The information given in the FANUC manuals or original manufacturer documentation shall prevail. Technical data is subject to change without prior notice. No part of this document may be reproduced in any form. All rights reserved. © FANUC 2017

# 092

## Controlled Axis

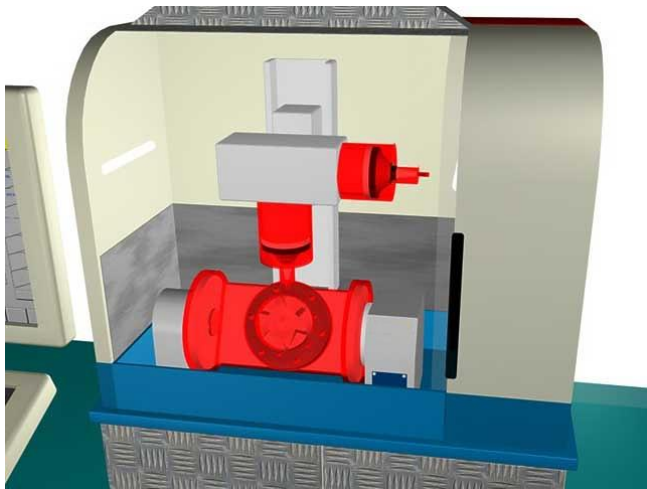

# Built-In 3D Interference Check

## Features

The 3D Interference Check function is an advanced anti collision function. The function is implemented directly into the CNC and has extremely rapid interference check in real time. The success in avoiding collisions is almost 100% - even when setting up or in manual mode. This function is available for both milling and turning machines and is particularly recommended for 5 axes machines or complex machines.

The critical working area of a machine can be emulated using geometric elements (planes, rectangular parallelepipeds and cylinders) that are defined using absolute dimensional data (to the micron) and work in conjunction with the programmed tool data taken from the normal CNC memory. The CNC will use this spatial data to determine whether any moving part of the machine may collide with fixed elements such as the table, fixtures and machine structure. All this occurs in realtime.

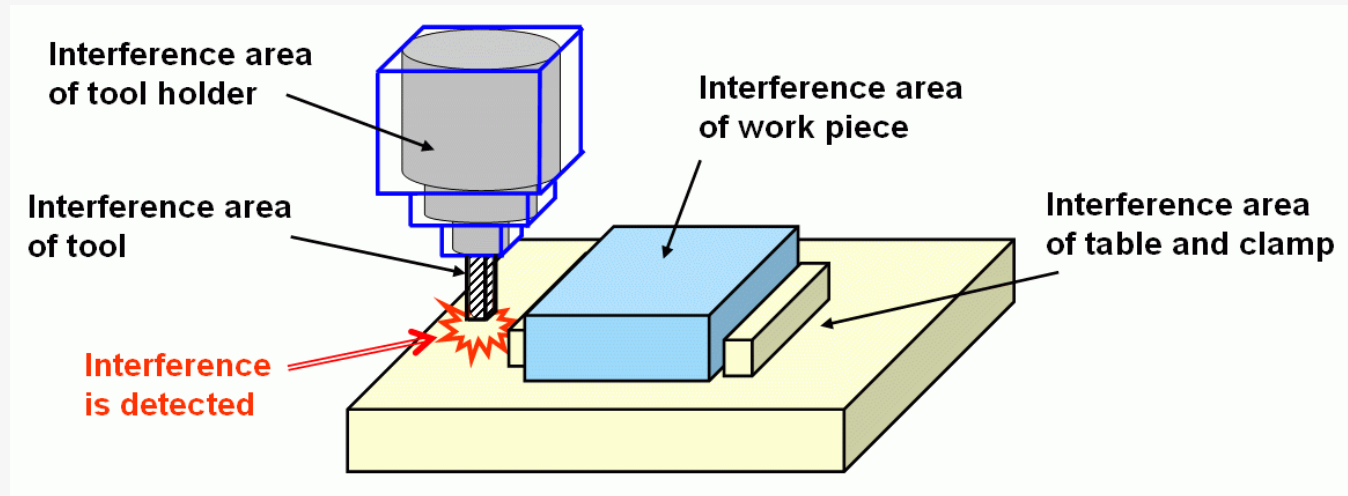

The collision can be checked by detecting the interference among machine parts such as tool, work-piece and table in three dimensional space in real time. This function is the measure for an expensive workpiece to be protected from being damaged. This function is also useful in manual operation, for example, for protection against malfunction during setup. Thus, the time required for setup can be reduced.

With the M series, the interference check targets include a tool, tool holder, workpiece, jig, and table. With the T series, the interference check targets include a single point tool + tip, tool post, workpiece, chuck, and spindle.

### Notice

Certain functions may require additional hardware, different CPU type or additional memory capacity or may cause compatibility issue with other functions. In case of doubt, contact your FANUC sales representative for additional information and support.

The information given in the FANUC manuals or original manufacturer documentation shall prevail. Technical data is subject to change without prior notice. No part of this document may be reproduced in any form. All rights reserved. © FANUC 2017

## Key functions

- 3D Interference Check Among Objects Like Tool, Work Piece, Etc.
- Each Interference Area of Tool or Work Piece or Table, Etc. Consists of Rectangular Parallelepipeds
- The function is effective also with 5-axis Machining (Rotary Tool, Table, Etc.)
- The function is available in both Auto and Manual modes
- The function is embedded in the CNC Kernel (High-Speed CPU is required)
- Up to 4 paths are supported
- Easy definition of interference check figure on setting screen: each objects can be built up with up to 6 shapes (Parallelepipeds, Cylinders or Planes). The system provides database information for up to 150 Shapes, which can be arbitrary combined to built up to 10 registerable tool holder and 10 registerable objects
- Interference check figures can be switched by the Part Program
- Each tool specified by the Parts Program is automatically considered as rectangular parallelepiped or cylinder of the proper size
- Interference between tool and workpiece is checked in rapid traverse

The PC software "Built-in 3D Interference Check Setting Tool is available to create the shapes and the 3D model of the machine working zone, the tool, holders and workpieces. It can import 3D object from CAD-CAM systems as well as show the process in real-time when connected to the CNC over Ethernet.

## Benefits

- No negative influence on the machining time
- Protect the machine, the tools and fixtures
- Reduced downtime
- Quick and easy to configure
- Minimal set-up time
- Manual adaptability, also possible for the end user, e.g. for automated machinery

## Ordering Information

Specification	Description
A02B-0323-R541	30i-B Built-in 3-D Interference Check Function
A02B-0326-R541	31i-B5 Built-in 3-D Interference Check Function
A02B-0327-R541	31i-B Built-in 3-D Interference Check Function
A02B-0328-R541	32i-B Built-in 3D Interference Check Function

### Notice

Certain functions may require additional hardware, different CPU type or additional memory capacity or may cause compatibility issue with other functions. In case of doubt, contact your FANUC sales representative for additional information and support.

The information given in the FANUC manuals or original manufacturer documentation shall prevail. Technical data is subject to change without prior notice. No part of this document may be reproduced in any form. All rights reserved. © FANUC 2017

# 094

## Controlled Axis

# 3D Interference Check with PC Function

## Features

3D interference check with Personal computer function supports a CAD system on PC so that its 3D animation can check for interference between the actual machine motion and a structure such as the tool, the workpiece, or the table.

## Benefits

- The use of these functions with a 3D animation can check machine interference to be detected before actual interference occurs, so the machine can be stopped immediately before the interference.

## Ordering Information

Specification	Description
A02B-0323-R542	30i-B 3-D Interference Check for CNC with PC Function
A02B-0326-R542	31i-B5 3-D Interference Check for CNC with PC Function
A02B-0327-R542	31i-B 3-D Interference Check for CNC with PC Function
A02B-0328-R542	32i-B 3-D Interference Check for CNC with PC Function

### Notice

Certain functions may require additional hardware, different CPU type or additional memory capacity or may cause compatibility issue with other functions. In case of doubt, contact your FANUC sales representative for additional information and support.

The information given in the FANUC manuals or original manufacturer documentation shall prevail. Technical data is subject to change without prior notice. No part of this document may be reproduced in any form. All rights reserved. © FANUC 2017

# 095

## Controlled Axis

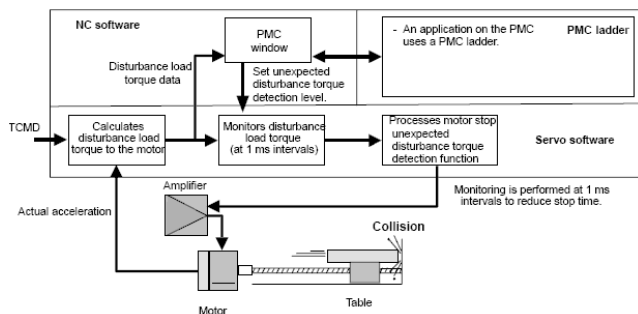

# Unexpected Disturbance Torque Detection Function

## Features

Machine collisions, as well as defective and damaged cutters impose a large load torque on the servo and spindle motors, compared with normal rapid traverse or cutting feed.

The Unexpected Disturbance Torque Detection function detects the disturbance torque on the motors and sends this value as an estimated load torque to the PMC.

If the detected disturbance torque value is outside of the specification / expected value (greater than the value specified in the corresponding parameter), the function either stops the servo motor as quickly as possible or reverses the motor by an appropriate value (as specified in another parameter), in order to minimize possible damage to the machine.

This function is a basic function in FANUC Series 0i-F.

## Benefits

- Detection of possible machine collision situations as well as other situations where damage may arise

## Ordering Information

Specification	Description
A02B-0323-J718	30i-B Unexpected Disturbance Torque Detection Function
A02B-0326-J718	31i-B5 Unexpected Disturbance Torque Detection Function
A02B-0327-J718	31i-B Unexpected Disturbance Torque Detection Function
A02B-0328-J718	32i-B Unexpected Disturbance Torque Detection Function
A02B-0333-J718	35i-B Unexpected Disturbance Torque Detection Function
A02B-0334-J718	PM i-A Unexpected Disturbance Torque Detection Function

### Notice

Certain functions may require additional hardware, different CPU type or additional memory capacity or may cause compatibility issue with other functions. In case of doubt, contact your FANUC sales representative for additional information and support.

The information given in the FANUC manuals or original manufacturer documentation shall prevail. Technical data is subject to change without prior notice. No part of this document may be reproduced in any form. All rights reserved. © FANUC 2017



# 096

## Controlled Axis

# Unexpected Disturbance Torque Detection for BETA i I/O Link

## Features

Machine collisions, as well as defective and damaged cutters impose a large load torque on the servo and spindle motors, compared with normal rapid traverse or cutting feed.

The Unexpected Disturbance Torque Detection function for BETA i I/O Link provides this function on the separate amplifiers of the BETA i series which can be connected to the CNC using the I/O Link network.

## Benefits

- Detection of possible machine collision situations as well as other situations where damage may arise

## Ordering Information

Specification	Description
A02B-0323-S812	30i-B BETA I/O LINK Unexpected Disturbance Torque Detection Function
A02B-0326-S812	31i-B5 BETA I/O LINK Unexpected Disturbance Torque Detection Function
A02B-0327-S812	31i-B BETA I/O LINK Unexpected Disturbance Torque Detection Function
A02B-0328-S812	32i-B BETA I/O LINK Unexpected Disturbance Torque Detection Function
A02B-0333-S812	35i-B BETA I/O LINK Unexpected Disturbance Torque Detection Function
A02B-0334-S812	PM i-A BETA I/O LINK Unexpected Disturbance Torque Detection Function
A02B-0339-S812	0i-TF I/O LINK BETA Unexpected Disturbance Torque Detection
A02B-0340-S812	0i-MF I/O LINK BETA Unexpected Disturbance Torque Detection

### Notice

Certain functions may require additional hardware, different CPU type or additional memory capacity or may cause compatibility issue with other functions. In case of doubt, contact your FANUC sales representative for additional information and support.

The information given in the FANUC manuals or original manufacturer documentation shall prevail. Technical data is subject to change without prior notice. No part of this document may be reproduced in any form. All rights reserved. © FANUC 2017

# 097

## Controlled Axis



### Notice

Certain functions may require additional hardware, different CPU type or additional memory capacity or may cause compatibility issue with other functions. In case of doubt, contact your FANUC sales representative for additional information and support.

The information given in the FANUC manuals or original manufacturer documentation shall prevail. Technical data is subject to change without prior notice. No part of this document may be reproduced in any form. All rights reserved. © FANUC 2017

# Fine Torque Sensing

## Features

The Fine Torque Sensing function stores the disturbance torque detected by a servo motor or a spindle motor in the internal memory of the CNC for later evaluation and analysis.

Following operations are available for the stored torque data:

- The stored torque data can be read via the window function of the PMC and be used in the PMC program for actions
- Statistics data (average, maximum, dispersion) of the stored torque is calculated by the CNC, and the results of these statistical calculation can also be read using the window function of the PMC
- The stored torque data can be displayed graphically on Torque Graph Screen of the CNC and displayed on the operation screen
- The detection level of the unexpected disturbance load torque alarm can be set on Torque Graph Screen. To use this capability, the Unexpected Disturbance Torque Detection function must be set in the CNC
- The stored torque data can be saved into the F-ROM memory of the CNC as sample data, and it is possible to compare this stored values graphically with other reference torque data.
- The stored torque data can also be saved to the memory card.

## Notes

- In the stand-alone type CNC and the 15 inch LCD mounted CNC of the Series 30i, this function and the communication to Personal Computer or Panel i via HSSB cannot be used at the same time.
- In the 7.2 inch, 8.4 inch and 10.4 inch LCD mounted type CNC Series, this function and the communication to Personal Computer or Panel i via the 2nd HSSB channel cannot be used at the same time.

## Benefits

- Advanced function to analyse the torque behaviour during machining
- Possibility to visualize and set limits for the Disturbance Load detection directly on the screen
- Possibility to monitor torque behaviour to find issues on the mechanical structure of the machine
- Analysis of the actual behaviour of the machine versus a stored reference profile

## Ordering Information

Specification	Description
A02B-0323-J982	30i-B Fine Torque Sensing - Cannot be Specified with Open CNC PANEL i 15.0" LCD
A02B-0326-J982	31i-B5 Fine Torque Sensing - Cannot be Specified with Open CNC PANEL i 15.0" LCD
A02B-0327-J982	31i-B Fine Torque Sensing - Cannot be Specified with Open CNC PANEL i 15.0" LCD

# 098

## Controlled Axis

# Rotary Axis Control

---

## Features

The Rotary Axis Control function controls a rotary axis as specified by an absolute command. With this function, the sign of the value specified in the command is interpreted as the direction of rotation, and the absolute value of the specified value is interpreted as the coordinates of the target end position.

This function is valid when rotary axis roll-over is enabled. If the parameter is set, an absolute command specified for the rollover rotary axis is interpreted as follows: the sign and absolute value of the value specified in the command represent the direction of rotation and the end position of movement respectively.

## Benefits

- Simplifies the management of rotary axes

## Ordering Information

Specification	Description
A02B-0323-J743	30i-B Rotary Axis Control
A02B-0326-J743	31i-B5 Rotary Axis Control
A02B-0327-J743	31i-B Rotary Axis Control
A02B-0328-J743	32i-B Rotary Axis Control

### Notice

Certain functions may require additional hardware, different CPU type or additional memory capacity or may cause compatibility issue with other functions. In case of doubt, contact your FANUC sales representative for additional information and support.

The information given in the FANUC manuals or original manufacturer documentation shall prevail. Technical data is subject to change without prior notice. No part of this document may be reproduced in any form. All rights reserved. © FANUC 2017

# 099

## Controlled Axis

# Position Switch

## Features

The Position Switch function outputs signals to the PMC while the machine coordinates along a controlled axes are within a parameter-specified ranges. This creates a virtual "cam switch" function.

Using parameters, it is possible to specify arbitrary controlled axes and machine coordinate operating ranges for which position switch signals are output.

Up to 10 position switch signals can be output. Parameter can be set to use up to 16 position switch signals.

This function is a basic function in FANUC Series 0i-F.

## Benefits

- A signal can be sent to machine at certain positions to initiate automatic actions
- No hardware to adjust to change "trip" positions of up to 10 switches - Just change coordinate value in parameters
- Improves machine reliability by simplifying machine wiring

## Ordering Information

Specification	Description
A02B-0323-J846	30i-B Position Switch
A02B-0326-J846	31i-B5 Position Switch
A02B-0327-J846	31i-B Position Switch
A02B-0328-J846	32i-B Position Switch

### Notice

Certain functions may require additional hardware, different CPU type or additional memory capacity or may cause compatibility issue with other functions. In case of doubt, contact your FANUC sales representative for additional information and support.

The information given in the FANUC manuals or original manufacturer documentation shall prevail. Technical data is subject to change without prior notice. No part of this document may be reproduced in any form. All rights reserved. © FANUC 2017

# 100

## Controlled Axis

# High-Speed Position Switch

## Features

The High-Speed Position Switch function monitors the current position at shorter intervals than the normal position switch function to output a high-speed precise position switch signal.

In the same way as for the normal position switch function, it is possible to set parameters to specify arbitrary controlled axes and machine coordinate operating ranges for which position switch signals are output.

Up to 6 high-speed position signals can be output. Additional settings are available to use up to 16 high-speed position switch signals.

## Benefits

- A high-speed signal can be sent to the machine at certain positions to initiate automatic actions
- No hardware to adjust to change "trip" positions of up to 6 switches - Just change coordinate value in parameters
- Improves machine reliability by simplifying machine wiring

## Ordering Information

Specification	Description
A02B-0323-J987	30i-B High-Speed Position Switch
A02B-0326-J987	31i-B5 High-Speed Position Switch
A02B-0327-J987	31i-B High-Speed Position Switch
A02B-0328-J987	32i-B High-Speed Position Switch
A02B-0333-R704	35i-B High-Speed Position Switch - Incl. Direction-Dependent Type of High-Speed Position Switch
A02B-0334-R704	PM i-A High-Speed Position Switch
A02B-0339-J987	0i-TF High-Speed Position Switch
A02B-0340-J987	0i-MF High-Speed Position Switch

### Notice

Certain functions may require additional hardware, different CPU type or additional memory capacity or may cause compatibility issue with other functions. In case of doubt, contact your FANUC sales representative for additional information and support.

The information given in the FANUC manuals or original manufacturer documentation shall prevail. Technical data is subject to change without prior notice. No part of this document may be reproduced in any form. All rights reserved. © FANUC 2017

# 101

## Controlled Axis

# Direction-Dependent Type of High-Speed Position Switch

## Features

The High-Speed Position Switch function monitors the machine coordinates and move direction to output high-speed position switch signals to drive additional processes on the machine.

Two machine coordinates are monitored. When the tool passes through one coordinate in the specified direction, the high-speed position switch signal is set to 1. When it passes through the other coordinate in the specified direction, the signal is set to 0.

The output mode of high-speed position switch signals (normal type or direction-dependent type) is set using parameters.

## Benefits

- A high-speed signal can be sent to the machine at certain positions to initiate automatic actions
- Actions can be set depending on the movement direction
- No hardware to adjust to change "trip" positions of the switches
- Improves machine reliability by simplifying machine wiring

## Ordering Information

Specification	Description
A02B-0323-S721	30i-B Direction-Dependent Type of High-Speed Position Switch
A02B-0326-S721	31i-B5 Direction-Dependent Type of High-Speed Position Switch
A02B-0327-S721	31i-B Direction-Dependent Type of High-Speed Position Switch
A02B-0328-S721	32i-B Direction-Dependent Type of High-Speed Position Switch

### Notice

Certain functions may require additional hardware, different CPU type or additional memory capacity or may cause compatibility issue with other functions. In case of doubt, contact your FANUC sales representative for additional information and support.

The information given in the FANUC manuals or original manufacturer documentation shall prevail. Technical data is subject to change without prior notice. No part of this document may be reproduced in any form. All rights reserved. © FANUC 2017

# 102

## Controlled Axis

Reference mark 1 Reference mark 2 Reference mark 1 Reference mark 2 Reference mark 1

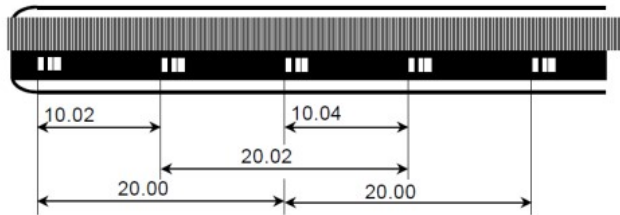

## Linear Scale Interface with Absolute Address Reference Mark

### Features

The Linear Scale Interface with Absolute Address (Distance Coded) Reference Mark function, an absolute position can be identified with a distance coded linear/rotary encoder.

For calculating the absolute position the axis must detect minimum 2 reference marks. In this case, a reference position can be established at any position of the axis by short distance movement.

### A/B-phase Interface - Absolute Address Referenced Mark

- The encoder with Absolute Address Referenced Mark (A/B-phase) interface requires the SDU (Separate Detector Unit).
- The encoder is then used as separate feedback
- In this case a fully closed system is created

### Serial type Interface - Distance Coded Reference Marks

- The encoder with Distance Coded Reference Marks and with sinusoidal 1Vpp interface requires the High Resolution Serial Output Circuit (type C)
- If the High Resolution Output Circuit is connected to the servo amplifier, then the encoder is used as motor feedback; in this case a semi-closed system is created
- If the High Resolution Output Circuit is connected to the SDU, then the encoder is used as separate feedback; in this case a fully closed system is created

Note for the Linear Scale with Absolute Address Reference Mark Expansion function: when a G00 command or a move command based on jog feed are specified, this function enables a reference mark interval measurement to be made automatically in order to establish a reference position.

### Benefits

- Simplified integration of distance coded scales
- Increase of the precision of the machine tool

#### Notice

Certain functions may require additional hardware, different CPU type or additional memory capacity or may cause compatibility issue with other functions. In case of doubt, contact your FANUC sales representative for additional information and support.

The information given in the FANUC manuals or original manufacturer documentation shall prevail. Technical data is subject to change without prior notice. No part of this document may be reproduced in any form. All rights reserved. © FANUC 2017

## Ordering Information

Specification	Description
A02B-0323-J670	30i-B Linear Scale Interface with Absolute Address Reference Mark
A02B-0323-S730	30i-B Linear Scale Interface Expansion with Absolute Address Reference Mark
A02B-0326-J670	31i-B5 Linear Scale Interface with Absolute Address Reference Mark
A02B-0326-S730	31i-B5 Linear Scale Interface Expansion with Absolute Address Reference Mark
A02B-0327-J670	31i-B Linear Scale Interface with Absolute Address Reference Mark
A02B-0327-S730	31i-B Linear Scale Interface Expansion with Absolute Address Reference Mark
A02B-0328-J670	32i-B Linear Scale Interface with Absolute Address Reference Mark
A02B-0328-S730	32i-B Linear Scale Interface Expansion with Absolute Address Reference Mark
A02B-0333-J670	35i-B Linear Scale Interface with Absolute Address Reference Mark
A02B-0333-S730	35i-B Linear Scale Interface Expansion with Absolute Address Reference Mark
A02B-0334-J670	PM i-A Linear Scale Interface with Absolute Address Reference Mark
A02B-0334-S730	PM i-A Linear Scale Interface Expansion with Absolute Address Reference Mark
A02B-0339-J670	0i-TF Linear Scale Interface with Absolute Address Reference Mark
A02B-0339-S730	0i-TF Linear Scale with Absolute Address Reference Mark Expansion
A02B-0340-J670	0i-MF Linear Scale Interface with Absolute Reference Mark
A02B-0340-S730	0i-MF Linear Scale with Absolute Address Reference Mark Expansion

### Notice

Certain functions may require additional hardware, different CPU type or additional memory capacity or may cause compatibility issue with other functions. In case of doubt, contact your FANUC sales representative for additional information and support.

The information given in the FANUC manuals or original manufacturer documentation shall prevail. Technical data is subject to change without prior notice. No part of this document may be reproduced in any form. All rights reserved. © FANUC 2017



# 104

## Controlled Axis

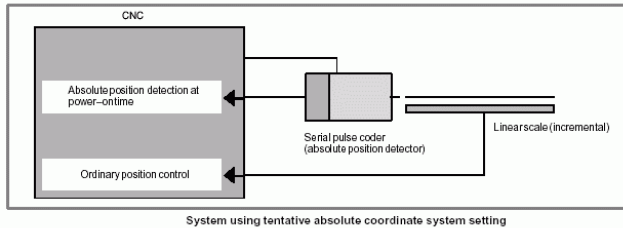

## Temporary Absolute Coordinate Setting

### Features

In a full-closed system with a built-in absolute position detector (serial pulse coder) and incremental linear scale, a coordinate system can be set up using the absolute position data received from the built-in absolute position detector when the power is switched on.

After the startup procedure, the position control is carried out using the linear scale with incremental data.

Since the machine position obtained immediately after the power is switched on is tentative, obtaining the accurate machine position requires making a manual reference position return.

For safety reasons and before a reference position return is made, this function enables a stroke limit, although the machine position obtained when the power is switched on is approximate.

Note that this function does not substitute to the use of a real absolute detection system as the main position measurement remains incremental.

### Benefits

- Provides a simplified startup procedure for incremental scales

### Ordering Information

Specification	Description
A02B-0323-J786	30i-B Temporary Absolute Coordinate Setting
A02B-0326-J786	31i-B5 Temporary Absolute Coordinate Setting
A02B-0327-J786	31i-B Temporary Absolute Coordinate Setting
A02B-0328-J786	32i-B Temporary Absolute Coordinate Setting
A02B-0339-J786	0i-TF Temporary Absolute Coordinate Setting
A02B-0340-J786	0i-MF Temporary Absolute Coordinate Setting

#### Notice

Certain functions may require additional hardware, different CPU type or additional memory capacity or may cause compatibility issue with other functions. In case of doubt, contact your FANUC sales representative for additional information and support.

The information given in the FANUC manuals or original manufacturer documentation shall prevail. Technical data is subject to change without prior notice. No part of this document may be reproduced in any form. All rights reserved. © FANUC 2017

# 105

## Controlled Axis

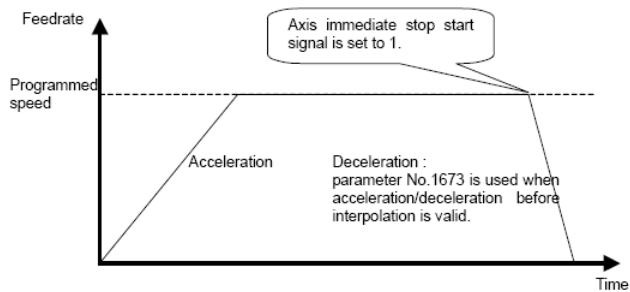

## Axis Immediate Stop Function

### Features

The Axis Immediate Stop function can be used to stop motors immediately during AI Contour Control and control the position at the same time.

This mode of operation can be required on certain machine where the immediate stop by emergency stop is not sufficient, for instance since it does not control position.

### Procedure

- Change of acceleration / deceleration before interpolation in AI contour mode
- Feed axes stop
- Output of an alarm message

### Notes

- AI Contour Control I (S807) or AI Contour Control II (S808) option is required.

This function cannot be performed to an axis under the the control with following functions.

- PMC axis control
- Chopping function
- Polygon turning
- EGB function
- Live tool control with servo motor
- Spindle control of Cs contouring control

### Benefits

- Reduction of the stop distance by changing the acceleration rate of the acceleration/deceleration before interpolation
- The position control remains valid during a series of stop sequence
- Safer and controlled stop to protect the machine

### Ordering Information

Specification	Description
A02B-0323-R613	30i-B Axis Immediate Stop Function
A02B-0326-R613	31i-B5 Axis Immediate Stop Function

#### Notice

Certain functions may require additional hardware, different CPU type or additional memory capacity or may cause compatibility issue with other functions. In case of doubt, contact your FANUC sales representative for additional information and support.

The information given in the FANUC manuals or original manufacturer documentation shall prevail. Technical data is subject to change without prior notice. No part of this document may be reproduced in any form. All rights reserved. © FANUC 2017

# 106

Specification	Description
A02B-0327-R613	31i-B Axis Immediate Stop Function
A02B-0339-R613	0i-TF Axis Immediate Stop Function
A02B-0340-R613	0i-MF Axis Immediate Stop Function

## Notice

Certain functions may require additional hardware, different CPU type or additional memory capacity or may cause compatibility issue with other functions. In case of doubt, contact your FANUC sales representative for additional information and support.

The information given in the FANUC manuals or original manufacturer documentation shall prevail. Technical data is subject to change without prior notice. No part of this document may be reproduced in any form. All rights reserved. © FANUC 2017

# 107

## Controlled Axis

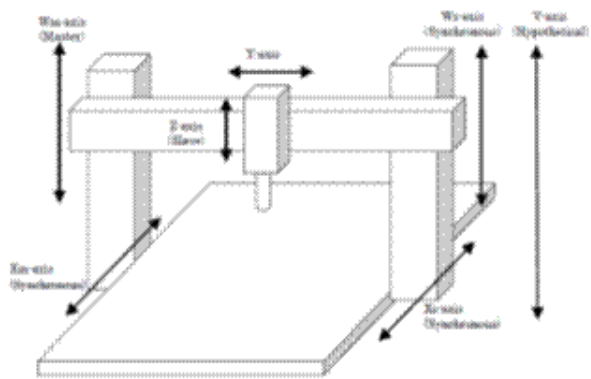

Fig. 1.1 (a) Example of machine structure

## Cross Rail Axis Control

### Features

This function controls two parallel axes, coupled directly (e.g. telescopic axis) or indirectly (e.g. via cross rail). Such architecture is controlled by a single axis command.

### Benefits

- Support of special axes architectures comprising two linked, parallel axes.
- Easy Programming by single axis command
- Supports most features including 5-axis features
- This function cannot be specified together with Parallel Axis Control (-R509)

### Ordering Information

Specification	Description
A02B-0323-R415	30i-B Cross Rail Axis Control
A02B-0326-R415	31i-B5 Cross Rail Axis Control
A02B-0327-R415	31i-B Cross Rail Axis Control

### Notice

Certain functions may require additional hardware, different CPU type or additional memory capacity or may cause compatibility issue with other functions. In case of doubt, contact your FANUC sales representative for additional information and support.

The information given in the FANUC manuals or original manufacturer documentation shall prevail. Technical data is subject to change without prior notice. No part of this document may be reproduced in any form. All rights reserved. © FANUC 2017

# 108

## Controlled Axis

# Multi-Axes Synchronous Function (Power Motion i-A)

---

## Features

The multi-axes synchronous function allows axes (child axes) to synchronously follow up the operation of a reference axis (parent axis) with a certain speed ratio (gear ratio)

This function not only facilitates simplification of gears and other mechanism but also allows the speed ratio to be changed freely during operation, therefore enabling operations that could not be performed with conventional mechanisms.

## Benefits

- Since the speed ratio (gear ratio) is determined by command data of the PMC axis control, operations that frequently change the gear ratio or the direction of movement can be performed.
- The speed ratio (gear ratio) is set by specifying the amount of a parent-axis movement and the amount of a child-axis movement separately rather than specifying a ratio directly, so the problem of fraction processing does not occur. As a result, the synchronization relationship does not deviate even after rotation is performed continuously.
- Axes can have a hierarchical structure not only having a parent-child relationship but also having grandchildren and further lower levels as long as the maximum allowable number of axes is not exceeded.
- The parent-child relationship of axes is established by setting parameters considering safety.

## Ordering Information

Specification	Description
A02B-0334-R403	PM i-A Multi-Axes Synchronous Function

### Notice

Certain functions may require additional hardware, different CPU type or additional memory capacity or may cause compatibility issue with other functions. In case of doubt, contact your FANUC sales representative for additional information and support.

The information given in the FANUC manuals or original manufacturer documentation shall prevail. Technical data is subject to change without prior notice. No part of this document may be reproduced in any form. All rights reserved. © FANUC 2017

# 109

## Controlled Axis

# Multi-Axes High-Response Function

## Features

The Multi-Axes High-Response Function adds a high-response mode to the control. The cycle time to check external signals in high-response mode is faster than in normal mode. Therefore, if a program is executed in high-response mode, the axes can be started or stopped with external signal faster than in normal mode. Programs have to be compiled before they can be executed in high-response mode. Up to 24 programs can be executed simultaneously.

## Benefits

- Reduces cycle time and increases productivity

## Ordering Information

Specification	Description
A02B-0334-R396	PM i-A Multi-Axes High-Response Function (Max. 1 Path / 24 Axes)

### Notice

Certain functions may require additional hardware, different CPU type or additional memory capacity or may cause compatibility issue with other functions. In case of doubt, contact your FANUC sales representative for additional information and support.

The information given in the FANUC manuals or original manufacturer documentation shall prevail. Technical data is subject to change without prior notice. No part of this document may be reproduced in any form. All rights reserved. © FANUC 2017

# 110

## Controlled Axis

# Skip Function for Multi-Axes High-Response Function

---

## Features

The Skip Function for Multi-Axes High-Response Function allows to use the skip function in the high-response mode. With this, it is possible to measure workpiece position and dimension in high-response mode.

## Note

The Multi-Axes High-Response Function is necessary to use this function.

## Benefits

- Extends the application range of the Multi-Axes High-Response Function

## Ordering Information

Specification	Description
A02B-0334-R398	PM i-A Skip Function for Multi-Axes High-Response Function (Max. 24 Skip Signals)

### Notice

Certain functions may require additional hardware, different CPU type or additional memory capacity or may cause compatibility issue with other functions. In case of doubt, contact your FANUC sales representative for additional information and support.

The information given in the FANUC manuals or original manufacturer documentation shall prevail. Technical data is subject to change without prior notice. No part of this document may be reproduced in any form. All rights reserved. © FANUC 2017

# 111

## Controlled Axis

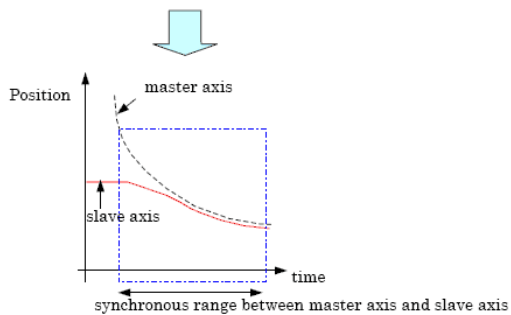
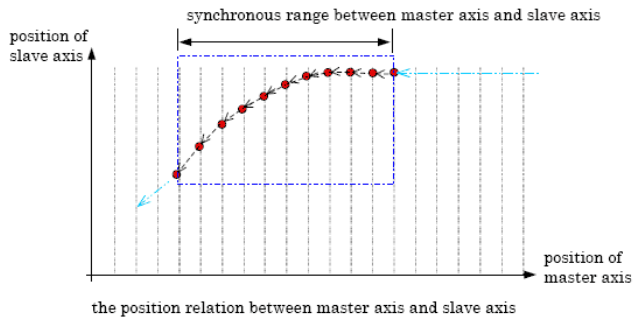

# Position Definition Type Synchronous Function

## Features

An axis may synchronize the movement with another axis only in the specific range.

This function enables that the slave axis synchronizes the movement with the master axis within the specified range of the master axis according to the data of the position relation between the master axis and the slave axis that had been defined beforehand. This function is executed in the high response mode.

Up to 8 kinds of the position relation data can be registered.

Plural slave axes can be selected for the same position relation data at the same time. But the plural different position relation data can not be selected for plural slave axes at the same time.

Only one master axis can be specified.

## Ordering Information

Specification	Description
A02B-0334-R399	PM i-A Position Definition Type Synchronous Function

### Notice

Certain functions may require additional hardware, different CPU type or additional memory capacity or may cause compatibility issue with other functions. In case of doubt, contact your FANUC sales representative for additional information and support.

The information given in the FANUC manuals or original manufacturer documentation shall prevail. Technical data is subject to change without prior notice. No part of this document may be reproduced in any form. All rights reserved. © FANUC 2017



# 112

## Controlled Axis

# Pressure and Position Control Function

## Overview

The pressure and position control function enables a positional control command and pressure control command to be executed at the same time. The function is an axis control function that automatically selects and exercises position control based on a positional control command when no force is applied to the tool in an axis direction, and automatically selects and exercises pressure control based on a pressure command when an external force is applied to the tool in an axis direction.

For example, the function enables the tool to approach a workpiece in an axis direction by using position control until the tool touches the workpiece. The function can then exercise pressure control with a specified pressure while the tool is touching the workpiece in the axis direction. When the tool is separated from the workpiece, the function can move the tool to a specified position by position control.

With the Power Motion i-A, this function requires high-speed response characteristics, so that the optional function of the HIGH RESPONSE FUNCTION is needed.

## Analog Monitor Unit

The 'Analog Monitor Unit' is connected to FSSB line to input an analog current signal to Power Motion i-A in combination with the 'Pressure and Position Control Function'. There are 4 analog current input channels available on the unit. The maximum total number of 'Analog Monitor Units' and 'Separate Detector Interface Units' that can be connected to an FSSB line is 4 for HRV2, and 2 for HRV3.

## Ordering Information

Specification	Description
A02B-0334-C231	Analog Monitor Unit (4 Channels) - for Pressure and Position Control
A02B-0334-R400	PM i-A Pressure and Position Control Function

### Notice

Certain functions may require additional hardware, different CPU type or additional memory capacity or may cause compatibility issue with other functions. In case of doubt, contact your FANUC sales representative for additional information and support.

The information given in the FANUC manuals or original manufacturer documentation shall prevail. Technical data is subject to change without prior notice. No part of this document may be reproduced in any form. All rights reserved. © FANUC 2017

# 113

## Controlled Axis

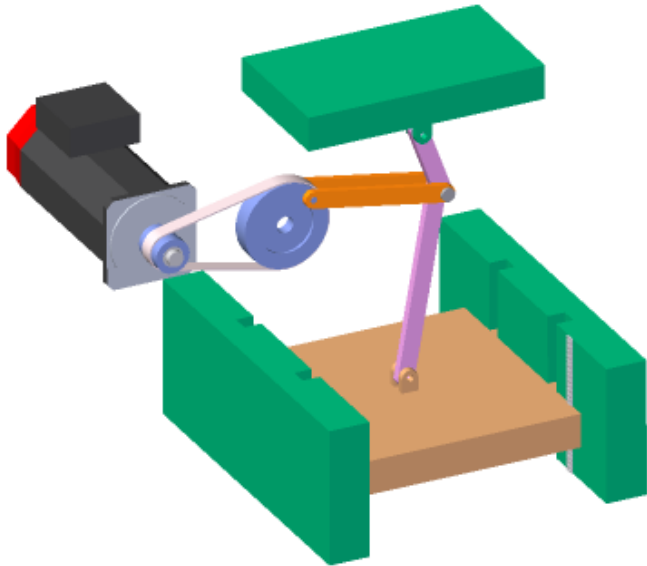

## Control Function for Link Type Press

### Features

In the rotary link type press mechanism, the deceleration ratio in the slider part changes according to the angle of the main gear. With the Control Function for Link Type Press, the internal value of the position gain is corrected by a gain multiplier according to the angle of the main gear in order to keep the effective position gain constant.

Two different control methods are available. In the rotation control method, the position control is performed based on the feedback of the main gear. In the reverse control method, the position control is performed based on the feedback of the slider.

### Benefits

- Support of link type press mechanisms

### Ordering Information

Specification	Description
A02B-0334-S603	PM i-A Control Function for Link Type Press

#### Notice

Certain functions may require additional hardware, different CPU type or additional memory capacity or may cause compatibility issue with other functions. In case of doubt, contact your FANUC sales representative for additional information and support.

The information given in the FANUC manuals or original manufacturer documentation shall prevail. Technical data is subject to change without prior notice. No part of this document may be reproduced in any form. All rights reserved. © FANUC 2017

# 114

## Controlled Axis

# Servo-On Synchronize Function

## Features

Conventionally, for a coasting axis under a servo-off condition, when the servo-off signal is released to set a servo-on condition while a move command is entered, a step for canceling an accumulated amount of servo position error is triggered. The step involves abrupt deceleration and then acceleration, preventing a smooth start of the move command.

This feed function uses the actual rate at the instant of servo-on condition setting as an initial rate, thereby starting operation smoothly at a specified acceleration or deceleration.

## Ordering Information

Specification	Description
A02B-0334-R395	PM i-A Servo-On Synchronize Function

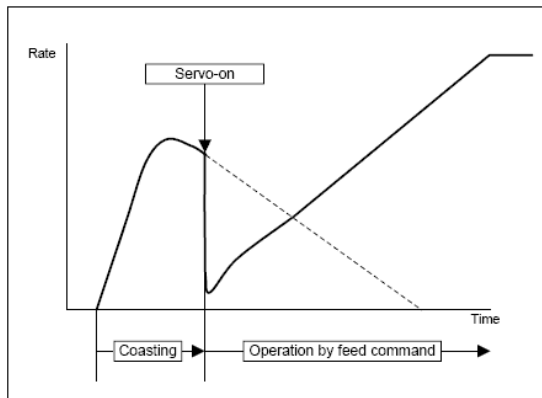

Fig. 1 Conventional Operation

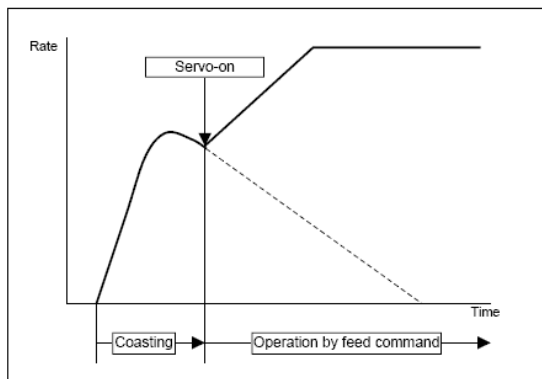

Fig. 2 Operation with Servo-on Synchronize Function

### Notice

Certain functions may require additional hardware, different CPU type or additional memory capacity or may cause compatibility issue with other functions. In case of doubt, contact your FANUC sales representative for additional information and support.

The information given in the FANUC manuals or original manufacturer documentation shall prevail. Technical data is subject to change without prior notice. No part of this document may be reproduced in any form. All rights reserved. © FANUC 2017

# 115

## Controlled Axis

# Position Control Keep Function

---

## Features

With the Position Control Keep Function, it is possible to prevent the automatic switching from position control to pressure control when using the Pressure and Position Control Function. If a dedicated input signal is activated, the control will not switch the correspondent axis to pressure control mode and stay in position control mode.

## Note

The Multi-Axes High-Response Function and the Pressure and Position Control Function are required to use this function.

## Benefits

- Prevents unexpected switching to pressure control mode

## Ordering Information

Specification	Description
A02B-0334-R401	PM i-A Position Control Keep Function

### Notice

Certain functions may require additional hardware, different CPU type or additional memory capacity or may cause compatibility issue with other functions. In case of doubt, contact your FANUC sales representative for additional information and support.

The information given in the FANUC manuals or original manufacturer documentation shall prevail. Technical data is subject to change without prior notice. No part of this document may be reproduced in any form. All rights reserved. © FANUC 2017

# 116

## Controlled Axis

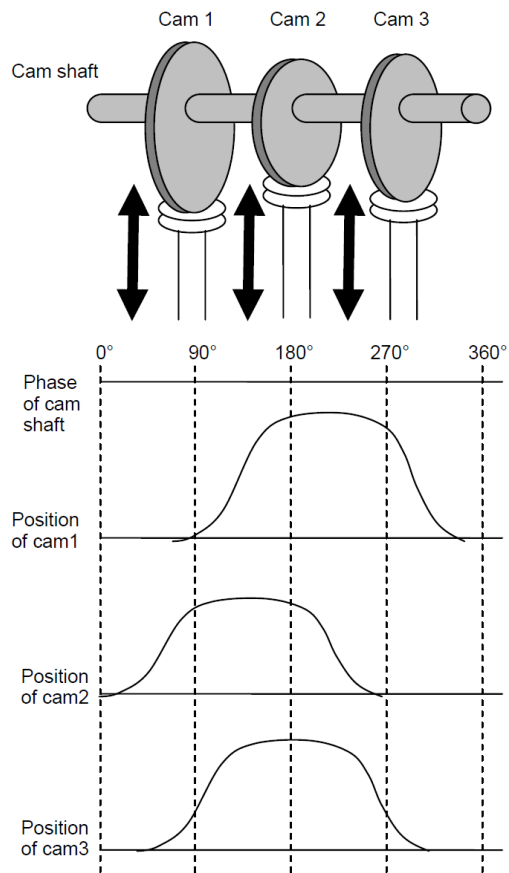

### Notice

Certain functions may require additional hardware, different CPU type or additional memory capacity or may cause compatibility issue with other functions. In case of doubt, contact your FANUC sales representative for additional information and support.

The information given in the FANUC manuals or original manufacturer documentation shall prevail. Technical data is subject to change without prior notice. No part of this document may be reproduced in any form. All rights reserved. © FANUC 2017

## Electronic Cam Function

### Features

The Electronic Cam Function electronically creates a motion of the cam follower that is synchronized with the motion of the cam shaft. The shapes of the cams are registered in the CNC beforehand. The CNC reads the data and moves the cam follower synchronized with the motion of the cam shaft.

Up to 4 cam followers can be synchronized with a cam shaft. Three different kinds of cam shafts are available with this function:

- An externally controlled axis with a rotary pulse coder attached to it.
- A servo axis which is controlled by the CNC.
- A hypothetical axis which is controlled by the CNC.

With this function, it is possible to replace mechanical cam shafts.

### Benefits

- Scales down the machine's size and reduces costs
- No wear, no lifetime issues of mechanical components
- No errors due to insufficient mechanical precision

### Ordering Information

Specification	Description
A02B-0334-R402	PM i-A Electronic Cam Function

# 117

## Functions

## Operation

---

This section of the catalogue contains the functions related to operation or ease of operation of the CNC system.

The CNCs feature powerful functions for programming and/or operating the machine. Some of these functions are specifically designed for Turning Machines, some are for Machining Centers and some can be used in both applications.

Some of the operation functions detailed in the catalogue:

- Referencing
- Manual functions
- Assisted manual functions
- Program stop and restart
- Tool retract and recover
- 3-dimensional manual functions
- Etc.

### Notice

Certain functions may require additional hardware, different CPU type or additional memory capacity or may cause compatibility issue with other functions. In case of doubt, contact your FANUC sales representative for additional information and support.

The information given in the FANUC manuals or original manufacturer documentation shall prevail. Technical data is subject to change without prior notice. No part of this document may be reproduced in any form. All rights reserved. © FANUC 2017

# 118

## Operation

# Sequence Number Comparison and Stop

## Features

The Sequence Number Comparison and Stop function can be used by the operator during the setup phase of a parts program.

The operator can set a sequence number through the MDI panel. When a block containing the specified sequence number appears in the program being executed, the machine operation enters the single block mode after the block is executed. This function is useful for checking a program, because the program can be stopped at a desired position without modifying the program.

This function is a basic function in FANUC Series 0i-F.

## Benefits

- Simplifies program check
- Reduces the commissioning time and increases efficiency

## Ordering Information

Specification	Description
A02B-0323-J844	30i-B Sequence Number Comparison & Stop
A02B-0326-J844	31i-B5 Sequence Number Comparison & Stop
A02B-0327-J844	31i-B Sequence Number Comparison & Stop
A02B-0328-J844	32i-B Sequence Number Comparison & Stop

### Notice

Certain functions may require additional hardware, different CPU type or additional memory capacity or may cause compatibility issue with other functions. In case of doubt, contact your FANUC sales representative for additional information and support.

The information given in the FANUC manuals or original manufacturer documentation shall prevail. Technical data is subject to change without prior notice. No part of this document may be reproduced in any form. All rights reserved. © FANUC 2017

# 119

## Operation

# Program Restart

## Features

With the Program Restart function, the operator can restart machining from a desired block by specifying the sequence number of the desired block or by specifying the number of blocks from the beginning of the program to the block at which he wishes machining to restart.

This function is a basic function in FANUC Series 0i-F.

## Benefits

- Enables the operator to restart the program following an interruption such as a tool break or a tool change, or following cancellation of an emergency-stop
- Allows for safe restarting of the program when the machine has been left in an unknown state – following a shift change or a vacation break, for instance
- A programmer or operator can use this function as a mechanism to check out a new or revised part program. By specifying the restart at that block in the program where changes have been made, for instance, he can test out precisely the affected portion

## Ordering Information

Specification	Description
A02B-0323-J838	30i-B Program Restart
A02B-0326-J838	31i-B5 Program Restart
A02B-0327-J838	31i-B Program Restart
A02B-0328-J838	32i-B Program Restart

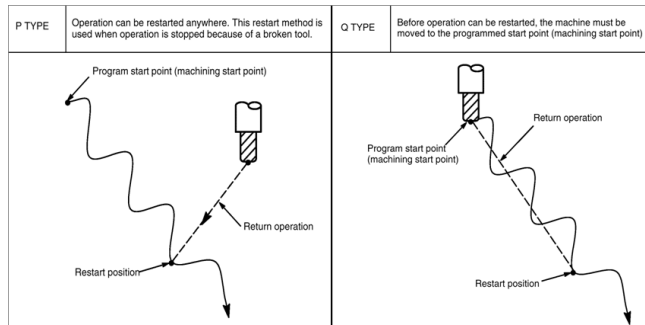

### Notice

Certain functions may require additional hardware, different CPU type or additional memory capacity or may cause compatibility issue with other functions. In case of doubt, contact your FANUC sales representative for additional information and support.

The information given in the FANUC manuals or original manufacturer documentation shall prevail. Technical data is subject to change without prior notice. No part of this document may be reproduced in any form. All rights reserved. © FANUC 2017



# 120

## Operation

# Auxiliary Function Output During Program Restart

## Features

The Auxiliary Function Output During Program Restart function intercepts the M/S/T/B codes encountered during Program Restart (i.e. between the start of the program and the specified Program Restart block) and outputs those codes to the MDI screen in the correct sequence.

## Benefits

- Relieves the operator of the task of re-keying the MDI codes currently displayed during Program Restart
- Ensures that all M/S/T/B codes encountered during Program Restart are output to MDI screen display and are executed in the correct sequence (current Program Restart function limits the number of codes displayed, which may cause the operator to miss some codes that may have fallen out of the display buffer)
- Macro call M-codes are executed properly when encountered

## Ordering Information

Specification	Description
A02B-0323-R576	30i-B Output of Auxiliary Function in Program Restart Function
A02B-0326-R576	31i-B5 Output of Auxiliary Function in Program Restart Function
A02B-0327-R576	31i-B Output of Auxiliary Function in Program Restart Function
A02B-0328-R576	32i-B Output of Auxiliary Function in Program Restart Function

### Notice

Certain functions may require additional hardware, different CPU type or additional memory capacity or may cause compatibility issue with other functions. In case of doubt, contact your FANUC sales representative for additional information and support.

The information given in the FANUC manuals or original manufacturer documentation shall prevail. Technical data is subject to change without prior notice. No part of this document may be reproduced in any form. All rights reserved. © FANUC 2017

# 121 Operation



## Quick Program Restart

### Features

The Quick Program Restart function includes the conventional Program Restart functionality and provides additionally multiple ways of efficient program restart based on program restart memory.

Appropriate information on a dedicated screen helps the operator to select the restarting block easily.

With the newer function "Quick Program Restart II" the restart processing time is shortened in long part program by using direct search method. Only machining center systems can use the "Quick Program Restart II" function.

### Benefits

- Enables the operator to restart the program following an interruption such as a tool break or a tool change, or following cancellation of an emergency-stop
- Allows for safe restarting of the program when the machine has been left in an unknown state – following a shift change or a vacation break, for instance
- Allows for efficient restarting of the program when operating with large part programs and the machine state can be easily preset manually
- A programmer or operator can use this function as a mechanism to check out a new or revised part program. By specifying the restart at that block in the program where changes have been made, for instance, he can test out precisely the affected portion

### Ordering Information

Specification	Description
A02B-0323-R630	30i-B Quick Program Restart
A02B-0326-R414	31i-B5 Quick Program Restart II
A02B-0326-R630	31i-B5 Quick Program Restart
A02B-0327-R414	31i-B Quick Program Restart II
A02B-0327-R630	31i-B Quick Program Restart
A02B-0328-R414	32i-B Quick Program Restart II
A02B-0328-R630	32i-B Quick Program Restart
A02B-0339-R630	0i-TF Quick Program Restart
A02B-0340-R414	0i-MF Quick Program Restart II
A02B-0340-R630	0i-MF Quick Program Restart

### Notice

Certain functions may require additional hardware, different CPU type or additional memory capacity or may cause compatibility issue with other functions. In case of doubt, contact your FANUC sales representative for additional information and support.

The information given in the FANUC manuals or original manufacturer documentation shall prevail. Technical data is subject to change without prior notice. No part of this document may be reproduced in any form. All rights reserved. © FANUC 2017

# 122

## Operation

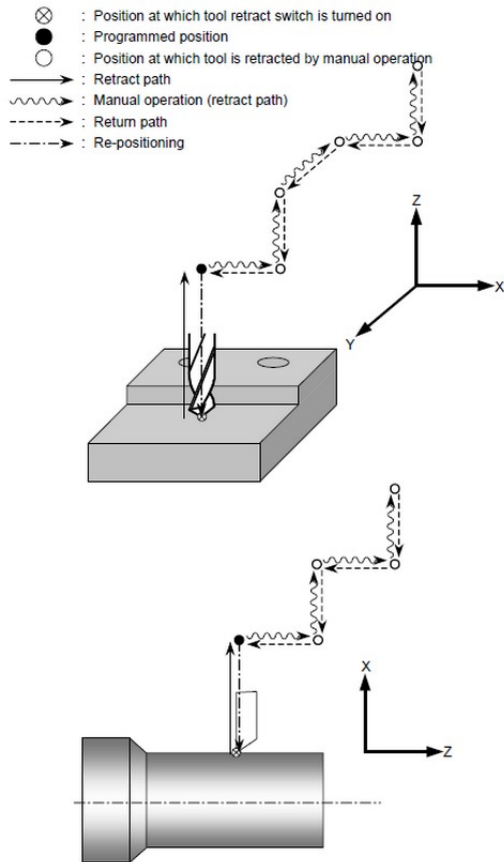

### Notice

Certain functions may require additional hardware, different CPU type or additional memory capacity or may cause compatibility issue with other functions. In case of doubt, contact your FANUC sales representative for additional information and support.

The information given in the FANUC manuals or original manufacturer documentation shall prevail. Technical data is subject to change without prior notice. No part of this document may be reproduced in any form. All rights reserved. © FANUC 2017

# Tool Retract and Recover

## Features

With the Tool Retract and Recover function the tool can be retracted from the workpiece when it is damaged, when it has to be replaced or when status of the machining has to be checked. The retraction position has to be specified with a program in advance. Afterwards the tool is returned to the workpiece and machining is restarted.

## Example of sequence

1. When tool retraction signal is set during the execution of an automatic operation, the retraction is performed up to the retraction position specified in the program.
2. The operator switches to manual mode and moves the tool in manual operation (jog feed, incremental feed, handle feed and manual numeric command). Up to ten movement paths are automatically stored.
3. When the tool recovery signal is set, the tool automatically returns to the retraction position, moving backward along the paths along which it has moved with manual operations.
4. With cycle start, a recovery (repositioning) is performed up to the position at which the tool retraction signal was set.

## Benefits

- Enables the operator to restart the program following an interruption such as a tool break or a tool change, or following cancellation of an emergency-stop
- Allows for safe restarting of the program when the machine has been left in an unknown state
- Reduction of time loss after tool break to restart operation

## Ordering Information

Specification	Description
A02B-0323-J823	30i-B Tool Retract and Recover
A02B-0326-J823	31i-B5 Tool Retract and Recover
A02B-0327-J823	31i-B Tool Retract and Recover
A02B-0328-J823	32i-B Tool Retract and Recover
A02B-0339-J823	0i-TF Tool Retract and Recover
A02B-0340-J823	0i-MF Tool Retract and Recover

# 123

## Operation

1. The N1 block cuts a workpiece.

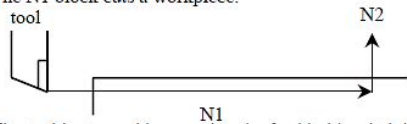

2. The tool is stopped by pressing the feed hold switch in the middle of the N1 block (point A).

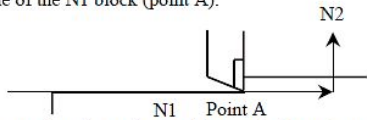

3. After retracting the tool manually to point B, tool movement is restarted.

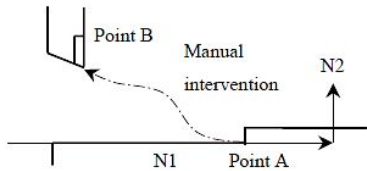

4. After automatic return to point A at the dry run feedrate by the non-linear interpolation type positioning, the remaining move command of the N1 block is executed.

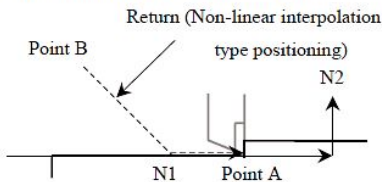

### Notice

Certain functions may require additional hardware, different CPU type or additional memory capacity or may cause compatibility issue with other functions. In case of doubt, contact your FANUC sales representative for additional information and support.

The information given in the FANUC manuals or original manufacturer documentation shall prevail. Technical data is subject to change without prior notice. No part of this document may be reproduced in any form. All rights reserved. © FANUC 2017

# Manual Intervention and Return

## Features

With the Manual Intervention and Return function, if the tool movement is stopped by a feed hold during automatic operation, then restarted after manual intervention for the confirmation of the cutting surface etc, the tool moves back to the point before intervention and automatic operation is resumed.

This function is a basic function in FANUC Series 0i-MF and 0i-TF.

## Benefits

- Simplifies operator intervention
- Improves machining productivity

## Ordering Information

Specification	Description
A02B-0323-R623	30i-B Manual Intervention and Return
A02B-0326-R623	31i-B5 Manual Intervention and Return
A02B-0327-R623	31i-B Manual Intervention and Return
A02B-0328-R623	32i-B Manual Intervention and Return

# 124

## Operation

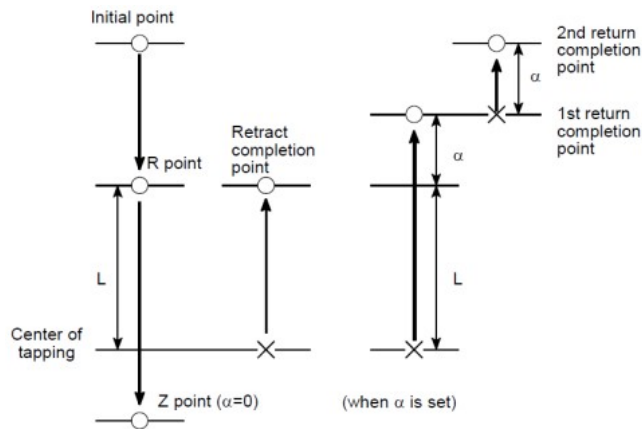

### Notice

Certain functions may require additional hardware, different CPU type or additional memory capacity or may cause compatibility issue with other functions. In case of doubt, contact your FANUC sales representative for additional information and support.

The information given in the FANUC manuals or original manufacturer documentation shall prevail. Technical data is subject to change without prior notice. No part of this document may be reproduced in any form. All rights reserved. © FANUC 2017

# Retraction for Rigid Tapping

## Features

The Retraction for Rigid Tapping function provides a way to restart a tapping operation.

When rigid tapping is stopped, either as a result of an emergency stop or a reset, the tap may cut into the workpiece. To avoid this, the tap can be drawn out using a PMC signal. The function automatically stores information related to the tapping executed most recently. Then, when a tap retraction signal is given, the tap is removed from the hole, based on the stored information. The tap is pulled toward the R point.

When a retract value ALPHA is given as parameter, the retraction distance can be increased by ALPHA.

This function is a basic function in FANUC Series 0i-MF.

## Benefits

- Simplifies operator intervention on tapping operations
- Improves machining productivity

## Ordering Information

Specification	Description
A02B-0323-J664	30i-B Rigid Tapping Retract
A02B-0326-J664	31i-B5 Rigid Tapping Retract
A02B-0327-J664	31i-B Rigid Tapping Retract
A02B-0328-J664	32i-B Rigid Tapping Retract
A02B-0339-J664	0i-TF Retraction of Rigid Tapping

# 125

## Operation

# Retraction for 3-Dimensional Rigid Tapping

## Features

When the 3-dimensional rigid tapping or the rigid tapping during Tilted Working Plane (TWP) command is stopped by a result of the CNC power off, an emergency stop or a reset, the tap may cut into the workpiece. The tap can subsequently be drawn out by using a PMC signal or a program command.

This function automatically stores the information relating to the rigid tapping executed most recently. When a tap retraction signal is input or G30 program is commanded, the tap is removed from the hole, based on the stored information. The tap is pulled toward the R point.

When a retract value ALPHA is set in parameter, the retraction distance can be increased by ALPHA.

## Benefits

- Simplifies operator intervention on tapping operations
- Improves machining productivity

## Ordering Information

Specification	Description
A02B-0323-R575	30i-B 3-D Rigid Tapping Retract
A02B-0326-R575	31i-B5 3-D Rigid Tapping Retract
A02B-0327-R575	31i-B 3-D Rigid Tapping Retract
A02B-0328-R575	32i-B 3-D Rigid Tapping Retract
A02B-0339-R575	0i-TF Retraction for 3-Dimensional Rigid Tapping
A02B-0340-R575	0i-MF Retraction for 3-Dimensional Rigid Tapping

### Notice

Certain functions may require additional hardware, different CPU type or additional memory capacity or may cause compatibility issue with other functions. In case of doubt, contact your FANUC sales representative for additional information and support.

The information given in the FANUC manuals or original manufacturer documentation shall prevail. Technical data is subject to change without prior notice. No part of this document may be reproduced in any form. All rights reserved. © FANUC 2017

# 126

## Operation

# Manual 2nd/3rd/4th Reference Position Return

## Features

The Manual 2nd/3rd/4th Reference Position Return function enables the 2nd, 3rd or 4th reference position return by JOG feed operation in manual reference position return mode.

## Benefits

- Simplifies operator intervention
- Improves machining productivity

## Ordering Information

Specification	Description
A02B-0323-R558	30i-B Manual 2nd/3rd/4th Reference Position Return
A02B-0326-R558	31i-B5 Manual 2nd/3rd/4th Reference Position Return
A02B-0327-R558	31i-B Manual 2nd/3rd/4th Reference Position Return
A02B-0328-R558	32i-B Manual 2nd/3rd/4th Reference Position Return
A02B-0339-R558	0i-TF Manual 2nd/3rd/4th Reference Position Return Function
A02B-0340-R558	0i-MF Manual 2nd/3rd/4th Reference Position Return Function

### Notice

Certain functions may require additional hardware, different CPU type or additional memory capacity or may cause compatibility issue with other functions. In case of doubt, contact your FANUC sales representative for additional information and support.

The information given in the FANUC manuals or original manufacturer documentation shall prevail. Technical data is subject to change without prior notice. No part of this document may be reproduced in any form. All rights reserved. © FANUC 2017

# 127

## Operation

# Reference Point Setting with Mechanical Stopper

## Features

This function automates the procedure of butting the tool against a mechanical stopper on an axis to set a reference position.

This function is a basic function in FANUC Series 0i-F.

## Benefits

- Eliminate the variations in reference position setting that arise depending on the operator
- Minimize work required to make fine adjustments after reference position setting

## Ordering Information

Specification	Description
A02B-0323-J729	30i-B Mechanical Stopper Referencing
A02B-0326-J729	31i-B5 Mechanical Stopper Referencing
A02B-0327-J729	31i-B Mechanical Stopper Referencing
A02B-0328-J729	32i-B Mechanical Stopper Referencing

### Notice

Certain functions may require additional hardware, different CPU type or additional memory capacity or may cause compatibility issue with other functions. In case of doubt, contact your FANUC sales representative for additional information and support.

The information given in the FANUC manuals or original manufacturer documentation shall prevail. Technical data is subject to change without prior notice. No part of this document may be reproduced in any form. All rights reserved. © FANUC 2017



# 128

## Operation

# Reference Point Setting with Mechanical Stopper for Feed Axis Synchronization Control

## Features

This function enables the reference point setting with mechanical stopper method if the axis is under feed axis synchronization control. The reference point setting is performed to the master axis and the slave axis of the feed axis synchronization control.

## Benefits

- Expand the application range of the reference point setting with mechanical stopper method

## Ordering Information

Specification	Description
A02B-0323-R627	30i-B Reference Position Setting with Mechanical Stopper for Feed Axis Synchronization Control
A02B-0326-R627	31i-B5 Reference Position Setting with Mechanical Stopper for Feed Axis Synchronization Control
A02B-0327-R627	31i-B Reference Position Setting with Mechanical Stopper for Feed Axis Synchronization Control
A02B-0328-R627	32i-B Reference Position Setting with Mechanical Stopper for Feed Axis Synchronization Control
A02B-0333-R627	35i-B Reference Position Setting with Mechanical Stopper for Feed Axis Synchronization Control
A02B-0334-R627	PM i-A Reference Position Setting with Mechanical Stopper for Feed Axis Synchronisation Control

### Notice

Certain functions may require additional hardware, different CPU type or additional memory capacity or may cause compatibility issue with other functions. In case of doubt, contact your FANUC sales representative for additional information and support.

The information given in the FANUC manuals or original manufacturer documentation shall prevail. Technical data is subject to change without prior notice. No part of this document may be reproduced in any form. All rights reserved. © FANUC 2017

# 129

## Operation

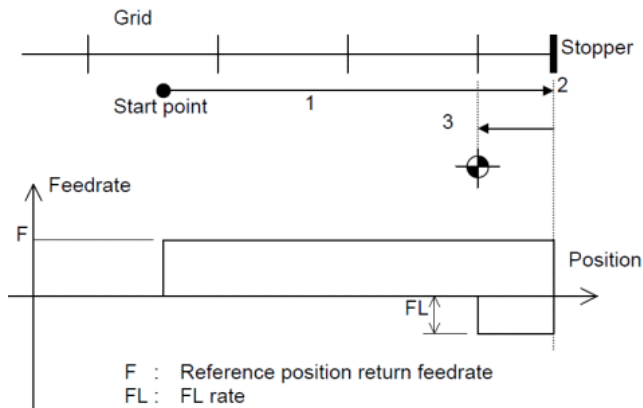

# Reference Point Setting with Mechanical Stopper by Grid Method

## Features

A reference position return for an axis can be made by pushing the axis against the mechanical stopper without using a limit switch or deceleration dog.

As this reference position setting uses a grid method, its precision is on the same level as for a manual reference position return.

## Benefits

- Use with Absolute Pulse Encoders to quickly establish a reference point without slow-down switches

## Ordering Information

Specification	Description
A02B-0323-S945	30i-B Reference Position Setting with Mechanical Stopper by Grid Method
A02B-0326-S945	31i-B5 Reference Position Setting with Mechanical Stopper by Grid Method
A02B-0327-S945	31i-B Reference Position Setting with Mechanical Stopper by Grid Method
A02B-0328-S945	32i-B Reference Position Setting with Mechanical Stopper by Grid Method
A02B-0333-S945	35i-B Reference Position Setting with Mechanical Stopper by Grid Method
A02B-0334-S945	PM i-A Reference Position Setting with Mechanical Stopper by Grid Method
A02B-0339-S945	0i-TF Reference Position Setting with Mechanical Stopper by Grid Method
A02B-0340-S945	0i-MF Reference Position Setting with Mechanical Stopper by Grid Method

### Notice

Certain functions may require additional hardware, different CPU type or additional memory capacity or may cause compatibility issue with other functions. In case of doubt, contact your FANUC sales representative for additional information and support.

The information given in the FANUC manuals or original manufacturer documentation shall prevail. Technical data is subject to change without prior notice. No part of this document may be reproduced in any form. All rights reserved. © FANUC 2017

# 130

## Operation

# Manual Handle Feed 1 Unit

## Features

The Manual Handle Feed 1-Unit function allows a manual pulse generator to be connected in order to allow the operator to command machine moves by turning the manual handle.

By rotating the manual pulse generator on the machine operator's panel in handle mode, an axis feed corresponding to the amount of rotation can be performed. A desired axis can be selected using the handle axis selection switch.

Connection of the manual pulse generator requires an appropriate I/O device with an Manual Pulse Generator (MPG) connection.

This function is a basic function in FANUC Series 0i-F.

## Benefits

- Simplifies operator intervention
- Improves machining productivity

## Ordering Information

Specification	Description
A02B-0323-J835	30i-B Manual Handle Feed 1 Unit
A02B-0326-J835	31i-B5 Manual Handle Feed 1 Unit
A02B-0327-J835	31i-B Manual Handle Feed 1 Unit
A02B-0328-J835	32i-B Manual Handle Feed 1 Unit

### Notice

Certain functions may require additional hardware, different CPU type or additional memory capacity or may cause compatibility issue with other functions. In case of doubt, contact your FANUC sales representative for additional information and support.

The information given in the FANUC manuals or original manufacturer documentation shall prevail. Technical data is subject to change without prior notice. No part of this document may be reproduced in any form. All rights reserved. © FANUC 2017

# 131

## Operation

# Manual Handle Feed 2/3 Units

## Features

The Manual Handle Feed 2/3-Units function allows the connection of up to two additional manual pulse generators for the Manual Handle Feed function.

This function is a basic function in FANUC Series 0i-F.

## Benefits

- Simplifies operator intervention
- Improves machining productivity

## Ordering Information

Specification	Description
A02B-0323-J836	30i-B Manual Handle Feed 2/3 Units
A02B-0326-J836	31i-B5 Manual Handle Feed 2/3 Units
A02B-0327-J836	31i-B Manual Handle Feed 2/3 Units
A02B-0328-J836	32i-B Manual Handle Feed 2/3 Units
A02B-0333-J836	35i-B Manual Handle Feed 2/3 Units
A02B-0334-J836	PM i-A Manual Handle Feed 2/3 Units

### Notice

Certain functions may require additional hardware, different CPU type or additional memory capacity or may cause compatibility issue with other functions. In case of doubt, contact your FANUC sales representative for additional information and support.

The information given in the FANUC manuals or original manufacturer documentation shall prevail. Technical data is subject to change without prior notice. No part of this document may be reproduced in any form. All rights reserved. © FANUC 2017

# 132

## Operation

# Manual Handle Feed 4/5 Units

## Features

The Manual Handle Feed 4/5-Units function allows the connection of up to two additional manual pulse generators for the Manual Handle Feed function.

## Benefits

- Simplifies operator intervention
- Improves machining productivity

## Ordering Information

Specification	Description
A02B-0323-S858	30i-B Manual Handle Feed 4/5 Units
A02B-0326-S858	31i-B5 Manual Handle Feed 4/5 Units
A02B-0327-S858	31i-B Manual Handle Feed 4/5 Units
A02B-0328-S858	32i-B Manual Handle Feed 4/5 Units
A02B-0339-S858	0i-TF Manual Handle Feed 4/5 Unit
A02B-0340-S858	0i-MF Manual Handle Feed 4/5 Unit

### Notice

Certain functions may require additional hardware, different CPU type or additional memory capacity or may cause compatibility issue with other functions. In case of doubt, contact your FANUC sales representative for additional information and support.

The information given in the FANUC manuals or original manufacturer documentation shall prevail. Technical data is subject to change without prior notice. No part of this document may be reproduced in any form. All rights reserved. © FANUC 2017

# 133

## Operation

# Manual Handle Feed - Multiple 10 Million

## Features

With the Manual Handle Feed - Multiple 10 Million, machines using small least input increment such as IS-D and IS-E can obtain more amounts of the movement when using manual handle feed.

This function extends the magnification of feed amount on manual handle feed, up to 10 million times of least input increment per pulse.

## Benefits

- High-precision coasting movements in manual mode
- Improves precision

## Ordering Information

Specification	Description
A02B-0323-R600	30i-B Manual Handle Feed, Multiple 10 Million
A02B-0326-R600	31i-B5 Manual Handle Feed, Multiple 10 Million
A02B-0327-R600	31i-B Manual Handle Feed, Multiple 10 Million
A02B-0328-R600	32i-B Manual Handle Feed, Multiple 10 Million

### Notice

Certain functions may require additional hardware, different CPU type or additional memory capacity or may cause compatibility issue with other functions. In case of doubt, contact your FANUC sales representative for additional information and support.

The information given in the FANUC manuals or original manufacturer documentation shall prevail. Technical data is subject to change without prior notice. No part of this document may be reproduced in any form. All rights reserved. © FANUC 2017

# 134

## Operation

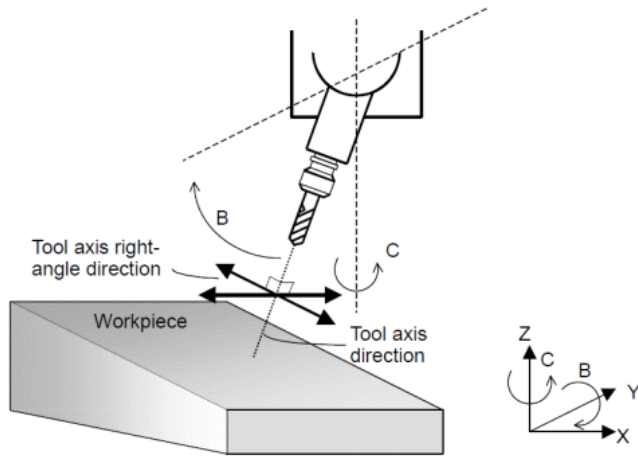

## 3-Dimensional Manual Feed

### Features

The function 3-Dimensional Manual Feed (previously Manual Handle Feed for 5-Axis Machining), allows the machine operator to retract the tool along its machining direction when pressing a button and even move the tool in parallel to the tilted working plane.

On a 3-axis machining process, it is relatively easy to move the Z-axis only to free the tool; on a 5-axis machining process, a smart solution such as the 3D Manual Feed function greatly helps the machine operator.

### Benefits

- Manual intervention options in the event of emergencies, for example, after a tool break
- Simplifies operation of 5-axis machine manual movements relative to the machining plane or tool direction vector
- Perform setup and adjustments of part location on machines with rotary axes that tilt the workpiece or rotate the tooling axis vector
- Safely remove the tool from a part when operating in 5-axis mode
- Broken tool recovery
- Manually move a tool normal to the feature coordinate system
- Ability to retract a tool on a vector
- Consolidated package of 5-axis features related to Manual Handle Feed usage

### Ordering Information

Specification	Description
A02B-0323-S679	30i-B 3-Dimensional Manual Feed
A02B-0326-S679	31i-B5 3-Dimensional Manual Feed
A02B-0327-S679	31i-B 3-Dimensional Manual Feed
A02B-0328-S679	32i-B 3-Dimensional Manual Feed
A02B-0340-S679	0i-MF 3-Dimensional Manual Feed

#### Notice

Certain functions may require additional hardware, different CPU type or additional memory capacity or may cause compatibility issue with other functions. In case of doubt, contact your FANUC sales representative for additional information and support.

The information given in the FANUC manuals or original manufacturer documentation shall prevail. Technical data is subject to change without prior notice. No part of this document may be reproduced in any form. All rights reserved. © FANUC 2017

# 135

## Operation

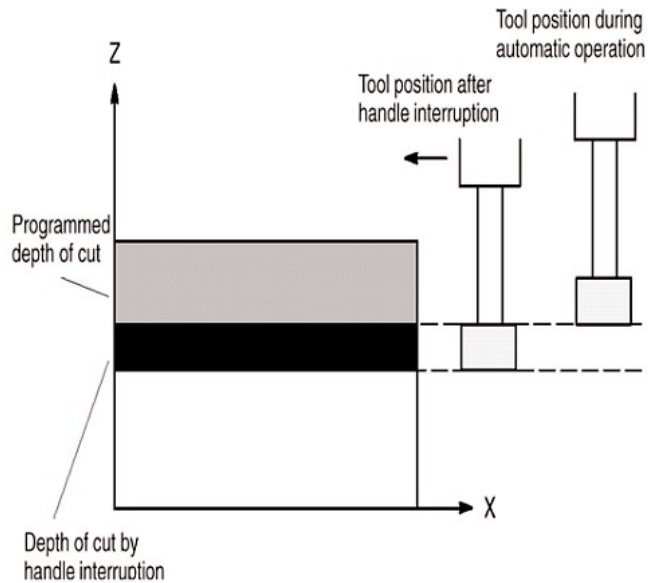

## Handle Interruption

### Features

With the Handle Interrupt function, it is possible with a handwheel to move any axis while cycle start is active.

When doing so, the handwheel movement is added to any programmed axis motion.

This function is a basic function in FANUC Series 0i-F.

### Benefits

- Allows the operator to adjust the axis position in automatic mode, without changing the part program
- Easy control of depth of cuts by operator using hand wheel
- Reduces set up
- Allows improvement by simple testing

### Ordering Information

Specification	Description
A02B-0323-J837	30i-B Handle Interruption
A02B-0326-J837	31i-B5 Handle Interruption
A02B-0327-J837	31i-B Handle Interruption
A02B-0328-J837	32i-B Handle Interruption

#### Notice

Certain functions may require additional hardware, different CPU type or additional memory capacity or may cause compatibility issue with other functions. In case of doubt, contact your FANUC sales representative for additional information and support.

The information given in the FANUC manuals or original manufacturer documentation shall prevail. Technical data is subject to change without prior notice. No part of this document may be reproduced in any form. All rights reserved. © FANUC 2017



# 136

## Operation

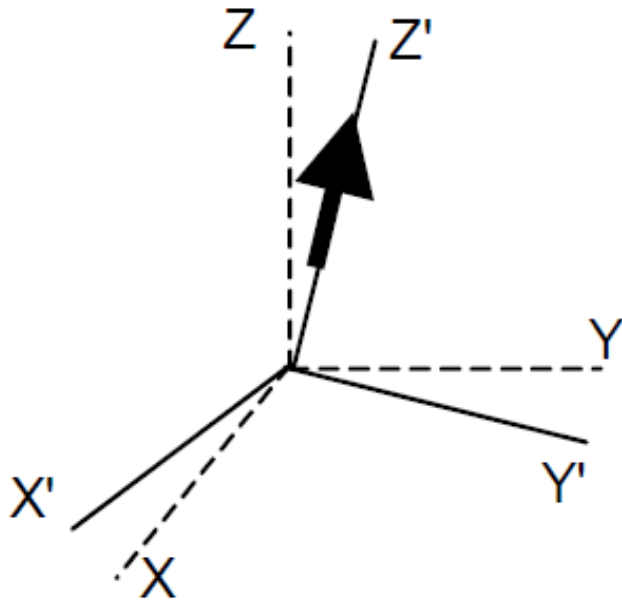

# Manual Interruption of 3D Coordinate Conversion

## Features

By this function, it is possible to use a handwheel to move axes in automatic operation mode if the 3-dimensional coordinate conversion function is active. The handwheel motion is added to the programmed axes motion. The handwheel motion is performed in the direction of the selected axis in the rotated coordinate system.

## Benefits

- Allows the operator to adjust the axes positions in automatic mode without changing the program
- Reduces set-up time

## Ordering Information

Specification	Description
A02B-0323-S949	30i-B Manual Interruption of 3-D Coordinate System Conversion
A02B-0326-S949	31i-B5 Manual Interruption of 3-D Coordinate System Conversion
A02B-0327-S949	31i-B Manual Interruption of 3-D Coordinate System Conversion
A02B-0328-S949	32i-B Manual Interruption of 3-D Coordinate System Conversion
A02B-0339-S949	0i-TF Manual Interruption of 3-D Coordinate System Conversion
A02B-0340-S949	0i-MF Manual Interruption of 3-D Coordinate System Conversion

### Notice

Certain functions may require additional hardware, different CPU type or additional memory capacity or may cause compatibility issue with other functions. In case of doubt, contact your FANUC sales representative for additional information and support.

The information given in the FANUC manuals or original manufacturer documentation shall prevail. Technical data is subject to change without prior notice. No part of this document may be reproduced in any form. All rights reserved. © FANUC 2017

# 137

## Operation

# Manual Handle Interface for BETA i Series with I/O-Link

## Features

The Manual Handle Interface for BETA i series amplifier function controls manual handle feed for BETA i servo amplifiers connected through I/O Link to the CNC with a manual pulse generator connected on the CNC directly (instead of on the amplifier).

Pulses from manual pulse generator are transferred from the CNC side to the BETA i servo amplifier through the I/O network. Furthermore, this function can control the magnification of pulses by changing the parameter.

## Note

Power Mate CNC manager (-J674) is required.

## Benefits

- Simplifies manual operator intervention
- Reduce wiring for remote servo amplifiers
- Improves machining productivity

## Ordering Information

Specification	Description
A02B-0323-S722	30i-B BETA I/O LINK Manual Handle Interface (Peripheral Control)
A02B-0326-S722	31i-B5 BETA I/O LINK Manual Handle Interface (Peripheral Control)
A02B-0327-S722	31i-B BETA I/O LINK Manual Handle Interface (Peripheral Control)
A02B-0328-S722	32i-B BETA I/O LINK Manual Handle Interface (Peripheral Control)
A02B-0333-S722	35i-B BETA I/O LINK Manual Handle Interface (Peripheral Control)
A02B-0334-S722	PM i-A BETA I/O LINK Manual Handle Interface (Peripheral Control)
A02B-0339-S722	0i-TF Manual Handle Interface with I/O LINK BETA Servo
A02B-0340-S722	0i-MF Manual Handle Interface with I/O LINK BETA Servo

### Notice

Certain functions may require additional hardware, different CPU type or additional memory capacity or may cause compatibility issue with other functions. In case of doubt, contact your FANUC sales representative for additional information and support.

The information given in the FANUC manuals or original manufacturer documentation shall prevail. Technical data is subject to change without prior notice. No part of this document may be reproduced in any form. All rights reserved. © FANUC 2017

# 138

## Operation

# Manual Numerical Command

## Features

The Manual Numerical Command function allows the operator to execute data programmed through the MDI in jog mode. Whenever the system is ready for jog feed, a manual numerical command can be executed.

The following eight functions are supported:

1. Positioning (G00)
2. Linear interpolation (G01)
3. Automatic reference position return (G28)
4. 2nd/3rd/4th reference position return (G30)
5. M codes (miscellaneous functions)
6. S codes (spindle speed functions)
7. T codes (tool functions)
8. B codes (second auxiliary functions)

## Benefits

- Simplifies operator intervention
- Simplifies programming
- Improves machining productivity

## Ordering Information

Specification	Description
A02B-0323-J667	30i-B Manual Numerical Command
A02B-0326-J667	31i-B5 Manual Numerical Command
A02B-0327-J667	31i-B Manual Numerical Command
A02B-0328-J667	32i-B Manual Numerical Command
A02B-0339-J667	0i-TF Manual Numerical Command
A02B-0340-J667	0i-MF Manual Numerical Command

### Notice

Certain functions may require additional hardware, different CPU type or additional memory capacity or may cause compatibility issue with other functions. In case of doubt, contact your FANUC sales representative for additional information and support.

The information given in the FANUC manuals or original manufacturer documentation shall prevail. Technical data is subject to change without prior notice. No part of this document may be reproduced in any form. All rights reserved. © FANUC 2017

# 139

## Operation

# Reference Position Signal Output

## Features

The Reference Position Signal Output function provides the capability for the CNC to output a signal to the PMC after the establishment of the reference position on each axis and when the coordinates in the machine coordinate system match the reference position.

In addition, if the coordinates in the machine coordinate system matches a second reference position, the function outputs an additional signal to the PMC.

## Benefits

- Simplifies operator intervention
- Simplifies programming
- Improves machining productivity

## Ordering Information

Specification	Description
A02B-0323-S629	30i-B Reference position signal output
A02B-0326-S629	31i-B5 Reference Position Signal Output
A02B-0327-S629	31i-B Reference Position Signal Output
A02B-0328-S629	32i-B Reference Position Signal Output
A02B-0339-S629	0i-TF Reference Position Signal Output
A02B-0340-S629	0i-MF Reference Position Signal Output

### Notice

Certain functions may require additional hardware, different CPU type or additional memory capacity or may cause compatibility issue with other functions. In case of doubt, contact your FANUC sales representative for additional information and support.

The information given in the FANUC manuals or original manufacturer documentation shall prevail. Technical data is subject to change without prior notice. No part of this document may be reproduced in any form. All rights reserved. © FANUC 2017

# 140

## Operation

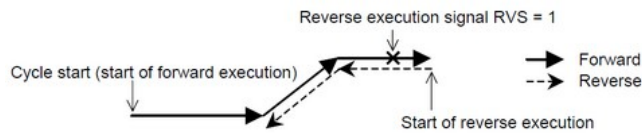

## Retrace

### Features

The Retrace Function is available for milling operations only. It provides a comfortable way for the operator to move the tool in the reverse direction, during automatic operation, using the REVERSE switch.

This causes the CNC to retrace (i.e. reverse) the programmed path. The tool may subsequently be moved forward again, along the programmed path, to resume cutting.

### Benefits

- Convenient mechanism for backing the tool up from the current position, should the need arise, then returning to that position and resuming cutting.

### Ordering Information

Specification	Description
A02B-0323-J730	30i-B Retrace Function
A02B-0326-J730	31i-B5 Retrace Function
A02B-0327-J730	31i-B Retrace Function
A02B-0328-J730	32i-B Retrace Function
A02B-0340-J730	0i-MF Retrace Function

#### Notice

Certain functions may require additional hardware, different CPU type or additional memory capacity or may cause compatibility issue with other functions. In case of doubt, contact your FANUC sales representative for additional information and support.

The information given in the FANUC manuals or original manufacturer documentation shall prevail. Technical data is subject to change without prior notice. No part of this document may be reproduced in any form. All rights reserved. © FANUC 2017

# 141

## Operation

# Manual Handle Retrace

## Features

The Manual Handle Retrace function allows, during automatic operation, that the operator debugs execution of the part program by simple and intuitive manipulation of the Manual Pulse Generator (MPG).

Using forward and reverse directions, the operator can isolate the problem area and observe the tool path; it can be done at a speed appropriate for accurate observation.

## Benefits

- Operating the machine via the MPG allows the operator to check for errors in the part program.
- The operator controls the speed of program execution via simple and intuitive manipulation of the MPG hand-wheel and multiplier switch, and controls direction of execution via the MPG polarity switch. This allows for close observation of the path at a suitable speed.
- Manual Handle Retrace may be used to isolate and check out a specific portion of the part program: it is not required that the entire program be subjected to Manual Handle Retrace operation.
- Manual Handle Retrace allows the operator to halt execution close to a problem spot in his program. It is not necessary to stop at a precise block, since forward and reverse execution is available to zone in on the problem.

## Ordering Information

Specification	Description
A02B-0323-J998	30i-B Manual Handle Retrace
A02B-0326-J998	31i-B5 Manual Handle Retrace
A02B-0327-J998	31i-B Manual Handle Retrace
A02B-0328-J998	32i-B Manual Handle Retrace
A02B-0339-J998	0i-TF Manual Handle Retrace
A02B-0340-J998	0i-MF Manual Handle Retrace

### Notice

Certain functions may require additional hardware, different CPU type or additional memory capacity or may cause compatibility issue with other functions. In case of doubt, contact your FANUC sales representative for additional information and support.

The information given in the FANUC manuals or original manufacturer documentation shall prevail. Technical data is subject to change without prior notice. No part of this document may be reproduced in any form. All rights reserved. © FANUC 2017

# 142

## Operation

# Manual Handle Retrace for Multi-Path

## Features

In the Manual Handle Retrace for Multi-Path function, when the operation of re-forward movement is performed after backward movement, it is possible to adjust the timing of all path's movement to that of original forward movement.

In manual handle retrace function, when backward movement is prohibited to in a path, and other paths continue the backward movement, if re-forward movement is performed later, all paths start the re-forward movement immediately, therefore the timing of block movement in each path is different from original forward movement.

In this function, when re-forward movement is performed after backward movement, the path in which backward movement is prohibited doesn't start re-forward movement immediately. After other paths reach the position where the backward movement is prohibited, the re-forward movement of this path is performed. Therefore, in multi path, block movement of each path in re-forward movement can be performed at the same timing in forward movement.

## Benefits

- Provides the Manual Handle Retrace benefits to a complex Multi-Path system
- Operating the machine via the MPG allows the operator to check for errors in the part program.
- The operator controls the speed of program execution via simple and intuitive manipulation of the MPG hand-wheel and multiplier switch, and controls direction of execution via the MPG polarity switch. This allows for close observation of the path at a suitable speed.
- Manual Handle Retrace may be used to isolate and check out a specific portion of the part program: it is not required that the entire program be subjected to Manual Handle Retrace operation.
- Manual Handle Retrace allows the operator to halt execution close to a problem spot in his program. It is not necessary to stop at a precise block, since forward and reverse execution is available to zone in on the problem.

## Ordering Information

Specification	Description
A02B-0323-R606	30i-B Manual Handle Retrace Function for Multi-Path CNC
A02B-0326-R606	31i-B5 Manual Handle Retrace Function for Multi-Path CNC
A02B-0327-R606	31i-B Manual Handle Retrace Function for Multi-Path CNC
A02B-0328-R606	32i-B Manual Handle Retrace Function for Multi-Path CNC
A02B-0339-R606	0i-TF Manual Handle Retrace Function for Multi-Path
A02B-0340-R606	0i-MF Manual Handle Retrace Function for Multi-Path

### Notice

Certain functions may require additional hardware, different CPU type or additional memory capacity or may cause compatibility issue with other functions. In case of doubt, contact your FANUC sales representative for additional information and support.

The information given in the FANUC manuals or original manufacturer documentation shall prevail. Technical data is subject to change without prior notice. No part of this document may be reproduced in any form. All rights reserved. © FANUC 2017

# 143

## Operation

# Direction Change Movement in Auxiliary Function Output Block Function

## Features

With this function and in manual handle retrace mode, when movement command and auxiliary function (M,S,T,B-code) are commanded within the same block, the direction change movement can be evaluated within the PMC and appropriate action can be taken.

Parameter: it is possible to allow or prohibit direction change during manual handle retrace operation while setting the corresponding parameter accordingly.

Signal: in manual handle retrace, when both movement command and auxiliary function (M,S,T,B-code) are commanded in a block at a time, a signal notifies direction change of movement performed by the manual handle.

## Benefits

- Simplifies operator work and effectivity in manual / handle mode
- Improves machining productivity

## Ordering Information

Specification	Description
A02B-0323-S628	30i-B Direction Change Movement in Auxiliary Function Output Block Function
A02B-0326-S628	31i-B5 Direction Change Movement in Auxiliary Function Output Block Function
A02B-0327-S628	31i-B Direction Change Movement in Auxiliary Function Output Block Function
A02B-0328-S628	32i-B Direction Change Movement in Auxiliary Function Output Block Function
A02B-0339-S628	0i-TF Direction Change Movement in Auxiliary Function Output Block
A02B-0340-S628	0i-MF Direction Change Movement in Auxiliary Function Output Block

### Notice

Certain functions may require additional hardware, different CPU type or additional memory capacity or may cause compatibility issue with other functions. In case of doubt, contact your FANUC sales representative for additional information and support.

The information given in the FANUC manuals or original manufacturer documentation shall prevail. Technical data is subject to change without prior notice. No part of this document may be reproduced in any form. All rights reserved. © FANUC 2017



# 144

## Operation

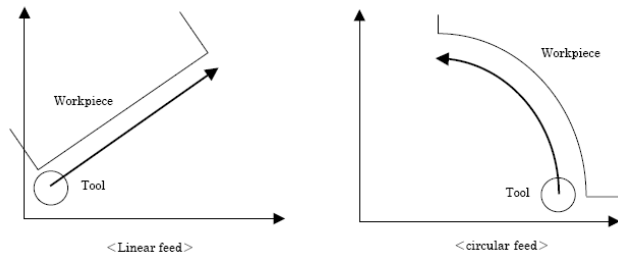

# Manual Linear/Circular Interpolation

## Features

In manual handle feed or jog feed, the following types of feed operations are enabled along with conventional single axis feed operation:

- Feed along a tilted straight line in the XY plane or YZ plane or ZX plane based on simultaneous 2-axis control (linear feed)
- Feed along a circle in the XY plane or YZ plane or ZX plane based on simultaneous 2-axis control (circular feed)

Note: when using the Manual Linear / Circular Interpolation function, the option 'Manual handle feed 1-unit' is required. When using 2nd or 3rd Manual handle, the option 'Manual handle feed 2/3-unit' or 'Manual handle feed 4/5-unit' is required. When using 4th or 5th Manual handle, the option 'Manual handle feed 4/5-unit' is required.

## Benefits

- Simplifies operator work and effectivity in manual / handle mode
- Improves machining productivity

## Ordering Information

Specification	Description
A02B-0323-J774	30i-B Manual Linear / Circular Interpolation
A02B-0326-J774	31i-B5 Manual Linear / Circular Interpolation
A02B-0327-J774	31i-B Manual Linear / Circular Interpolation
A02B-0328-J774	32i-B Manual Linear / Circular Interpolation
A02B-0339-J774	0i-TF Manual Linear / Circular Interpolation
A02B-0340-J774	0i-MF Manual Linear / Circular Interpolation

### Notice

Certain functions may require additional hardware, different CPU type or additional memory capacity or may cause compatibility issue with other functions. In case of doubt, contact your FANUC sales representative for additional information and support.

The information given in the FANUC manuals or original manufacturer documentation shall prevail. Technical data is subject to change without prior notice. No part of this document may be reproduced in any form. All rights reserved. © FANUC 2017

# 145

## Operation

## Reverse Motion Function for Restart

The machining can be restarted very easily by using this function after the machining stopped due to a reset, an emergency stop or a power failure.

The function consists of the following three features:

- When machining stops because of an interruption and the tool runs off the machining path, the function enables the tool to go back to the point on the machining path where the machining was interrupted.
- After the tool has returned to the interruption point, the CNC calls the interrupted program, searches for the interrupted block and holds there.
- After the recovery, maximum 100 blocks of the machining process can be reversed along the programming path, in order to retract the tool safely from the workpiece.

### Ordering Information

Specification	Description
A02B-0323-R529	30i-B Reverse Motion Function for Restart
A02B-0326-R529	31i-B5 Reverse Motion Function for Restart
A02B-0327-R529	31i-B Reverse Motion Function for Restart
A02B-0328-R529	32i-B Reverse Motion Function for Restart

#### Notice

Certain functions may require additional hardware, different CPU type or additional memory capacity or may cause compatibility issue with other functions. In case of doubt, contact your FANUC sales representative for additional information and support.

The information given in the FANUC manuals or original manufacturer documentation shall prevail. Technical data is subject to change without prior notice. No part of this document may be reproduced in any form. All rights reserved. © FANUC 2017

# 146

## Operation

# Active Block Cancel

---

## Features

The Active Block Cancel function is used to cancel the executing block by a signal from the PMC, and to stop.

The distance remaining is cleared, and the execution is restarted from the next block of canceled block by cycle start.

## Benefits

- Possibility to check the part program for a short time.
- Simplifies operator work
- Improves machining productivity

## Ordering Information

Specification	Description
A02B-0323-S627	30i-B Active Block Cancel
A02B-0326-S627	31i-B5 Active Block Cancel
A02B-0327-S627	31i-B Active Block Cancel
A02B-0328-S627	32i-B Active Block Cancel
A02B-0339-S627	0i-TF Active Block Cancel
A02B-0340-S627	0i-MF Active Block Cancel

### Notice

Certain functions may require additional hardware, different CPU type or additional memory capacity or may cause compatibility issue with other functions. In case of doubt, contact your FANUC sales representative for additional information and support.

The information given in the FANUC manuals or original manufacturer documentation shall prevail. Technical data is subject to change without prior notice. No part of this document may be reproduced in any form. All rights reserved. © FANUC 2017

# 147

## Operation

# High-Speed Program Check

## Features

The High Speed Program Check function provides the following features:

- The program format check and the stroke limit check are available without axes movements.
- The program check is executed with the maximum feedrate of CNC system and without the acceleration / deceleration regardless of the specified data.
- After the program check is completed, the reference position return is not necessary because the workpiece coordinate system preset is executed automatically at the end of the high speed program check mode.
- In case that the parameter PGR (No.3454#3) is set to "1", the data, which are changed during the high speed program check mode, are restored to the data at the start of the high speed program check mode when ending the high speed program check mode. By this, after ending the high speed program check mode, the automatic operation can be executed with the data before the start of the high speed program check mode.

## Benefits

- Possibility to accelerate the check of the programs
- Time saving

## Ordering Information

Specification	Description
A02B-0323-S880	30i-B High-Speed Program Check Function
A02B-0326-S880	31i-B5 High-Speed Program Check Function
A02B-0327-S880	31i-B High-Speed Program Check Function
A02B-0328-S880	32i-B High-Speed Program Check Function
A02B-0339-S880	0i-TF High-Speed Program Check
A02B-0340-S880	0i-MF High-Speed Program Check

### Notice

Certain functions may require additional hardware, different CPU type or additional memory capacity or may cause compatibility issue with other functions. In case of doubt, contact your FANUC sales representative for additional information and support.

The information given in the FANUC manuals or original manufacturer documentation shall prevail. Technical data is subject to change without prior notice. No part of this document may be reproduced in any form. All rights reserved. © FANUC 2017

# 148

## Operation

# Time Override Function for Dwell/Auxiliary Function

---

## Features

The Time Override Function for Dwell/Auxiliary Function applies override to the dwell and auxiliary (M/S/T/B) function in the range of 0% to 100% in steps of 1%.

If the override is applied to auxiliary (M/S/T/B) function, the next block is executed after a shortage of time. The actual processing time is considered to be 100%, and the shortage is calculated from the time.

## Benefits

- Simplifies the operation of the machine
- Improves machining productivity

## Ordering Information

Specification	Description
A02B-0323-R500	30i-B Dwell / Auxiliary Function Time Override Function
A02B-0326-R500	31i-B5 Dwell / Auxiliary Function Time Override Function
A02B-0327-R500	31i-B Dwell / Auxiliary Function Time Override Function
A02B-0328-R500	32i-B Dwell / Auxiliary Function Time Override Function
A02B-0339-R500	0i-TF Dwell/Aux. Function Time Override
A02B-0340-R500	0i-MF Dwell/Aux. Function Time Override

### Notice

Certain functions may require additional hardware, different CPU type or additional memory capacity or may cause compatibility issue with other functions. In case of doubt, contact your FANUC sales representative for additional information and support.

The information given in the FANUC manuals or original manufacturer documentation shall prevail. Technical data is subject to change without prior notice. No part of this document may be reproduced in any form. All rights reserved. © FANUC 2017

# 149

## Operation

# Pulse Superimposed Function

## Features

The Pulse Superimposed Function enables pulse superimposed control in cutting mode that have been specified by the PMC in automatic operation mode (MDI operation, DNC operation, and memory operation) and in memory edit mode.

The maximum number of superimposed axes at the same time is two on each path (twice the number of paths in the entire system).

This function requires the following option:

- Manual handle interrupt
- Manual handle feed, 1 unit
- Manual handle feed, 2/3-units
- (or manual handle feed, 4/5-units)

## Benefits

- Simplifies the operation of the machine
- Improves machining productivity

## Ordering Information

Specification	Description
A02B-0323-R559	30i-B Pulse Superimposed Function
A02B-0326-R559	31i-B5 Pulse Superimposed Function
A02B-0327-R559	31i-B Pulse Superimposed Function
A02B-0328-R559	32i-B Pulse Superimposed Function

### Notice

Certain functions may require additional hardware, different CPU type or additional memory capacity or may cause compatibility issue with other functions. In case of doubt, contact your FANUC sales representative for additional information and support.

The information given in the FANUC manuals or original manufacturer documentation shall prevail. Technical data is subject to change without prior notice. No part of this document may be reproduced in any form. All rights reserved. © FANUC 2017

# 150

## Operation

# MDI Reset Key Invalidation

If the reset key on MDI is pushed while executing the NC program, the reset is ignored and the execution of the NC program is not stopped.

## Ordering Information

Specification	Description
A02B-0323-R549	30i-B MDI Reset Key Invalidation Function
A02B-0326-R549	31i-B5 MDI Reset Key Invalidation Function
A02B-0327-R549	31i-B MDI Reset Key Invalidation Function
A02B-0328-R549	32i-B MDI Reset Key Invalidation Function
A02B-0333-R549	35i-B MDI Reset Key Invalidation Function
A02B-0334-R549	PM i-A MDI Reset Key Invalidation Function

### Notice

Certain functions may require additional hardware, different CPU type or additional memory capacity or may cause compatibility issue with other functions. In case of doubt, contact your FANUC sales representative for additional information and support.

The information given in the FANUC manuals or original manufacturer documentation shall prevail. Technical data is subject to change without prior notice. No part of this document may be reproduced in any form. All rights reserved. © FANUC 2017

# 151

## Functions

## Interpolation Functions

---

This section of the catalogue contains the functions related to the interpolation capabilities and functions of the CNC system.

Interpolation functions control how the CNC will move the axes. Simple positioning, linear and circular interpolation are standard features of the controllers. Other forms of interpolation are optional and depend on the purpose of the machine tool. They can ease drastically the programming of complex geometric shapes, as well as optimize the part programs size and improve the accuracy of the machine.

Some of the interpolation functions detailed in the catalogue:

- Exponential Interpolation
- Polar Coordinate Interpolation
- Cylindrical Interpolation
- Helical Interpolation
- Involute Interpolation
- Hypothetical Axes Interpolation
- Conical/Spiral Interpolation
- Smooth Interpolation
- Nano Smoothing
- Thread cutting, synchronous cutting, complex threading
- NURBS Interpolation
- 3 Dimensional Circular Interpolation
- High-speed cutting
- Path Table Operation
- High-speed binary program operation
- Etc.

### Notice

Certain functions may require additional hardware, different CPU type or additional memory capacity or may cause compatibility issue with other functions. In case of doubt, contact your FANUC sales representative for additional information and support.

The information given in the FANUC manuals or original manufacturer documentation shall prevail. Technical data is subject to change without prior notice. No part of this document may be reproduced in any form. All rights reserved. © FANUC 2017



# 152

## Interpolation Functions

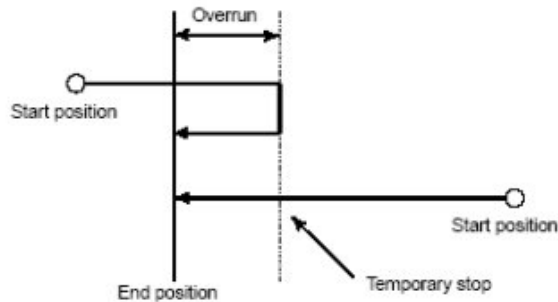

## Single Direction Positioning

### Features

When using the Single Direction Positioning function, the CNC automatically approaches specific locations always from the same direction.

Accurate positioning without backlash can be performed and final positioning from one direction is possible as well.

This function is a basic function in FANUC Series 0i-MF.

### Benefits

- Minimize backlash error by using unidirectional positioning
- Improves accuracy in bolt hole patterns with minimized backlash error

### Ordering Information

Specification	Description
A02B-0323-J812	30i-B Single Direction Positioning
A02B-0326-J812	31i-B5 Single Direction Positioning
A02B-0327-J812	31i-B Single Direction Positioning
A02B-0328-J812	32i-B Single Direction Positioning
A02B-0333-J812	35i-B Single Direction Positioning

#### Notice

Certain functions may require additional hardware, different CPU type or additional memory capacity or may cause compatibility issue with other functions. In case of doubt, contact your FANUC sales representative for additional information and support.

The information given in the FANUC manuals or original manufacturer documentation shall prevail. Technical data is subject to change without prior notice. No part of this document may be reproduced in any form. All rights reserved. © FANUC 2017

# 153

## Interpolation Functions

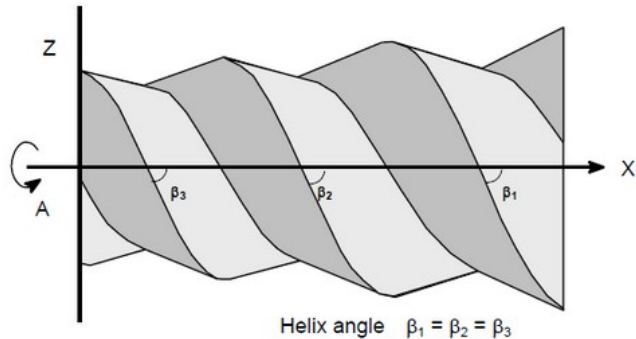

## Exponential Interpolation

### Features

The Exponential Interpolation function is used to coordinate linear and rotary axis movement.

Exponential interpolation exponentially changes the rotation of a workpiece with respect to movement on the rotary axis. Furthermore, exponential interpolation performs linear interpolation with respect to another axis.

This enables tapered groove machining with a constant helix angle (constant helix taper machining). This function is best suited for grooving and grinding tools such as taper end mills.

### Benefits

- Adds special interpolation type to the CNC
- Provides interpolation specialized for grooving and grinding tools
- Improves overall machining productivity

### Ordering Information

Specification	Description
A02B-0323-J711	30i-B Exponential Interpolation
A02B-0326-J711	31i-B5 Exponential Interpolation
A02B-0327-J711	31i-B Exponential Interpolation

### Notice

Certain functions may require additional hardware, different CPU type or additional memory capacity or may cause compatibility issue with other functions. In case of doubt, contact your FANUC sales representative for additional information and support.

The information given in the FANUC manuals or original manufacturer documentation shall prevail. Technical data is subject to change without prior notice. No part of this document may be reproduced in any form. All rights reserved. © FANUC 2017

# 154

## Interpolation Functions

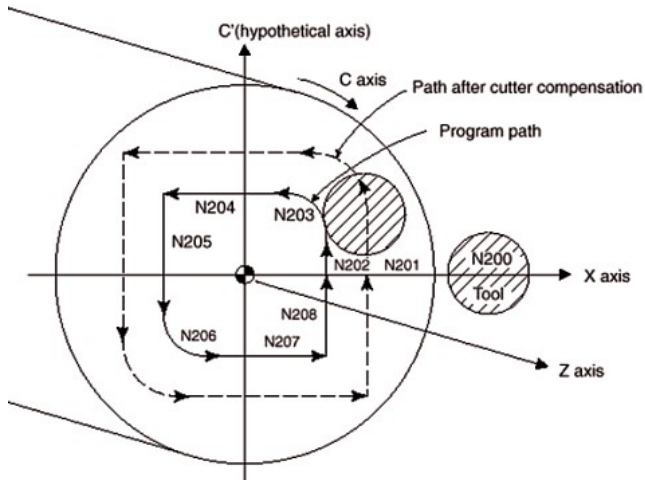

# Polar Coordinate Interpolation

## Features

The Polar Coordinate Interpolation function allows a designated pair of axes (one rotary and one linear) to be programmed like two linear axes.

The function converts a command programmed in the Cartesian coordinate system to the movement of a linear axis (movement of a tool) and the movement of a rotary axis (rotation of a workpiece).

Examples of use include cutting grooves in face side of rotary workpiece and grinding a camshaft.

This function is a basic function in FANUC Series 0i-TF.

## Benefits

- Simplifies programming when a linear movement and a rotational movement have to be coordinated.

## Ordering Information

Specification	Description
A02B-0323-J815	30i-B Polar Coordinate Interpolation
A02B-0326-J815	31i-B5 Polar Coordinate Interpolation
A02B-0327-J815	31i-B Polar Coordinate Interpolation
A02B-0328-J815	32i-B Polar Coordinate Interpolation
A02B-0333-J815	35i-B Polar Coordinate Interpolation
A02B-0334-J815	PM i-A Polar Coordinate Interpolation

### Notice

Certain functions may require additional hardware, different CPU type or additional memory capacity or may cause compatibility issue with other functions. In case of doubt, contact your FANUC sales representative for additional information and support.

The information given in the FANUC manuals or original manufacturer documentation shall prevail. Technical data is subject to change without prior notice. No part of this document may be reproduced in any form. All rights reserved. © FANUC 2017

# 155

## Interpolation Functions

### Example of a cylindrical interpolation programs

```
O0001 (CYLINDRICAL INTERPOLATION);  
N01 G00 G90 Z100.0 C0 ;  
N02 G01 G91 G18 Z0 C0 ;  
N03 G07.1 C57.299 ;  
N04 G90 G01 G42 Z120.0 D01 F250 ;  
N05 C30.0 ;  
N06 G03 Z90.0 C60.0 R30.0 ;  
N07 G01 Z70.0 ;  
N08 G02 Z60.0 C70.0 R10.0 ;  
N09 G01 C150.0 ;  
N10 G02 Z70.0 C190.0 R75.0 ;  
N11 G01 Z110.0 C230.0 ;  
N12 G03 Z120.0 C270.0 R75.0 ;  
N13 G01 C360.0 ;  
N14 G40 Z100.0 ;  
N15 G07.1 C0 ;  
N16 M30 ;
```

Note) Sample program where the C axis is parallel to the X-axis.

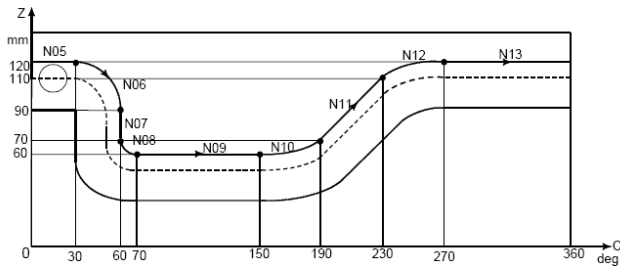
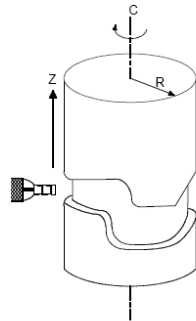

# Cylindrical Interpolation

## Features

The Cylindrical Interpolation function allows the programmer to program a shape on the surface of a cylinder, using linear and circular interpolation commands.

The programmer can visualize the surface of the cylinder being worked as if it had been rolled out on a flat plane.

This function is a basic function in FANUC Series 0i-MF and 0i-TF.

## Benefits

- Simplifies programming for machining the curved surface of a cylinder.
- Programs such as those for grooving cylindrical cams can be easily created.

## Ordering Information

Specification	Description
A02B-0323-J816	30i-B Cylindrical Interpolation
A02B-0326-J816	31i-B5 Cylindrical Interpolation
A02B-0327-J816	31i-B Cylindrical Interpolation
A02B-0328-J816	32i-B Cylindrical Interpolation

### Notice

Certain functions may require additional hardware, different CPU type or additional memory capacity or may cause compatibility issue with other functions. In case of doubt, contact your FANUC sales representative for additional information and support.

The information given in the FANUC manuals or original manufacturer documentation shall prevail. Technical data is subject to change without prior notice. No part of this document may be reproduced in any form. All rights reserved. © FANUC 2017

# 156

## Interpolation Functions

# Cylindrical Interpolation by Plane Distance Command

---

## Features

Normally, a program command for the rotary axis in the cylindrical interpolation was given by rotary angle of the rotary axis.

The Cylindrical Interpolation by Plane Distance Command function enables a command for the rotary axis in the cylindrical interpolation by the cylindrical plane distance according to a parameter setting.

## Benefits

- Provide an additional method of programming the cylindrical interpolation
- Increases the programming flexibility

## Ordering Information

Specification	Description
A02B-0323-R578	30i-B Cylindrical Interpolation by Plane Distance Command
A02B-0326-R578	31i-B5 Cylindrical Interpolation by Plane Distance Command
A02B-0327-R578	31i-B Cylindrical Interpolation by Plane Distance Command
A02B-0328-R578	32i-B Cylindrical Interpolation by Plane Distance Command
A02B-0339-R578	0i-TF Cylindrical Interpolation by Plane Distance Command
A02B-0340-R578	0i-MF Cylindrical Interpolation by Plane Distance Command

### Notice

Certain functions may require additional hardware, different CPU type or additional memory capacity or may cause compatibility issue with other functions. In case of doubt, contact your FANUC sales representative for additional information and support.

The information given in the FANUC manuals or original manufacturer documentation shall prevail. Technical data is subject to change without prior notice. No part of this document may be reproduced in any form. All rights reserved. © FANUC 2017

# 157

## Interpolation Functions

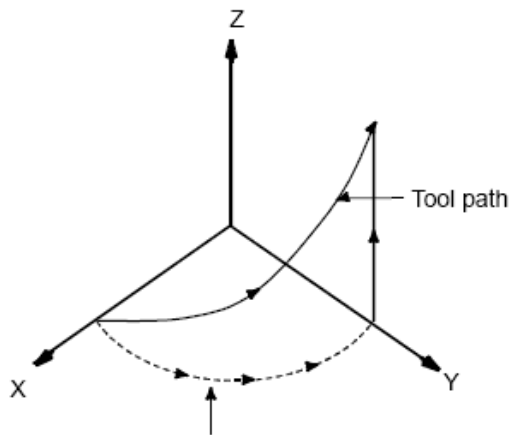

The feedrate along the circumference of two circular interpolated axes is the specified feedrate.

## Helical Interpolation

### Features

Helical Interpolation permits the programmer to command a move in which up to two axes are moved in a linear fashion at the same time as the basic two axes that are performing circular interpolation. This results in a helical cut.

This function is a basic function in FANUC Series 0i-MF and 0i-PF.

### Benefits

- Provides a simple way to program helical cuts
- Increases the programming flexibility of the CNC

### Ordering Information

Specification	Description
A02B-0323-J819	30i-B Helical Interpolation
A02B-0326-J819	31i-B5 Helical Interpolation
A02B-0327-J819	31i-B Helical Interpolation
A02B-0328-J819	32i-B Helical Interpolation
A02B-0333-J819	35i-B Helical Interpolation
A02B-0334-J819	PM i-A Helical Interpolation
A02B-0339-J819	0i-TF Helical Interpolation

#### Notice

Certain functions may require additional hardware, different CPU type or additional memory capacity or may cause compatibility issue with other functions. In case of doubt, contact your FANUC sales representative for additional information and support.

The information given in the FANUC manuals or original manufacturer documentation shall prevail. Technical data is subject to change without prior notice. No part of this document may be reproduced in any form. All rights reserved. © FANUC 2017

# 158

## Interpolation Functions

### Helical Interpolation B

---

#### Features

Helical Interpolation B permits the programmer to command a move in which up to four axes are moved in a linear fashion at the same time as the basic two axes that are performing circular interpolation.

#### Benefits

- Provides additional methods to realize advanced helical cuts
- Increases the programming flexibility of the CNC

#### Ordering Information

Specification	Description
A02B-0323-J655	30i-B Helical Interpolation B

#### Notice

Certain functions may require additional hardware, different CPU type or additional memory capacity or may cause compatibility issue with other functions. In case of doubt, contact your FANUC sales representative for additional information and support.

The information given in the FANUC manuals or original manufacturer documentation shall prevail. Technical data is subject to change without prior notice. No part of this document may be reproduced in any form. All rights reserved. © FANUC 2017

# 159

## Interpolation Functions

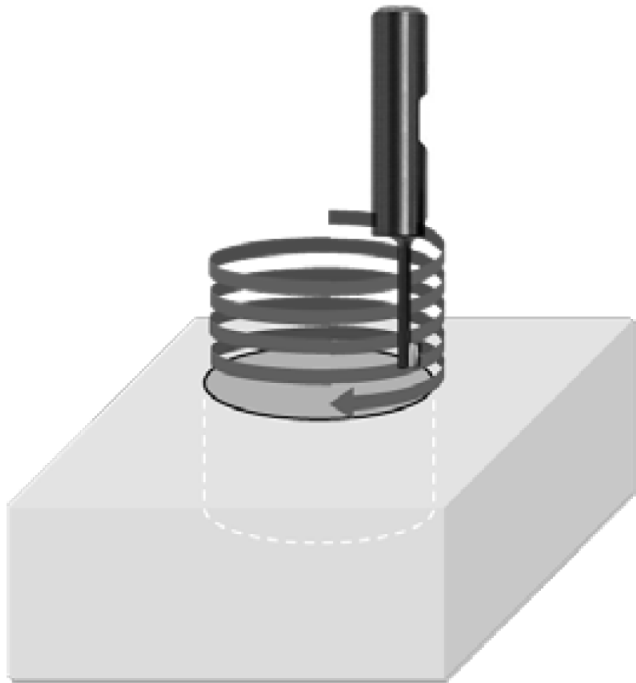

### Notice

Certain functions may require additional hardware, different CPU type or additional memory capacity or may cause compatibility issue with other functions. In case of doubt, contact your FANUC sales representative for additional information and support.

The information given in the FANUC manuals or original manufacturer documentation shall prevail. Technical data is subject to change without prior notice. No part of this document may be reproduced in any form. All rights reserved. © FANUC 2017

## Learning Helical Interpolation

### Features

Learning Helical Interpolation replaces boring machining with milling machining. High-speed and high-precision machining are realized by using Servo Learning Control. Both delays of the servo system and negative effects of periodic disturbance are minimized. Learning Helical Interpolation in combination with Servo Learning Control reduce the quadrant protrusions which occur when milling a hole with a helical motion, leading to higher precision.

### Benefits

- Reduce boring tools and minimize the amount of tool changes

### Ordering Information

Specification	Description
A02B-0323-R387	30i-B Learning Helical Interpolation
A02B-0326-R387	31i-B5 Learning Helical Interpolation
A02B-0327-R387	31i-B Learning Helical Interpolation
A02B-0328-R387	32i-B Learning Helical Interpolation



# 160

## Interpolation Functions

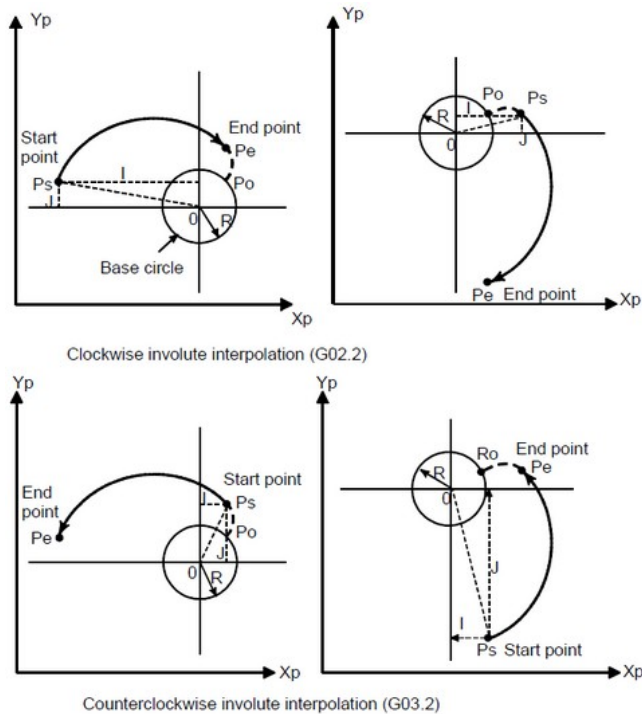

### Notice

Certain functions may require additional hardware, different CPU type or additional memory capacity or may cause compatibility issue with other functions. In case of doubt, contact your FANUC sales representative for additional information and support.

The information given in the FANUC manuals or original manufacturer documentation shall prevail. Technical data is subject to change without prior notice. No part of this document may be reproduced in any form. All rights reserved. © FANUC 2017

# Involute Interpolation

## Features

The Involute Interpolation function performs the machining of complex involute curves. Involute interpolation eliminates the need for approximating an involute curve with minute segments or arcs, and continuous pulse distribution is ensured even in high-speed operation of small blocks.

Accordingly, high-speed operation can be performed smoothly. Furthermore, machining programs can be created easily and efficiently, reducing the required length of program. Involute interpolation is useful for tool grinding.

The Helical Involute Interpolation function performs on two axes involute interpolation and on up to four other axes linear interpolation simultaneously.

When using only "Helical Involute Interpolation (S853)", this function performs two axes involute interpolation and up to two other axes linear interpolation simultaneously.

To enable the function to perform two axes involute interpolation and more than three other axes linear interpolation simultaneously, Helical Interpolation B (J655) option is required.

## Benefits

- Adds special interpolation type to the CNC
- Simplifies programming
- Improves overall machining productivity

## Ordering Information

Specification	Description
A02B-0323-J710	30i-B Involute Interpolation
A02B-0323-S853	30i-B Helical Involute Interpolation
A02B-0326-J710	31i-B5 Involute Interpolation
A02B-0326-S853	31i-B5 Helical Involute Interpolation
A02B-0327-J710	31i-B Involute Interpolation
A02B-0327-S853	31i-B Helical Involute Interpolation

# 161

## Interpolation Functions

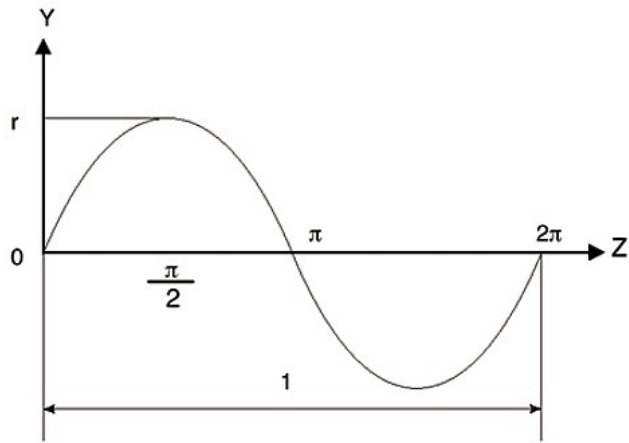

## Hypothetical Axes Interpolation

### Features

In helical interpolation when one of the circular interpolation axes is defined as a hypothetical axis then the tool path follows a sinusoidal path.

The Hypothetical Interpolation function is used for threading with a fractional lead. The axis to be set as the hypothetical axis is specified with G07.

### Benefits

- Adds special interpolation type to the CNC
- Simplifies programming
- Improves overall machining productivity

### Ordering Information

Specification	Description
A02B-0323-J652	30i-B Hypothetical Axes Interpolation
A02B-0326-J652	31i-B5 Hypothetical Axes Interpolation
A02B-0327-J652	31i-B Hypothetical Axes Interpolation

#### Notice

Certain functions may require additional hardware, different CPU type or additional memory capacity or may cause compatibility issue with other functions. In case of doubt, contact your FANUC sales representative for additional information and support.

The information given in the FANUC manuals or original manufacturer documentation shall prevail. Technical data is subject to change without prior notice. No part of this document may be reproduced in any form. All rights reserved. © FANUC 2017

# 162

## Interpolation Functions

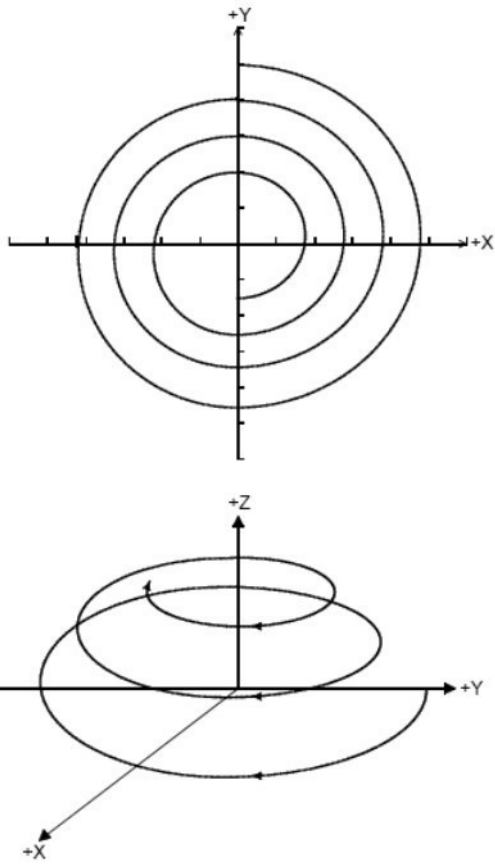

### Notice

Certain functions may require additional hardware, different CPU type or additional memory capacity or may cause compatibility issue with other functions. In case of doubt, contact your FANUC sales representative for additional information and support.

The information given in the FANUC manuals or original manufacturer documentation shall prevail. Technical data is subject to change without prior notice. No part of this document may be reproduced in any form. All rights reserved. © FANUC 2017

# Conical/Spiral Interpolation

## Features

The Conical/Spiral Interpolation function allows the CNC programmer to command, in a single block, a spiral move in a plane (two axes) or a conical move in three dimensions.

## Benefits

- Simple command block for spiral interpolation.
- Simple command block for conical interpolation.
- Common command structure for conical/spiral interpolation.

## Ordering Information

Specification	Description
A02B-0323-J780	30i-B Conical / Spiral Interpolation
A02B-0326-J780	31i-B5 Conical / Spiral Interpolation
A02B-0327-J780	31i-B Conical / Spiral Interpolation
A02B-0328-J780	32i-B Conical / Spiral Interpolation

# 163

## Interpolation Functions

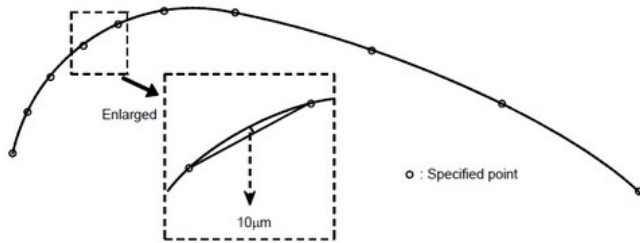

## Smooth Interpolation

### Features

The Smooth Interpolation function can be used to enhance the surface finish of the part being machined, such as die cutting, where the part program is typically large and consists of many small moves. The CNC automatically determines when to select one of two types of machining:

- For those portions where the accuracy of the figure is critical, such as at corners, machining will be performed exactly as specified by the program command.
- For those portions having a large radius of curvature, where a smooth figure is desired, points along the machining path will be interpolated with a smooth curve, calculated from the polygonal lines specified in successive program commands.

### Benefits

- Smooth surface finish, where dwell marks might otherwise have been a problem.
- Simple programming, with the CNC automatically determining when to apply smooth interpolation and when to ignore it.
- High-speed, high-precision machining can be performed.

### Ordering Information

Specification	Description
A02B-0323-J777	30i-B Smooth Interpolation
A02B-0326-J777	31i-B5 Smooth Interpolation
A02B-0327-J777	31i-B Smooth Interpolation

#### Notice

Certain functions may require additional hardware, different CPU type or additional memory capacity or may cause compatibility issue with other functions. In case of doubt, contact your FANUC sales representative for additional information and support.

The information given in the FANUC manuals or original manufacturer documentation shall prevail. Technical data is subject to change without prior notice. No part of this document may be reproduced in any form. All rights reserved. © FANUC 2017

# 164

## Interpolation Functions

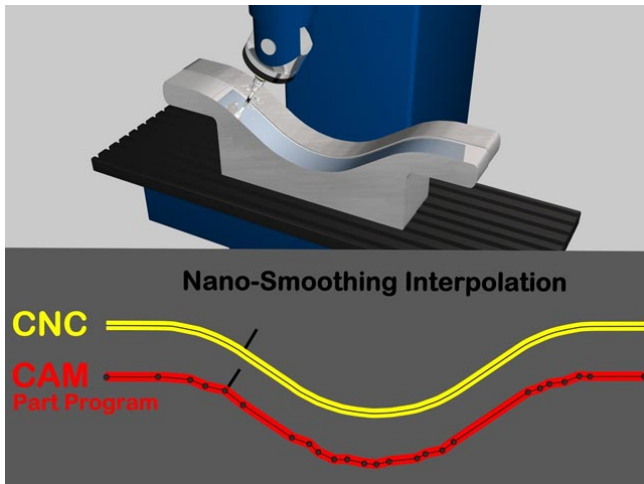

## Nano Smoothing

### Features

The Nano Smoothing function allows linear segmented programs developed either for 3-axis or 5-axis machines to be automatically converted into continuous free-forms using the CNCs inbuilt NURBS technology. When a desired, sculptured surface is approximated by minute segments, the nano smoothing function generates a smooth curve inferred from the programmed segments and performs the necessary interpolation.

The conventional Nano Smoothing function (S687) is limited to the three basic axes [X, Y, and Z] whereas the Nano Smoothing II function (R512), former Nano Smoothing for 5-Axis Machining, does additionally consider two rotary axes.

### Benefits

- Exceptional surface finish, better part quality
- Extremely "Fluid" motion, less tool wear
- Less requirement to process later the cut surface with grinding or polishing
- Significant increase of the machine productivity

### Ordering Information

Specification	Description
A02B-0323-R512	30i-B Nano Smoothing II
A02B-0323-S687	30i-B Nano Smoothing
A02B-0326-R512	31i-B5 Nano Smoothing II
A02B-0326-S687	31i-B5 Nano Smoothing
A02B-0327-S687	31i-B Nano Smoothing
A02B-0328-S687	32i-B Nano Smoothing
A02B-0340-S687	0i-MF Nano Smoothing

#### Notice

Certain functions may require additional hardware, different CPU type or additional memory capacity or may cause compatibility issue with other functions. In case of doubt, contact your FANUC sales representative for additional information and support.

The information given in the FANUC manuals or original manufacturer documentation shall prevail. Technical data is subject to change without prior notice. No part of this document may be reproduced in any form. All rights reserved. © FANUC 2017

# 165

## Interpolation Functions

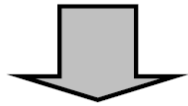
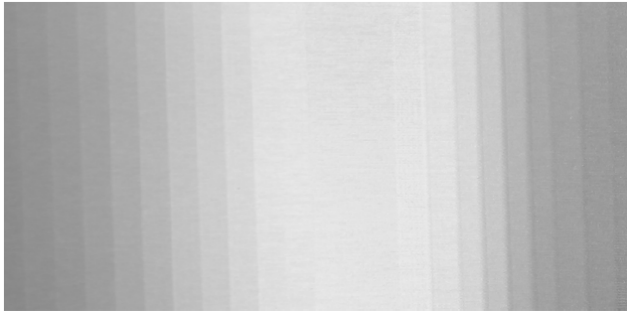

## Smooth Tolerance Control

### Features

Smooth Tolerance Control improves the surface quality and accuracy of parts with free-form surfaces, which are often found in die/mold machining. Free-form surfaces are usually approximated by a sequence of multiple small linear elements. This leads to the undesired consequence that the transitions between linear blocks are visible on the surface of the workpiece after machining.

Smooth Tolerance Control has a sophisticated algorithm which converts a sequence of multiple small blocks automatically into a smooth curve which approximates that sequence within a given tolerance. This eliminates the surface artifacts and leads to a smoothly finished surface.

Smooth Tolerance Control detects corners in the path automatically. If a corner is detected, it is also converted into a smooth curve within a distinct tolerance. High-quality and high-precision machining is achieved with this feature.

Users can machine a workpiece that meets individual specifications by simply defining the two tolerances stated above. This saves time spent on fine-tuning the machined surface. Whether the path to be machined belongs to a free-form surface where a smooth finish is required, or to a corner where the priority is set on precision is determined automatically, meaning that both requirements can be fulfilled simultaneously.

### Benefits

- Enhance surface quality of machined parts
- Simplify fine-tuning of surface quality

### Ordering Information

Specification	Description
A02B-0323-R696	30i-B Tolerance Control
A02B-0326-R696	31i-B5 Tolerance Control
A02B-0327-R696	31i-B Tolerance Control
A02B-0328-R696	32i-B Tolerance Control
A02B-0340-R696	0i-MF Tolerance Control

#### Notice

Certain functions may require additional hardware, different CPU type or additional memory capacity or may cause compatibility issue with other functions. In case of doubt, contact your FANUC sales representative for additional information and support.

The information given in the FANUC manuals or original manufacturer documentation shall prevail. Technical data is subject to change without prior notice. No part of this document may be reproduced in any form. All rights reserved. © FANUC 2017

# 166

## Interpolation Functions

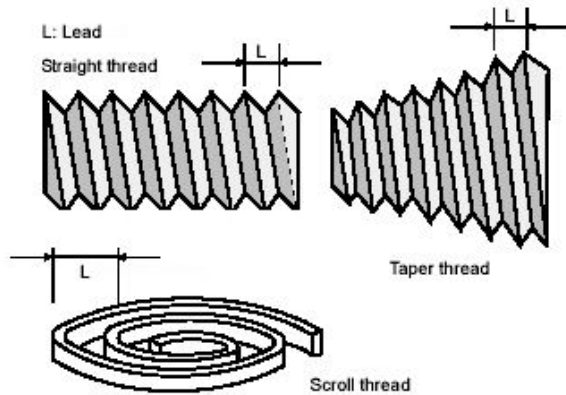

## Thread Cutting, Synchronous Cutting

### Features

When feeding the tool in synchronization with the spindle rotation a threading of the specified lead can be performed with the Thread Cutting / Synchronous Cutting function.

In addition to straight threads, taper threads and scroll threads can be cut with equal leads. The spindle encoder is used to accurately initiate axis motion.

This function is a basic function in FANUC Series 0i-MF and 0i-TF.

### Benefits

- Allows thread cutting on large holes, with single point tooling
- Accurate machining on multiple threading passes

### Ordering Information

Specification	Description
A02B-0323-J824	30i-B Thread Cutting, Synchronous Cutting
A02B-0326-J824	31i-B5 Thread Cutting, Synchronous Cutting
A02B-0327-J824	31i-B Thread Cutting, Synchronous Cutting
A02B-0328-J824	32i-B Thread Cutting, Synchronous Cutting

### Notice

Certain functions may require additional hardware, different CPU type or additional memory capacity or may cause compatibility issue with other functions. In case of doubt, contact your FANUC sales representative for additional information and support.

The information given in the FANUC manuals or original manufacturer documentation shall prevail. Technical data is subject to change without prior notice. No part of this document may be reproduced in any form. All rights reserved. © FANUC 2017

# 167

## Interpolation Functions

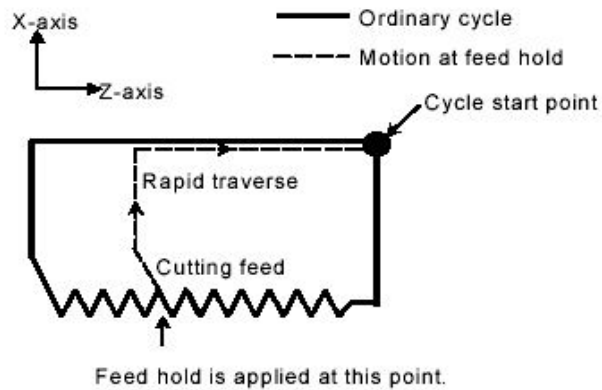

## Thread Cutting Retract

### Features

Threading Retract (Canned Cycle)

Feed hold may be applied during threading. In this case, the tool immediately retracts with chamfering and returns to the start point on the second axis (X-axis), then the first axis (Z-axis) on the plane.

The amount of chamfering during retraction is the same as that of chamfering at the end point.

Threading Retract (Multiple Repetitive Cycle)

If feed hold is applied during threading in the multiple repetitive threading cycle (G76), chamfering for threading is performed and the tool returns to the threading cycle start point and stops. If a cycle start operation is performed here, machining restarts with the threading cycle to which feed hold was applied.

The amount of chamfering during retraction is the same as that of chamfering at the end point.

This function is a basic function in FANUC Series 0i-TF.

### Benefits

- Adds additional modes to the thread cutting operation
- Simplifies programming and restart
- Improves overall machining productivity

### Ordering Information

Specification	Description
A02B-0323-J825	30i-B Thread Cutting Retract
A02B-0326-J825	31i-B5 Thread Cutting Retract
A02B-0327-J825	31i-B Thread Cutting Retract
A02B-0328-J825	32i-B Thread Cutting Retract

#### Notice

Certain functions may require additional hardware, different CPU type or additional memory capacity or may cause compatibility issue with other functions. In case of doubt, contact your FANUC sales representative for additional information and support.

The information given in the FANUC manuals or original manufacturer documentation shall prevail. Technical data is subject to change without prior notice. No part of this document may be reproduced in any form. All rights reserved. © FANUC 2017



# 168

## Interpolation Functions

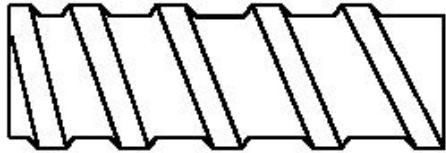

Variable lead screw

## Variable Lead Thread Cutting

### Features

This function allows while specifying an increment or a decrement value for a lead per screw revolution a variable lead threading to be performed.

This function is a basic function in FANUC Series 0i-TF.

### Benefits

- Adds additional advanced threading capabilities to the CNC
- Simplifies programming
- Improves overall machining productivity

### Ordering Information

Specification	Description
A02B-0323-J827	30i-B Variable Lead Thread Cutting
A02B-0326-J827	31i-B5 Variable Lead Thread Cutting
A02B-0327-J827	31i-B Variable Lead Thread Cutting
A02B-0328-J827	32i-B Variable Lead Thread Cutting

#### Notice

Certain functions may require additional hardware, different CPU type or additional memory capacity or may cause compatibility issue with other functions. In case of doubt, contact your FANUC sales representative for additional information and support.

The information given in the FANUC manuals or original manufacturer documentation shall prevail. Technical data is subject to change without prior notice. No part of this document may be reproduced in any form. All rights reserved. © FANUC 2017

# 169

## Interpolation Functions

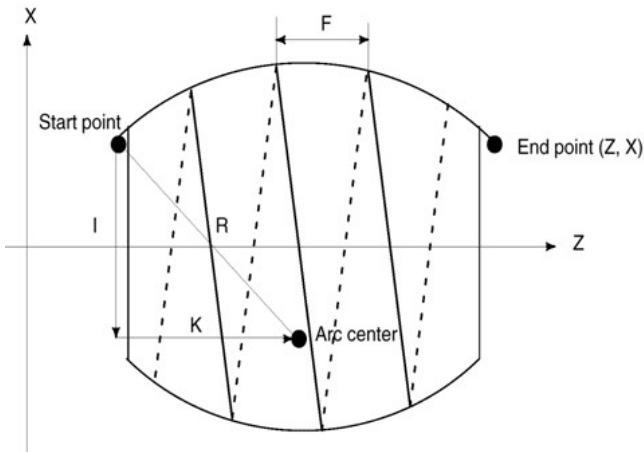
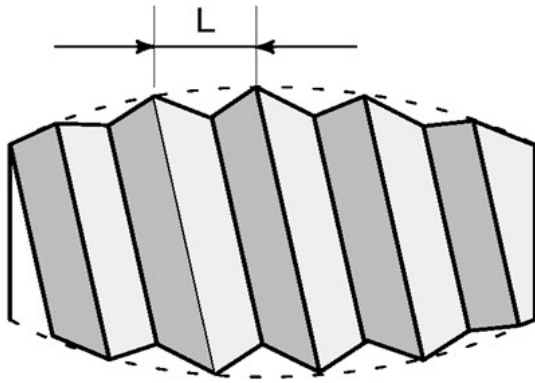

### Notice

Certain functions may require additional hardware, different CPU type or additional memory capacity or may cause compatibility issue with other functions. In case of doubt, contact your FANUC sales representative for additional information and support.

The information given in the FANUC manuals or original manufacturer documentation shall prevail. Technical data is subject to change without prior notice. No part of this document may be reproduced in any form. All rights reserved. © FANUC 2017

# Circular Thread Cutting

## Features

Allows threading of circular surfaces such as cylinder. Easy to program with simple G code (G35 and G36)

## Benefits

- Adds advanced capabilities for thread cutting to the CNC
- Simplifies programming
- Improves overall machining productivity

## Ordering Information

Specification	Description
A02B-0323-J731	30i-B Circular Thread Cutting
A02B-0326-J731	31i-B5 Circular Thread Cutting
A02B-0327-J731	31i-B Circular Thread Cutting
A02B-0328-J731	32i-B Circular Thread Cutting
A02B-0339-J731	0i-TF Circular Thread Cutting

# 170

## Interpolation Functions

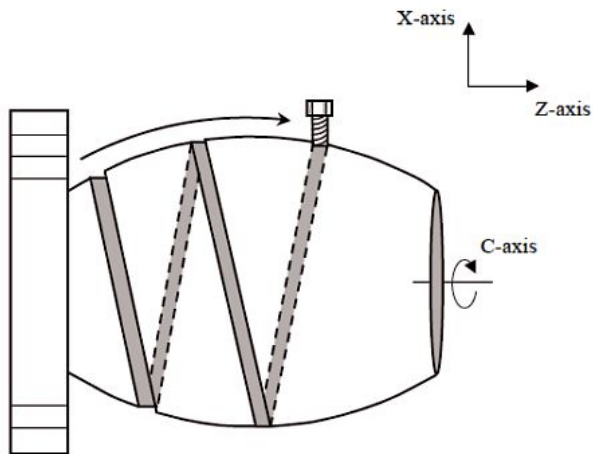

## Circular Thread Cutting B

### Features

The Circular Thread Cutting B function performs circular interpolation according to the feed rate of the major axis, which has longer travelling distance. At the same time, up to two axes can be interpolated in proportion to the feed rate of the major axis.

This circular threading function does not move a tool in synchronization with the rotation of the spindle(workpiece) using the spindle motor.

This function controls workpiece rotation using a servo motor(rotation axis) to perform threading at equal pitches along cylindrical material, grooving, and tool grinding.

### Benefits

- Adds additional advanced thread cutting capabilities to the CNC
- Simplifies programming
- Improves overall machining productivity

### Ordering Information

Specification	Description
A02B-0323-R631	30i-B Circular Thread Cutting B
A02B-0326-R631	31i-B5 Circular Thread Cutting B
A02B-0327-R631	31i-B Circular Thread Cutting B

#### Notice

Certain functions may require additional hardware, different CPU type or additional memory capacity or may cause compatibility issue with other functions. In case of doubt, contact your FANUC sales representative for additional information and support.

The information given in the FANUC manuals or original manufacturer documentation shall prevail. Technical data is subject to change without prior notice. No part of this document may be reproduced in any form. All rights reserved. © FANUC 2017

# 171

## Interpolation Functions

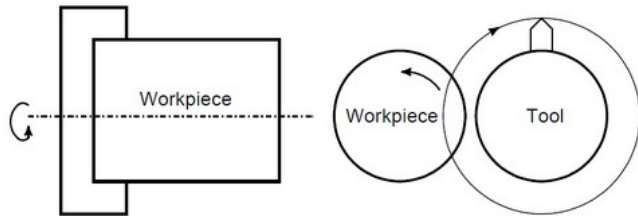

# Polygon Turning

## Features

The Polygon Turning function allows the programmer to machine (turn) a workpiece into a polygonal figure by rotating the workpiece (spindle axis) and tool (rotary tool axis) at a certain ratio.

This function is a basic function in FANUC Series 0i-TF.

## Benefits

- Provides the capability to machine square and / or hexagonal heads on bolts or hexagonal nuts.
- Simplifies programming
- Improves overall machining productivity

## Ordering Information

Specification	Description
A02B-0323-J817	30i-B Polygon Turning
A02B-0326-J817	31i-B5 Polygon Turning
A02B-0327-J817	31i-B Polygon Turning
A02B-0328-J817	32i-B Polygon Turning
A02B-0339-J817	0i-TF Polygon Turning

### Notice

Certain functions may require additional hardware, different CPU type or additional memory capacity or may cause compatibility issue with other functions. In case of doubt, contact your FANUC sales representative for additional information and support.

The information given in the FANUC manuals or original manufacturer documentation shall prevail. Technical data is subject to change without prior notice. No part of this document may be reproduced in any form. All rights reserved. © FANUC 2017

# 172

## Interpolation Functions

# Polygon Machining with Two Spindles

## Features

The Polygon Turning with Two Spindles function allows the programmer to machine (turn) a workpiece into a polygonal figure by rotating the workpiece and the tool at a certain ratio. Both axes must be spindle axes, each controlled by a Serial Spindle.

This function is a basic function in FANUC Series 0i-TF.

## Benefits

- Polygon Turning with Two Spindles is used for machining square and/or hexagonal heads on bolts, or for hexagonal nuts, where the two synchronized axes are spindle axes
- Important feature on lathes with mill-turn capability
- With a multiple path system, polygon turning is possible on each path

## Ordering Information

Specification	Description
A02B-0323-J708	30i-B Polygon Turning with Two Spindles
A02B-0326-J708	31i-B5 Polygon Turning with Two Spindles
A02B-0327-J708	31i-B Polygon Turning with Two Spindles
A02B-0328-J708	32i-B Polygon Turning with Two Spindles
A02B-0339-J708	0i-TF Polygon Turning with Two Spindles

### Notice

Certain functions may require additional hardware, different CPU type or additional memory capacity or may cause compatibility issue with other functions. In case of doubt, contact your FANUC sales representative for additional information and support.

The information given in the FANUC manuals or original manufacturer documentation shall prevail. Technical data is subject to change without prior notice. No part of this document may be reproduced in any form. All rights reserved. © FANUC 2017

# 173

## Interpolation Functions

# Multi-Step Skip Function

## Features

The Multi Step Skip Function, activated in a block by specifying P1 to P4 after G31, stores coordinates in a custom macro variable, when a skip signal, (4-point or 8-point; 8-point when a high-speed skip signal is used) is turned on.

In the block where Q1 to Q4 are specified after G04, dwell can be skipped when skip signals (four or eight signals, or eight signals when high-speed skip signals are used) are input. A skip signal from equipment such as a fixed-dimension measuring instrument can be used to skip programs being executed.

In plunge grinding, for example, a series of operations from rough machining to spark-out can be performed automatically by applying a skip signal each time rough machining, semi-fine machining, fine-machining, or spark-out operation is completed.

## Note

The Multi Step Skip Function requires the Custom Macro B option to be able to access the stored variables.

## Benefits

- Adds special skip functions to the CNC
- Simplifies programming
- Improves overall machining productivity

## Ordering Information

Specification	Description
A02B-0323-J849	30i-B Multi-Step Skip Function
A02B-0326-J849	31i-B5 Multi-Step Skip Function
A02B-0327-J849	31i-B Multi-Step Skip Function
A02B-0328-J849	32i-B Multi-Step Skip Function
A02B-0339-J849	0i-TF Multi-Step Skip
A02B-0340-J849	0i-MF Multi-Step Skip

### Notice

Certain functions may require additional hardware, different CPU type or additional memory capacity or may cause compatibility issue with other functions. In case of doubt, contact your FANUC sales representative for additional information and support.

The information given in the FANUC manuals or original manufacturer documentation shall prevail. Technical data is subject to change without prior notice. No part of this document may be reproduced in any form. All rights reserved. © FANUC 2017

# 174

## Interpolation Functions

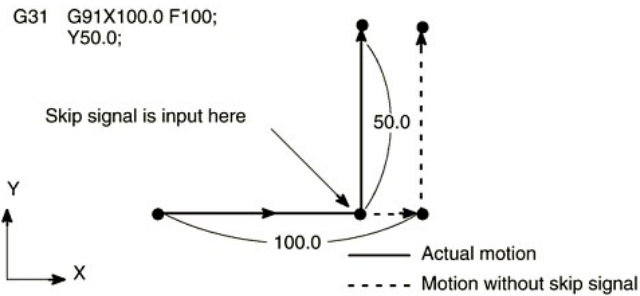

## High-Speed Skip Function

### Features

The High-Speed Skip Function allows the skip function to operate based on a high-speed skip input signal, connected directly to the CNC; not via the PMC like the ordinary skip signal.

Up to eight high-speed signals can be input for the Series 30i-B, up to four high-speed signals can be input for the Series 0i-F.

The response time of the skip signal input is 2 msec at the CNC side (not considering those at the PMC side). The high-speed skip signal input function keeps this value to 0.1 msec or less, thus allowing high precision measurement.

This function is a basic function in FANUC Series 0i-F.

### Benefits

- Faster response improves accuracy at higher feed rates
- Improves cycle time

### Ordering Information

Specification	Description
A02B-0323-J848	30i-B High-Speed Skip
A02B-0326-J848	31i-B5 High-Speed Skip
A02B-0327-J848	31i-B High-Speed Skip
A02B-0328-J848	32i-B High-Speed Skip
A02B-0333-J848	35i-B High-Speed Skip
A02B-0334-J848	PM i-A High-Speed Skip

#### Notice

Certain functions may require additional hardware, different CPU type or additional memory capacity or may cause compatibility issue with other functions. In case of doubt, contact your FANUC sales representative for additional information and support.

The information given in the FANUC manuals or original manufacturer documentation shall prevail. Technical data is subject to change without prior notice. No part of this document may be reproduced in any form. All rights reserved. © FANUC 2017

# 175

## Interpolation Functions

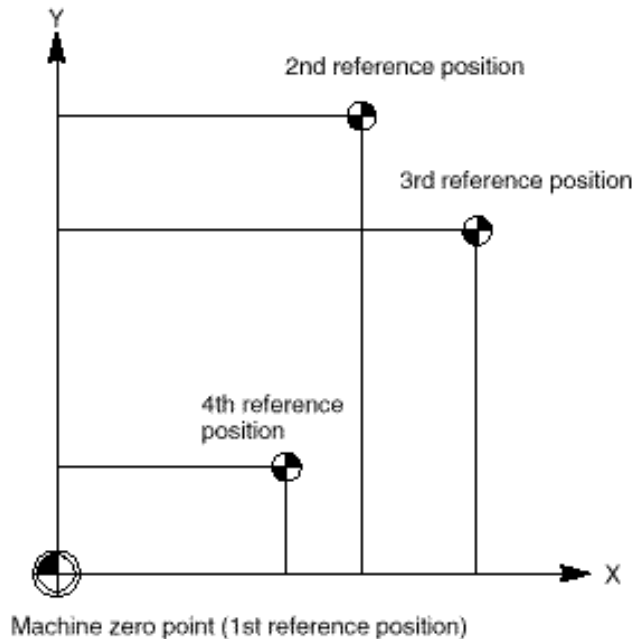

## 3rd/4th Reference Position Return

### Features

The 3rd/4th Reference Position Return function provides two G-codes to position the machine to two fixed points in the machine coordinate system (regardless of the part zero location).

Fixed point locations can be easily changed in parameters.

This function is a basic function in FANUC Series 0i-MF and 0i-TF.

### Benefits

- Reduced cycle or set up time
- Operator MDI's or programs a G-code, instead of manually moving the axis to a fixed position for part change, inspection, etc.

### Ordering Information

Specification	Description
A02B-0323-J830	30i-B 3rd / 4th Reference Point Return
A02B-0326-J830	31i-B5 3rd / 4th Reference Point Return
A02B-0327-J830	31i-B 3rd / 4th Reference Point Return
A02B-0328-J830	32i-B 3rd / 4th Reference Point Return

#### Notice

Certain functions may require additional hardware, different CPU type or additional memory capacity or may cause compatibility issue with other functions. In case of doubt, contact your FANUC sales representative for additional information and support.

The information given in the FANUC manuals or original manufacturer documentation shall prevail. Technical data is subject to change without prior notice. No part of this document may be reproduced in any form. All rights reserved. © FANUC 2017



# 176

## Interpolation Functions

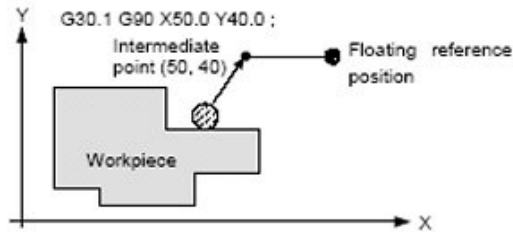

## Floating Reference Position Return

### Features

With the Floating Reference Position Return function, tools can be returned to the floating reference position.

A floating reference position is a position on a machine tool, and serves as a reference position for machine tool operation.

A floating reference position does not always need to be fixed, but can be moved as required.

### Benefits

- Adds flexibility to the machine
- Simplifies programming
- Improves overall machining productivity

### Ordering Information

Specification	Description
A02B-0323-J831	30i-B Floating Reference Position Return
A02B-0326-J831	31i-B5 Floating Reference Position Return
A02B-0327-J831	31i-B Floating Reference Position Return
A02B-0328-J831	32i-B Floating reference Position Return

### Notice

Certain functions may require additional hardware, different CPU type or additional memory capacity or may cause compatibility issue with other functions. In case of doubt, contact your FANUC sales representative for additional information and support.

The information given in the FANUC manuals or original manufacturer documentation shall prevail. Technical data is subject to change without prior notice. No part of this document may be reproduced in any form. All rights reserved. © FANUC 2017

# 177

## Interpolation Functions

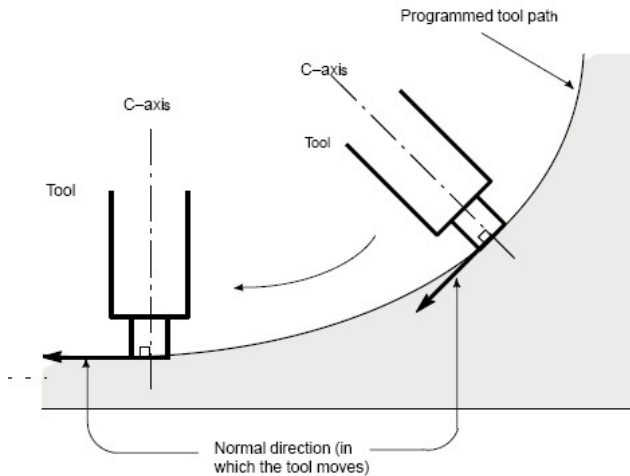

## Normal Direction Control

### Features

In the Normal Direction Control, the rotary axis (C axis) can be commanded so that the tool constantly faces the advancing workpiece and is always perpendicular to the plane of the workpiece during cutting.

This function is a basic function in FANUC Series 0i-MF and 0i-PF.

### Benefits

- Used on precision Jig Grinders to rotate the C Axis to keep it normal (perpendicular) to a position in the X-Y plane.

### Ordering Information

Specification	Description
A02B-0323-J813	30i-B Normal Direction Control
A02B-0326-J813	31i-B5 Normal Direction Control
A02B-0327-J813	31i-B Normal Direction Control
A02B-0328-J813	32i-B Normal Direction Control
A02B-0339-J813	0i-TF Normal Direction Control

### Notice

Certain functions may require additional hardware, different CPU type or additional memory capacity or may cause compatibility issue with other functions. In case of doubt, contact your FANUC sales representative for additional information and support.

The information given in the FANUC manuals or original manufacturer documentation shall prevail. Technical data is subject to change without prior notice. No part of this document may be reproduced in any form. All rights reserved. © FANUC 2017

# 178

## Interpolation Functions

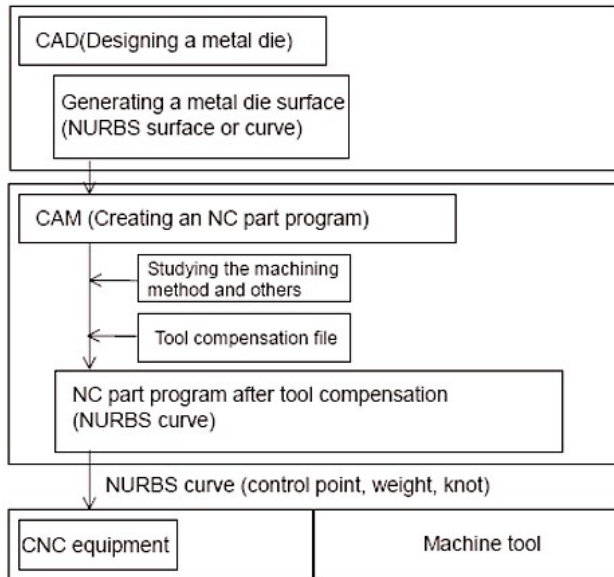

### Notice

Certain functions may require additional hardware, different CPU type or additional memory capacity or may cause compatibility issue with other functions. In case of doubt, contact your FANUC sales representative for additional information and support.

The information given in the FANUC manuals or original manufacturer documentation shall prevail. Technical data is subject to change without prior notice. No part of this document may be reproduced in any form. All rights reserved. © FANUC 2017

## NURBS Interpolation

### Features

Many Computer-Aided Design (CAD) systems used to design metal dies or complex shapes utilize Non-Uniform Rational B Spline (NURBS) to express a sculptured surface or curve for the metal dies.

The NURBS Interpolation function provides the operator with the ability to execute a NURBS program once it has been transferred to the CNC.

The CNC is capable of compensating for tool variations etc., then running the NURBS program.

### Benefits

- CNC compatibility with the widely accepted CAD/CAM NURBS format.
- NURBS part programs are smaller programs than the equivalent conventional piece-wise linear block segments, are processed more quickly by the CNC, and therefore reduce the likelihood of dwell marks in the workpiece.
- Due to the smaller NURBS part program size, the need for high-speed transfer between the CNC and an external PC may be avoided (normally required for conventional part programs of large size).

### Ordering Information

Specification	Description
A02B-0323-J669	30i-B NURBS Interpolation
A02B-0326-J669	31i-B5 NURBS Interpolation
A02B-0327-J669	31i-B NURBS Interpolation

# 179

## Interpolation Functions

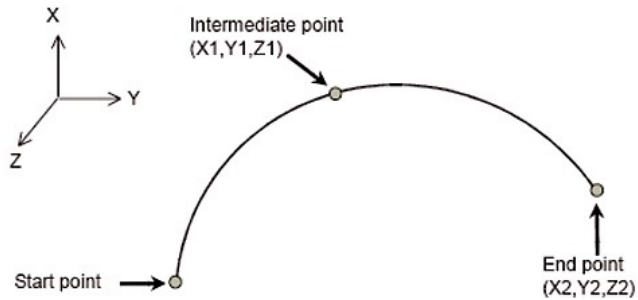

## 3-Dimensional Circular Interpolation

### Features

The 3-Dimensional Circular Interpolation function allows the programmer to specify an arc in 3-D space, using the current position as the start point.

### Benefits

- Permits the programmer to describe an arc, using the current position as the start point, and specifying any intermediate point, plus the end point.

### Ordering Information

Specification	Description
A02B-0323-S673	30i-B 3-Dimensional Circular Interpolation
A02B-0326-S673	31i-B5 3-Dimensional Circular Interpolation
A02B-0327-S673	31i-B 3-Dimensional Circular Interpolation

#### Notice

Certain functions may require additional hardware, different CPU type or additional memory capacity or may cause compatibility issue with other functions. In case of doubt, contact your FANUC sales representative for additional information and support.

The information given in the FANUC manuals or original manufacturer documentation shall prevail. Technical data is subject to change without prior notice. No part of this document may be reproduced in any form. All rights reserved. © FANUC 2017

# 180

## Interpolation Functions

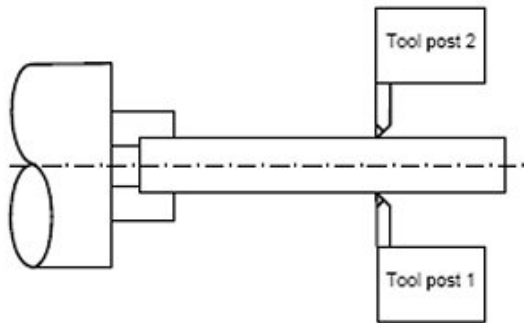

## Balanced Cutting

### Features

The Balanced Cutting function can be used when machining a single part with two turrets at the same time.

If a thin workpiece needs to be machined a precision machining can be achieved by machining each side of the workpiece with a tool simultaneously; this function can prevent the workpiece from warpage that can result when only one side is machined at a time (see the figure below).

When both sides are machined at the same time, the movement of one tool must be in phase with that of the other tool. Otherwise, the workpiece can vibrate, resulting in poor machining. With this function, the movement of one tool post can be easily synchronized with that of the other tool post.

### Benefits

- Adds special function to machine thin parts to the CNC
- Simplifies programming
- Improves overall machining productivity

### Ordering Information

Specification	Description
A02B-0323-J834	30i-B Balanced Cutting
A02B-0326-J834	31i-B5 Balanced Cutting
A02B-0327-J834	31i-B Balanced Cutting
A02B-0328-J834	32i-B Balanced Cutting
A02B-0339-J834	0i-TF Balanced Cutting

#### Notice

Certain functions may require additional hardware, different CPU type or additional memory capacity or may cause compatibility issue with other functions. In case of doubt, contact your FANUC sales representative for additional information and support.

The information given in the FANUC manuals or original manufacturer documentation shall prevail. Technical data is subject to change without prior notice. No part of this document may be reproduced in any form. All rights reserved. © FANUC 2017

# 181

## Interpolation Functions

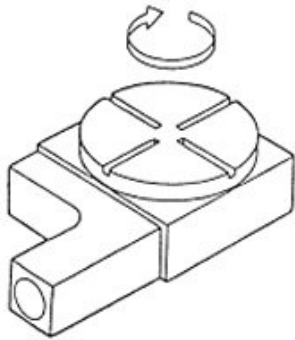

## Index Table Indexing

### Features

The Table Indexing function can be used to control rotary axes that index between predefined locations. By specifying indexing positions (angles) for the indexing axis (one arbitrary axis), the index table of the machining center can be indexed.

It is not necessary to command the exclusive M code in order to clamp or unclamp the table, the CNC will automatically send signals to the PMC to do this, and therefore programming will be easier.

This function is a basic function in FANUC Series 0i-MF.

### Benefits

- Simplifies the integration of a rotary table in the machine
- Simplifies programming
- Improves overall machining productivity

### Ordering Information

Specification	Description
A02B-0323-J822	30i-B Index Table Indexing
A02B-0326-J822	31i-B5 Index Table Indexing
A02B-0327-J822	31i-B Index Table Indexing
A02B-0328-J822	32i-B Index Table Indexing

#### Notice

Certain functions may require additional hardware, different CPU type or additional memory capacity or may cause compatibility issue with other functions. In case of doubt, contact your FANUC sales representative for additional information and support.

The information given in the FANUC manuals or original manufacturer documentation shall prevail. Technical data is subject to change without prior notice. No part of this document may be reproduced in any form. All rights reserved. © FANUC 2017

# 182

## Interpolation Functions

G31 P90  $\alpha$ \_\_ F\_\_

$\alpha$ \_\_: Skip axis address and amount of travel  
Only one axis can be specified. G31 is a one-shot G code.

## Continuous High-Speed Skip

### Features

The Continuous High-Speed Skip function enables the reading of absolute coordinates by using the high-speed skip signal.

Once a high-speed skip signal has been input in a G31 P90 block, the absolute coordinates are read into custom macro variables #5061 to #5068.

The input of a skip signal does not stop axial movement, thus enabling reading of the coordinates of two or more points. The rising and falling edges of the high-speed skip signal can be used as a trigger, depending on the parameter setting.

### Benefits

- Adds advanced skip capabilities to the CNC
- Simplifies programming
- Improves overall machining productivity

### Ordering Information

Specification	Description
A02B-0323-J770	30i-B Continuous High-Speed Skip
A02B-0326-J770	31i-B5 Continuous High-Speed Skip
A02B-0327-J770	31i-B Continuous High-Speed Skip
A02B-0328-J770	32i-B Continuous High-Speed Skip
A02B-0339-J770	0i-TF Continuous High-Speed Skip
A02B-0340-J770	0i-MF Continuous High-Speed Skip

#### Notice

Certain functions may require additional hardware, different CPU type or additional memory capacity or may cause compatibility issue with other functions. In case of doubt, contact your FANUC sales representative for additional information and support.

The information given in the FANUC manuals or original manufacturer documentation shall prevail. Technical data is subject to change without prior notice. No part of this document may be reproduced in any form. All rights reserved. © FANUC 2017

# 183

## Interpolation Functions

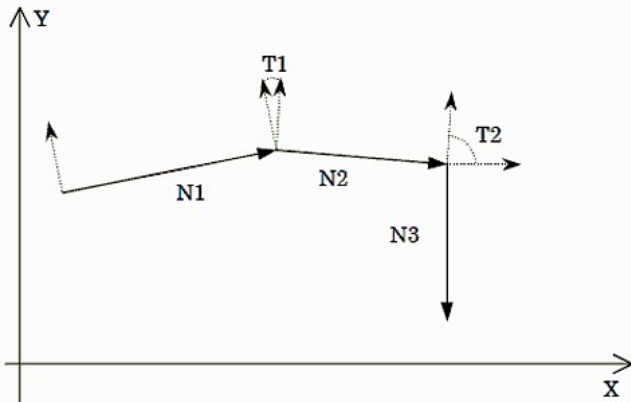

$\alpha$  : The value of parameter No.5485

T1 : The angle which rotates from N1 to N2 ( $T1 < \alpha$ )

T2 : The angle which rotates from N2 to N3 ( $T2 \geq \alpha$ )

## Gentle Normal Direction Control

### Features

On a machine where a rotary axis controls the tool direction (typically the C-axis) Normal Direction Control function will automatically position the 'C' tool-axis in order to maintain the same angular relationship of the tool with respect to any programmed path direction change in the X-Y coordinate system.

In regular normal-direction control mode [J813], the rotation of the normal-direction controlled tool-axis [C-axis] is inserted between any axes [X/Y axis] direction changes. The X/Y axes always stop while the C-axis rotates to the new normal position for the next program block.

Sometimes, for small angle X/Y direction changes, it is not desirable to stop the X/Y axes while the in C-axis [Tool-axis] rotates to position. In Gentle Normal Direction Control mode, providing the C-axis rotation angle is less than a parametrically set angle, the X/Y axes do not stop while the C-axis rotates to the new normal position.

### Benefits

- Used on precision Jig Grinders to rotate the C-Axis to keep it normal (perpendicular) to a position in the X-Y plane.
- Useful for servo-controlled grinding diamond wheel dresser. Maintains the angle of diamond tip angle with respect to grinding wheel dress form.
- Gentle function prevents dwells where over-cutting could occur.

### Ordering Information

Specification	Description
A02B-0323-J986	30i-B Gentle Normal Direction Control
A02B-0326-J986	31i-B5 Gentle Normal Direction Control
A02B-0327-J986	31i-B Gentle Normal Direction Control

#### Notice

Certain functions may require additional hardware, different CPU type or additional memory capacity or may cause compatibility issue with other functions. In case of doubt, contact your FANUC sales representative for additional information and support.

The information given in the FANUC manuals or original manufacturer documentation shall prevail. Technical data is subject to change without prior notice. No part of this document may be reproduced in any form. All rights reserved. © FANUC 2017



# 184

## Interpolation Functions

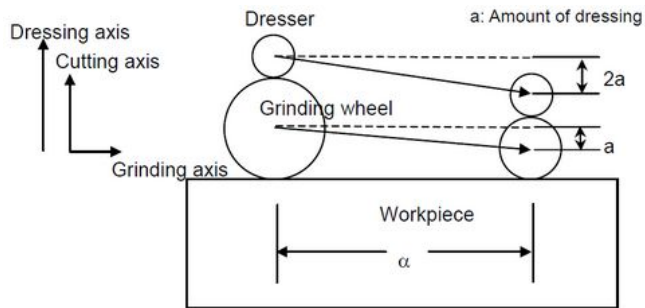

## Continuous Dressing

### Features

The Continuous Dressing function allows continuous dressing during grinding canned cycles (G75, G77, G78, G79).

Grinding and dresser cutting are compensated continuously according to the amount of continuous dressing set by parameters.

### Benefits

- Automated production for large volume grinding
- Simplifies programming
- Improves overall machining productivity

### Ordering Information

Specification	Description
A02B-0323-J630	30i-B Continuous Dressing
A02B-0326-J630	31i-B5 Continuous Dressing
A02B-0327-J630	31i-B Continuous Dressing
A02B-0328-J630	32i-B Continuous Dressing

### Notice

Certain functions may require additional hardware, different CPU type or additional memory capacity or may cause compatibility issue with other functions. In case of doubt, contact your FANUC sales representative for additional information and support.

The information given in the FANUC manuals or original manufacturer documentation shall prevail. Technical data is subject to change without prior notice. No part of this document may be reproduced in any form. All rights reserved. © FANUC 2017

# 185

## Interpolation Functions

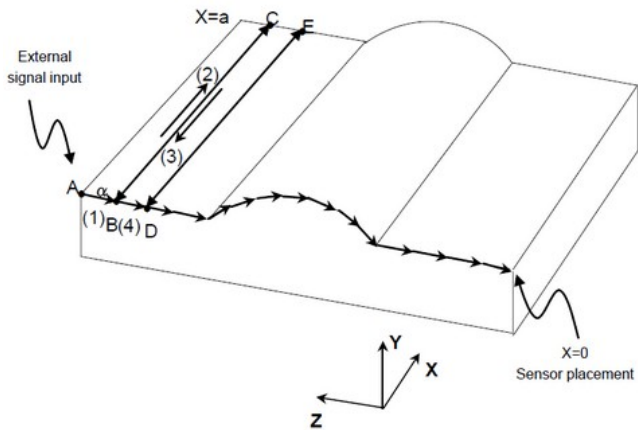

## Infeed Control

### Features

The Infeed Control function can be used on grinding machines. Every time an external signal is input, the machine is moved by a fixed amount along the programmed profile in the specified Y-Z plane.

### Benefits

- Automatically repeat cutting motion from an external signal such as push button from operator panel
- Simplifies programming
- Improves overall machining productivity

### Ordering Information

Specification	Description
A02B-0323-J631	30i-B Infeed Control
A02B-0326-J631	31i-B5 Infeed Control
A02B-0327-J631	31i-B Infeed Control
A02B-0328-J631	32i-B Infeed Control

### Notice

Certain functions may require additional hardware, different CPU type or additional memory capacity or may cause compatibility issue with other functions. In case of doubt, contact your FANUC sales representative for additional information and support.

The information given in the FANUC manuals or original manufacturer documentation shall prevail. Technical data is subject to change without prior notice. No part of this document may be reproduced in any form. All rights reserved. © FANUC 2017

# 186

## Interpolation Functions

# High-Speed Cycle Cutting

## Features

The High-Speed Cycle Machining function (also called High-Speed Cycle Cutting) is a function that accepts as input machining profil data consisting of command data for each involved axis based selected time interval, then distributes that data immediately to the motors controlling up to six designated axes.

Preparing the cycle data requires the use of the macro compiler and macro executor. The resulting cycle data must be operated on by the G05 command in the part program.

## Benefits

- By virtue of being command data without interpolation, the CNC needs minimal overhead to deliver the required cycle data to the affected axes.
- Faster execution of the part program results, leading to higher productivity for the machine tool.
- Simplifies programming
- Improves overall machining productivity

## Ordering Information

Specification	Description
A02B-0323-J832	30i-B High-Speed Cycle Machining
A02B-0326-J832	31i-B5 High-Speed Cycle Machining
A02B-0327-J832	31i-B High-Speed Cycle Machining

### Notice

Certain functions may require additional hardware, different CPU type or additional memory capacity or may cause compatibility issue with other functions. In case of doubt, contact your FANUC sales representative for additional information and support.

The information given in the FANUC manuals or original manufacturer documentation shall prevail. Technical data is subject to change without prior notice. No part of this document may be reproduced in any form. All rights reserved. © FANUC 2017

# 187

## Interpolation Functions

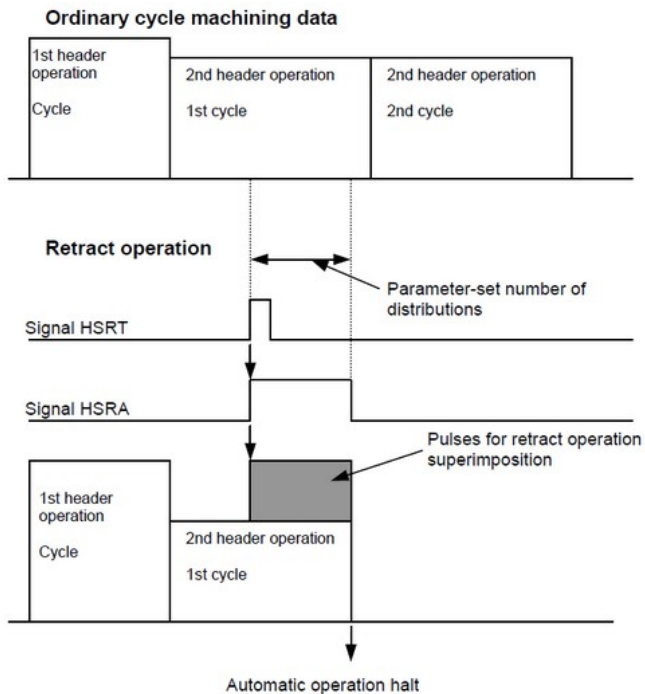

# High-Speed Cycle Machining Retract Function

## Features

When machining based on the high-speed cycle machining function needs to be stopped for a reason, the High-Speed Cycle Machining Retract function enables a retract operation to be performed by setting the retract selection signal HSRT (Gn065.3) to 1.

By registering a retract cycle in the high-speed cycle header, a cycle for performing an operation such as a special retract operation after a retract operation can be specified and executed.

## Benefits

- Simplifies repetitive cycle programming in the CNC
- Improves overall machining productivity

## Ordering Information

Specification	Description
A02B-0323-J663	30i-B High-Speed Cycle Machining - Retract Function
A02B-0326-J663	31i-B5 High-Speed Cycle Machining - Retract Function
A02B-0327-J663	31i-B High-Speed Cycle Machining - Retract Function

### Notice

Certain functions may require additional hardware, different CPU type or additional memory capacity or may cause compatibility issue with other functions. In case of doubt, contact your FANUC sales representative for additional information and support.

The information given in the FANUC manuals or original manufacturer documentation shall prevail. Technical data is subject to change without prior notice. No part of this document may be reproduced in any form. All rights reserved. © FANUC 2017

# 188

## Interpolation Functions

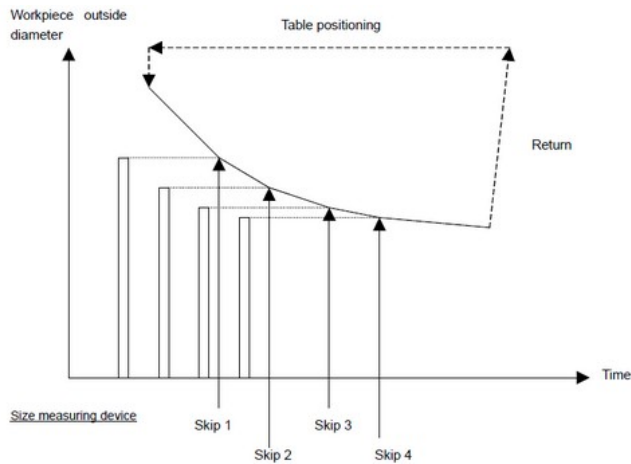

# High-Speed Cycle Machining Skip Function

## Features

The High-Speed Cycle Machining Skip function cancels a repetition cycle operation in high-speed cycle machining and causes a skip to the header information connected next.

Skip signals (HCSK1 to HCSK4) sent from a size measuring device (sensor) can be used to skip a currently executed machining cycle.

For continuous high-speed high-precision machining with a cylindrical grinding machine, for example, skip signals from the size measuring device are used when slight tool wear is detected.

## Benefits

- Adds advanced skip functions to the CNC
- Simplifies programming
- Improves overall machining productivity

## Ordering Information

Specification	Description
A02B-0323-S662	30i-B High-Speed Cycle Machining - Skip Function
A02B-0326-S662	31i-B5 High-Speed Cycle Machining - Skip Function
A02B-0327-S662	31i-B High-Speed Cycle Machining - Skip Function

### Notice

Certain functions may require additional hardware, different CPU type or additional memory capacity or may cause compatibility issue with other functions. In case of doubt, contact your FANUC sales representative for additional information and support.

The information given in the FANUC manuals or original manufacturer documentation shall prevail. Technical data is subject to change without prior notice. No part of this document may be reproduced in any form. All rights reserved. © FANUC 2017

# 189

## Interpolation Functions

# High-Speed Cycle Cutting Additional Variables A

## Features

Variables #200000 to #331071 (131,072 points) are assigned to the High-Speed Cycle Machining function, and may not be used for any other purpose.

## Benefits

- Larger amounts of cycle data are made available to the High-Speed Cutting Command (G05).
- Enhances machine programming capabilities
- Improves overall machining productivity

## Ordering Information

Specification	Description
A02B-0323-J745	30i-B High-Speed Cycle Machining - Additional Variables A
A02B-0326-J745	31i-B5 High-Speed Cycle Machining - Additional Variables A
A02B-0327-J745	31i-B High-Speed Cycle Machining - Additional Variables A

### Notice

Certain functions may require additional hardware, different CPU type or additional memory capacity or may cause compatibility issue with other functions. In case of doubt, contact your FANUC sales representative for additional information and support.

The information given in the FANUC manuals or original manufacturer documentation shall prevail. Technical data is subject to change without prior notice. No part of this document may be reproduced in any form. All rights reserved. © FANUC 2017

# 190

## Interpolation Functions

# High-Speed Cycle Cutting Additional Variables B

## Features

Variables #200000 to #462143 (262,144 points) are assigned to the High-Speed Cycle Machining function, and may not be used for any other purpose.

## Benefits

- Larger amounts of cycle data are made available to the High-Speed Cutting Command (G05).
- Enhances machine programming capabilities
- Improves overall machining productivity

## Ordering Information

Specification	Description
A02B-0323-J746	30i-B High-Speed Cycle Machining - Additional Variables B
A02B-0326-J746	31i-B5 High-Speed Cycle Machining - Additional Variables B
A02B-0327-J746	31i-B High-Speed Cycle Machining - Additional Variables B

### Notice

Certain functions may require additional hardware, different CPU type or additional memory capacity or may cause compatibility issue with other functions. In case of doubt, contact your FANUC sales representative for additional information and support.

The information given in the FANUC manuals or original manufacturer documentation shall prevail. Technical data is subject to change without prior notice. No part of this document may be reproduced in any form. All rights reserved. © FANUC 2017

# 191

## Interpolation Functions

# High-Speed Cycle Cutting Additional Variables C

## Features

Variables #200000 to #986431 (786,432 points) are assigned to the High-Speed Cycle Machining function, and may not be used for any other purpose.

## Benefits

- Larger amounts of cycle data are made available to the High-Speed Cutting Command (G05).
- Enhances machine programming capabilities
- Improves overall machining productivity

## Ordering Information

Specification	Description
A02B-0323-S640	30i-B High-Speed Cycle Machining - Additional Variables C
A02B-0326-S640	31i-B5 High-Speed Cycle Machining - Additional Variables C
A02B-0327-S640	31i-B High-Speed Cycle Machining - Additional Variables C

### Notice

Certain functions may require additional hardware, different CPU type or additional memory capacity or may cause compatibility issue with other functions. In case of doubt, contact your FANUC sales representative for additional information and support.

The information given in the FANUC manuals or original manufacturer documentation shall prevail. Technical data is subject to change without prior notice. No part of this document may be reproduced in any form. All rights reserved. © FANUC 2017



# 192

## Interpolation Functions

# High-Speed Cycle Cutting Additional Variables D

## Features

Variables #2000000 to #3999999 (2,000,000 points) are assigned to the High-Speed Cycle Machining function, and may not be used for any other purpose.

## Benefits

- Larger amounts of cycle data are made available to the High-Speed Cutting Command (G05).
- Enhances machine programming capabilities
- Improves overall machining productivity

## Ordering Information

Specification	Description
A02B-0323-R513	30i-B High-Speed Cycle Machining - Additional Variables D
A02B-0326-R513	31i-B5 High-Speed Cycle Machining - Additional Variables D
A02B-0327-R513	31i-B High-Speed Cycle Machining - Additional Variables D

### Notice

Certain functions may require additional hardware, different CPU type or additional memory capacity or may cause compatibility issue with other functions. In case of doubt, contact your FANUC sales representative for additional information and support.

The information given in the FANUC manuals or original manufacturer documentation shall prevail. Technical data is subject to change without prior notice. No part of this document may be reproduced in any form. All rights reserved. © FANUC 2017

# 193

## Interpolation Functions

# High-Speed Cycle Cutting Additional Variables E

## Features

Variables #2000000 to #4999999 (3,000,000 points) are assigned to the High-Speed Cycle Machining function, and may not be used for any other purpose.

## Benefits

- Larger amounts of cycle data are made available to the High-Speed Cutting Command (G05).
- Enhances machine programming capabilities
- Improves overall machining productivity

## Ordering Information

Specification	Description
A02B-0323-R469	30i-B High-Speed Cycle Machining - Additional Variables E
A02B-0326-R469	31i-B5 High-Speed Cycle Machining - Additional Variables E
A02B-0327-R469	31i-B High-Speed Cycle Machining - Additional Variables E

### Notice

Certain functions may require additional hardware, different CPU type or additional memory capacity or may cause compatibility issue with other functions. In case of doubt, contact your FANUC sales representative for additional information and support.

The information given in the FANUC manuals or original manufacturer documentation shall prevail. Technical data is subject to change without prior notice. No part of this document may be reproduced in any form. All rights reserved. © FANUC 2017

# 194

## Interpolation Functions

# High-Speed Cycle Machining Operation Information Output Function

## Features

This function allows to output operation information to a PMC internal relay during high-speed cycle machining. The information can be used to coordinate subsequent processes and reduce the overall cycle time. The following operation information can be output to the PMC internal relay:

- Starting cycle no.
- Remaining count of repetitions per machining cycle
- Current cycle no.
- Remaining count of repetitions per cycle
- Current P-code variable no.
- Number of data items per cycle (setting data)
- Remaining number of data items per cycle

## Benefits

- Reduce overall cycle time

## Ordering Information

Specification	Description
A02B-0323-R609	30i-B High-Speed Cycle Machining - Operation Information Output Function
A02B-0326-R609	31i-B5 High-Speed Cycle Machining - Operation Information Output Function
A02B-0327-R609	31i-B High-Speed Cycle Machining - Operation Information Output Function

### Notice

Certain functions may require additional hardware, different CPU type or additional memory capacity or may cause compatibility issue with other functions. In case of doubt, contact your FANUC sales representative for additional information and support.

The information given in the FANUC manuals or original manufacturer documentation shall prevail. Technical data is subject to change without prior notice. No part of this document may be reproduced in any form. All rights reserved. © FANUC 2017

# 195

## Interpolation Functions

# General Purpose Retract

## Features

In automatic operation mode or in manual operation mode, setting the retract signal RTRCT to 1 causes the General Purpose Retract function to capture the rise of this signal, causing the tool to move (retract) along the axis for which a retract amount is specified by parameter. After the end of retraction, the retract completion signal RTRCTF is output.

This function is intended to retract the tool from the workpiece immediately when a tool breakage is detected.

This function is a basic function in FANUC Series 0i-MF and 0i-TF.

## Benefits

- Adds special retract function to the CNC
- Simplifies programming
- Improves overall machining productivity

## Ordering Information

Specification	Description
A02B-0323-J997	30i-B General Purpose Retract
A02B-0326-J997	31i-B5 General Purpose Retract
A02B-0327-J997	31i-B General Purpose Retract
A02B-0328-J997	32i-B General Purpose Retract
A02B-0333-J997	35i-B General Purpose Retract

### Notice

Certain functions may require additional hardware, different CPU type or additional memory capacity or may cause compatibility issue with other functions. In case of doubt, contact your FANUC sales representative for additional information and support.

The information given in the FANUC manuals or original manufacturer documentation shall prevail. Technical data is subject to change without prior notice. No part of this document may be reproduced in any form. All rights reserved. © FANUC 2017

# 196

## Interpolation Functions

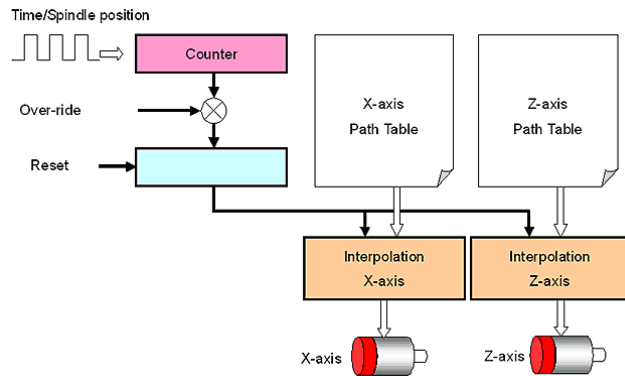

## Path Table Operation (PTO)

### Features

The Path Table Operation function is an advanced machining method which interpolates each axis synchronized with the spindle, axis position or the time based on Tables.

It realizes free motions unbound from the NC program block, and can be used in applications such as swiss lathes or crankshaft pin-milling machines.

### Benefits

- Adds advanced Path Table Operation function to the CNC
- Allows complex interpolations for advanced machining operations
- Provides a high surface quality on complex parts
- Improves overall machining productivity

### Ordering Information

Specification	Description
A02B-0323-S886	30i-B Path Table Operation (PTO)
A02B-0326-S886	31i-B5 Path Table Operation (PTO)
A02B-0327-S886	31i-B Path Table Operation (PTO)

### Notice

Certain functions may require additional hardware, different CPU type or additional memory capacity or may cause compatibility issue with other functions. In case of doubt, contact your FANUC sales representative for additional information and support.

The information given in the FANUC manuals or original manufacturer documentation shall prevail. Technical data is subject to change without prior notice. No part of this document may be reproduced in any form. All rights reserved. © FANUC 2017

# 197

## Interpolation Functions

# Spindle Speed Fluctuation Detection for Path Table Operation

---

## Features

The conventional spindle speed fluctuation detection can be enabled or disabled by G code when executing an NC program, but it cannot be switched in Path Table Operation.

The Spindle Speed Fluctuation Detection for Path Table Operation enables or disables spindle speed fluctuation detection by commanding G code. As a result, the cutting failure caused by spindle speed fluctuation in Path Table Operation can be prevented.

## Benefits

- Adds the capability to monitor spindle speed fluctuation to Path Table Operation
- Reduces the risk to produce bad parts without knowing it
- Simplifies startup and test of programs
- Improves overall machining productivity

## Ordering Information

Specification	Description
A02B-0323-R605	30i-B Path Table Operation (PTO) - Spindle Speed Fluctuation Detection
A02B-0326-R605	31i-B5 Path Table Operation (PTO) - Spindle Speed Fluctuation Detection
A02B-0327-R605	31i-B Path Table Operation (PTO) - Spindle Speed Fluctuation Detection

### Notice

Certain functions may require additional hardware, different CPU type or additional memory capacity or may cause compatibility issue with other functions. In case of doubt, contact your FANUC sales representative for additional information and support.

The information given in the FANUC manuals or original manufacturer documentation shall prevail. Technical data is subject to change without prior notice. No part of this document may be reproduced in any form. All rights reserved. © FANUC 2017

# 198

## Interpolation Functions

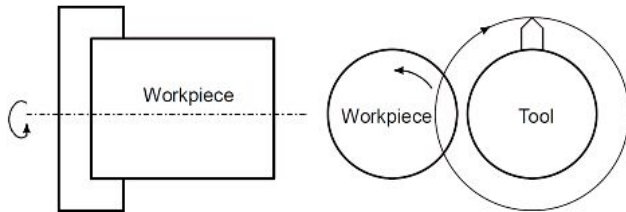

# Polygon Turning Function for Path Table Operation

## Features

The Polygon Turning Function for Path Table Operation enables the polygon turning by the spindle and the tool rotating axis (servo axis).

Polygon turning means machining a workpiece to a polygonal figure by rotating the workpiece and tool at a certain ratio. By changing conditions that are rotation ratio of workpiece and tool and number of cutters, the workpiece can be machined to a square or hexagon. The machining time can be reduced as compared with polygonal figure machining using the polar coordinate interpolation. The machined figure, however, is not exactly polygonal.

Generally, polygon turning is used for the heads of square or hexagon bolts or nuts.

This function uses the spindle as the workpiece axis and the servo axis as the tool rotation axis.

## Benefits

- Provides the polygon turning function to a lathe using Path Table Operation
- Simplifies the programming of lathe producing bolts and nuts
- Increases the productivity of the machine

## Ordering Information

Specification	Description
A02B-0323-R598	30i-B Path Table Operation (PTO) - Polygon Turning Function
A02B-0326-R598	31i-B5 Path Table Operation (PTO) - Polygon Turning Function
A02B-0327-R598	31i-B Path Table Operation (PTO) - Polygon Turning Function

### Notice

Certain functions may require additional hardware, different CPU type or additional memory capacity or may cause compatibility issue with other functions. In case of doubt, contact your FANUC sales representative for additional information and support.

The information given in the FANUC manuals or original manufacturer documentation shall prevail. Technical data is subject to change without prior notice. No part of this document may be reproduced in any form. All rights reserved. © FANUC 2017

# 199

## Interpolation Functions

# Threading Start Position Shift Function for Path Table Operation

---

## Features

In Path Table Operation, this function can command the spindle position at the start of threading with a custom macro common variable.

In this case, the spindle position can be changed simply by changing a variable value, and it is unnecessary to reconvert the Path Table programs.

## Benefits

- Adds the capability to use macro variable position the spindle on threading operation
- Simplifies programming and avoids the conversion of the table when a value is changed
- Increases productivity of the machine

## Ordering Information

Specification	Description
A02B-0323-R599	30i-B Path Table Operation (PTO) - Threading Start Position Shift Function
A02B-0326-R599	31i-B5 Path Table Operation (PTO) - Threading Start Position Shift Function
A02B-0327-R599	31i-B Path Table Operation (PTO) - Threading Start Position Shift Function

### Notice

Certain functions may require additional hardware, different CPU type or additional memory capacity or may cause compatibility issue with other functions. In case of doubt, contact your FANUC sales representative for additional information and support.

The information given in the FANUC manuals or original manufacturer documentation shall prevail. Technical data is subject to change without prior notice. No part of this document may be reproduced in any form. All rights reserved. © FANUC 2017



# 200

## Interpolation Functions

# Tool Offset Function for Path Table Operation

## Features

This function provides the capability to specify Tool Offset with the path table operation of X-axis, Z-axis and Y-axis.

The value of tool geometry offset and tool wear offset in total is compensated when both tool geometry offset number and tool wear offset number are specified. When one side of the tool geometry offset number or the tool wear offset number is specified, only the specified tool offset is done.

## Benefits

- Provides tool offset function to Path Table Operation
- Simplifies the programming
- Increases the productivity of the machine

## Ordering Information

Specification	Description
A02B-0323-R524	30i-B Path Table Operation (PTO) - Tool Offset Function
A02B-0326-R524	31i-B5 Path Table Operation (PTO) - Tool Offset Function
A02B-0327-R524	31i-B Path Table Operation (PTO) - Tool Offset Function

### Notice

Certain functions may require additional hardware, different CPU type or additional memory capacity or may cause compatibility issue with other functions. In case of doubt, contact your FANUC sales representative for additional information and support.

The information given in the FANUC manuals or original manufacturer documentation shall prevail. Technical data is subject to change without prior notice. No part of this document may be reproduced in any form. All rights reserved. © FANUC 2017

# 201

## Interpolation Functions

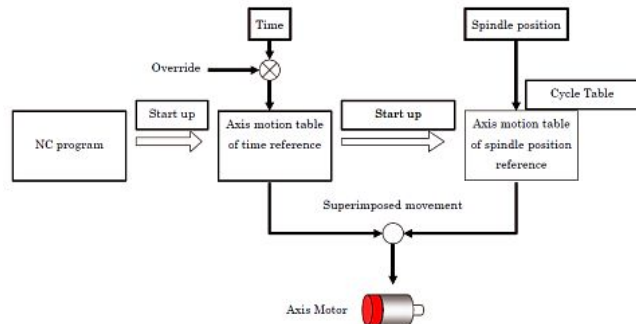

# Cycle Table Operation Function for Path Table Operation

## Features

The axis motion table of spindle position reference can be started up as a "Cycle Table" from the axis motion table of time reference.

The movement commanded by the cycle table and the movement commanded by the axis motion table of time reference are superimposed.

One cycle table can be specified in one axis motion table of time reference.

## Benefits

- Provides interaction between axis and spindle movements
- Simplifies the programming
- Increases the productivity of the machine

## Ordering Information

Specification	Description
A02B-0323-R526	30i-B Path Table Operation (PTO) - Cycle Table Operation
A02B-0326-R526	31i-B5 Path Table Operation (PTO) - Cycle Table Operation
A02B-0327-R526	31i-B Path Table Operation (PTO) - Cycle Table Operation

### Notice

Certain functions may require additional hardware, different CPU type or additional memory capacity or may cause compatibility issue with other functions. In case of doubt, contact your FANUC sales representative for additional information and support.

The information given in the FANUC manuals or original manufacturer documentation shall prevail. Technical data is subject to change without prior notice. No part of this document may be reproduced in any form. All rights reserved. © FANUC 2017

# 202

## Interpolation Functions

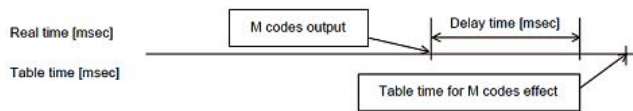

# Delay Time Setting Function of Auxiliary Function Output for PTO

## Features

The Path Table Operation can output M codes, based on the Auxiliary Function Table synchronized with the time, the axis position or the spindle position.

When the Auxiliary Function Table is synchronized with the time, the output of the M codes are realized in real-time since the M codes outputted can be commanded with a "Delay Time".

The Path Table Operation outputs M codes earlier compared to the table time which takes in consideration the "Delay Time". Three M-codes can be output at once. The ordered M code is outputted according to each delay time.

## Benefits

- Provides additional time synchronization for the auxiliary function
- Simplifies the programming
- Increases the productivity of the machine

## Ordering Information

Specification	Description
A02B-0323-R528	30i-B Path Table Operation (PTO) - Delay Time Setting Function of Auxiliary Function Output
A02B-0326-R528	31i-B5 Path Table Operation (PTO) - Delay Time Setting Function of Auxiliary Function Output
A02B-0327-R528	31i-B Path Table Operation (PTO) - Delay Time Setting Function of Auxiliary Function Output

### Notice

Certain functions may require additional hardware, different CPU type or additional memory capacity or may cause compatibility issue with other functions. In case of doubt, contact your FANUC sales representative for additional information and support.

The information given in the FANUC manuals or original manufacturer documentation shall prevail. Technical data is subject to change without prior notice. No part of this document may be reproduced in any form. All rights reserved. © FANUC 2017

# 203

## Interpolation Functions

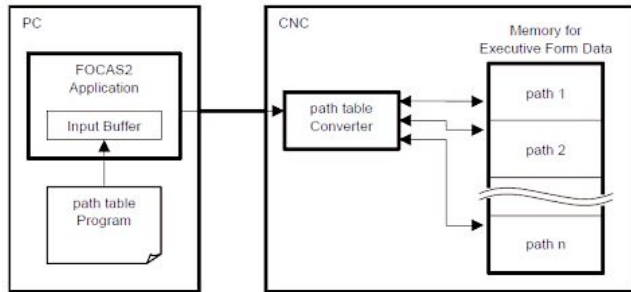

## Path Table Direct Conversion Function

### Features

When a path table program is being executed on the machine, the Path Table Direct Conversion function can directly convert a path table program into another machining process.

It is not necessary to convert all path table programs for all planned machining processes before the start of the operation; incremental path table programs can be converted at the same time the machining takes place. This reduces set-up time for the machine operation.

In addition, since it is also possible to delete path table programs of a process that finished execution, the data memory of the CNC can be used efficiently.

### Benefits

- Efficient management of path programs
- Reduction of memory requirement in the CNC
- Increase of machine efficiency and productivity

### Ordering Information

Specification	Description
A02B-0323-R545	30i-B Path Table Operation (PTO) - Direct Conversion Function
A02B-0326-R545	31i-B5 Path Table Operation (PTO) - Direct Conversion Function
A02B-0327-R545	31i-B Path Table Operation (PTO) - Direct Conversion Function

#### Notice

Certain functions may require additional hardware, different CPU type or additional memory capacity or may cause compatibility issues with other functions. In case of doubt, contact your FANUC sales representative for additional information and support.

The information given in the FANUC manuals or original manufacturer documentation shall prevail. Technical data is subject to change without prior notice. No part of this document may be reproduced in any form. All rights reserved. © FANUC 2017

# 204

## Interpolation Functions

# High-Speed Signal Output Function for Path Table Operation

## Features

This function enables to control outputs at a 0.5msec intervals as high-speed signal to the external equipments connected with I/O Link i in Path Table Operation mode.

It is possible to control external equipments at high-speed in parallel to the Path Table Operation with this function.

Items	Specification
Output cycle	0.5 msec
Number of usable I/O Link i channels	1
Maximum number of output signals	64 points in total for all paths
Maximum number of simultaneously output signals	20 points for all paths

## Benefits

- High-speed control of external devices during Path Table Operation
- Possibility to design complex system combining high-speed outputs with complex PTO cycles

## Ordering Information

Specification	Description
A02B-0323-R564	30i-B Path Table Operation (PTO) - High-Speed Signal Output Function
A02B-0326-R564	31i-B5 Path Table Operation (PTO) - High-Speed Signal Output Function
A02B-0327-R564	31i-B Path Table Operation (PTO) - High-Speed Signal Output Function

### Notice

Certain functions may require additional hardware, different CPU type or additional memory capacity or may cause compatibility issue with other functions. In case of doubt, contact your FANUC sales representative for additional information and support.

The information given in the FANUC manuals or original manufacturer documentation shall prevail. Technical data is subject to change without prior notice. No part of this document may be reproduced in any form. All rights reserved. © FANUC 2017

# 205

## Interpolation Functions

# Incremental Command for Path Table Operation

## Features

In Path Table Operation, reference value or axis position are only specified in absolute commands.

The Incremental Command for Path Table Operation function provides the possibility to specify the reference values and each axis position corresponding to the reference values (time, axis position or spindle position) in incremental commands.

## Benefits

- Possibility to change the mode of definition of the table
- Increases programming flexibility
- Improves overall machining productivity

## Ordering Information

Specification	Description
A02B-0323-R580	30i-B Path Table Operation (PTO) - Incremental Command
A02B-0326-R580	31i-B5 Path Table Operation (PTO) - Incremental Command
A02B-0327-R580	31i-B Path Table Operation (PTO) - Incremental Command

### Notice

Certain functions may require additional hardware, different CPU type or additional memory capacity or may cause compatibility issue with other functions. In case of doubt, contact your FANUC sales representative for additional information and support.

The information given in the FANUC manuals or original manufacturer documentation shall prevail. Technical data is subject to change without prior notice. No part of this document may be reproduced in any form. All rights reserved. © FANUC 2017

# 206

## Interpolation Functions

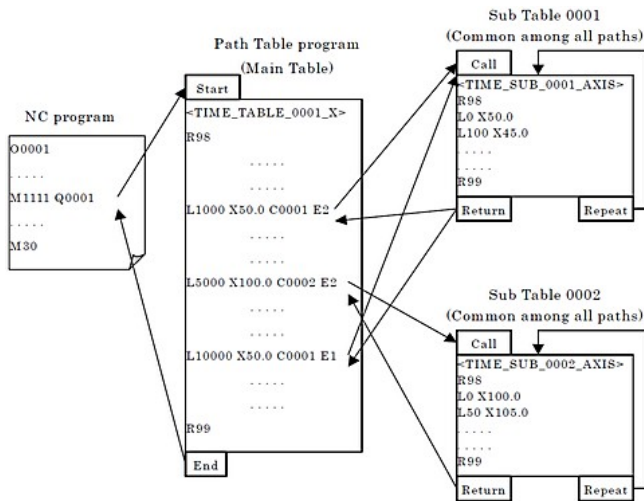

# Sub-Table Call for Path Table Operation

## Features

When the same shape is machined repeatedly in Path Table Operation (PTO), it can be separated as a Sub Table by this function.

A Sub Table can be called from Path Table programs (Main Table) in arbitrary paths. Moreover, it is possible to execute the same Sub Table repeatedly by specifying the repeat count when the Sub Table is called.

The function simplifies the way Path Table programs are made and also reduces the memory usage allocated to Path Table programs.

## Benefits

- Reduction of the memory usage allocated to Path Tables
- Simplifies the programming of repetitive operations
- Increase of the flexibility of Path Table Operation for complex systems
- Increase of the productivity of the machine

## Ordering Information

Specification	Description
A02B-0323-R618	30i-B Path Table Operation (PTO) - Sub Table Call
A02B-0326-R618	31i-B5 Path Table Operation (PTO) - Sub Table Call
A02B-0327-R618	31i-B Path Table Operation (PTO) - Sub Table Call

### Notice

Certain functions may require additional hardware, different CPU type or additional memory capacity or may cause compatibility issue with other functions. In case of doubt, contact your FANUC sales representative for additional information and support.

The information given in the FANUC manuals or original manufacturer documentation shall prevail. Technical data is subject to change without prior notice. No part of this document may be reproduced in any form. All rights reserved. © FANUC 2017

# 207

## Interpolation Functions

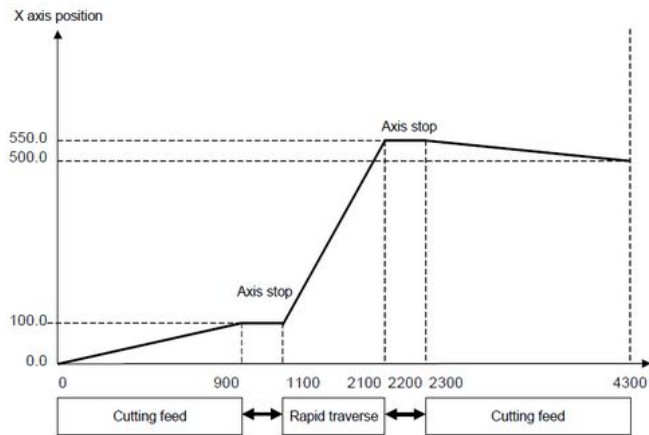

# Cutting / Rapid Switching Function for Path Table Operation

## Features

In a regular NC program, separate parameters can be used to define cutting feed and rapid traverse. The parameters are switched according to the state of cutting feed / rapid traverse.

In the standard Path Table Operation (PTO) mode, parameters cannot be switched between cutting feed and rapid traverse since only one cutting feed is supported.

In Path Table Operation mode, this function enables a switching between cutting feed and rapid traverse.

In path table operation, parameters such as backlash compensation can be switched because this function enables switching between cutting feed and rapid traverse. Both high-accuracy in cutting feed and high-speed in rapid traverse can be achieved as a consequence of an optimal parameter settings.

Cutting feed is specified by R60 command, and rapid traverse is specified by R61 command.

## Example of program

```
TIME_TABLE_0001_X
R98;
L0 X0.0;
L900 X100.0;
L1100 X100.0 R61;
L2100 X550.0;
L2300 X550.0 R60;
L4300 X500.0;
:
R99;
```

## Benefits

- Higher accuracy in Path Table Operation mode
- Decrease of the cycle time in Path Table Operation
- Overall increase of the productivity

### Notice

Certain functions may require additional hardware, different CPU type or additional memory capacity or may cause compatibility issue with other functions. In case of doubt, contact your FANUC sales representative for additional information and support.

The information given in the FANUC manuals or original manufacturer documentation shall prevail. Technical data is subject to change without prior notice. No part of this document may be reproduced in any form. All rights reserved. © FANUC 2017



## Ordering Information

Specification	Description
A02B-0323-R668	30i-B Path Table Operation (PTO) - Cutting / Rapid Switching Function
A02B-0326-R668	31i-B5 Path Table Operation (PTO) - Cutting / Rapid Switching Function
A02B-0327-R668	31i-B Path Table Operation (PTO) - Cutting / Rapid Switching Function

### Notice

Certain functions may require additional hardware, different CPU type or additional memory capacity or may cause compatibility issue with other functions. In case of doubt, contact your FANUC sales representative for additional information and support.

The information given in the FANUC manuals or original manufacturer documentation shall prevail. Technical data is subject to change without prior notice. No part of this document may be reproduced in any form. All rights reserved. © FANUC 2017

# 209

## Interpolation Functions

# Path Table Operation Execution Data Size 20Mbyte

## Features

This function expands the DRAM area size which stores the data for path table operation from 7 MB to 20 MB. This allows the operation of large path table programs.

## Benefits

- Expands the application range of the path table operation function

## Ordering Information

Specification	Description
A02B-0323-R727	30i-B Path Table Operation (PTO) - Path Table Executive Form Data Area Size 20 MB
A02B-0326-R727	31i-B5 Path Table Operation (PTO) - Path Table Executive Form Data Area Size 20 MB
A02B-0327-R727	31i-B Path Table Operation (PTO) - Path Table Executive Form Data Area Size 20 MB

### Notice

Certain functions may require additional hardware, different CPU type or additional memory capacity or may cause compatibility issue with other functions. In case of doubt, contact your FANUC sales representative for additional information and support.

The information given in the FANUC manuals or original manufacturer documentation shall prevail. Technical data is subject to change without prior notice. No part of this document may be reproduced in any form. All rights reserved. © FANUC 2017

# 210

## Interpolation Functions

PATH TABLE OPERATION HIST<LIST> 00123 N00000

DETECT TIME 2010/11/19 16:47:18		[PATH1] NO.3/3				
ALM P50451	DETAIL ALM 100	REF. TIME 4000.000000 us	TIME OVRD 100 %			
PATH TABLE INFORMATION						
AXIS	PATH TABLE NAME	CMD. REF.	REAL REF.	MACHINE		
X	TIME_TABLE_0041_X	4100.000000	4015.600000	400.000		
Y	AXIS_TABLE_0014_Y	450.000	401.560	98.000		
A	TIME_TABLE_0003_S3	3000.000000	4015.600000	0.000		
X12	SPDL_TABLE_0004_X12	360.000	2.800	267.640		
X13	TIME_TABLE_5001_X13	4200.000000	1800.000000	2391.287		
Y12	-	-	-	0.000		
C	TIME_TABLE_0001_S1	5000.000000	4015.600000	2.800		
Z	TIME_TABLE_0001_Z	5000.000000	4015.600000	-101.600		
M	TIME_TABLE_0011_M	4004.000000	4015.600000			
SPINDLE INFORMATION				M CODE		
SPINDLE	CMD. SPEED	REAL SPEED	SP. OVRD	CTRL. MODE	H	CODE
S1(C)	0	60	0 %	20	H	4001
S3(A)	0	0	0 %	30	H	4002

A>\_

EDIT **** * * *	12:00:00	PATH1	
<	LIST	DETAIL	(OPRT)

# Path Table Operation History Function

## Features

This function enables to save information related to path table operation as history data in the moment an alarm is issued. The saved history data can be displayed to a CNC screen and can be output to an external device. The data can be accessed by FOCAS2 library functions and C-language library functions. This function facilitates the investigation of an alarm cause that is issued during path table operation.

## Benefits

- Simplifies root cause investigation of failures and reduces down time

## Ordering Information

Specification	Description
A02B-0323-R525	30i-B Path Table Operation (PTO) - Path Table Operation History Function
A02B-0326-R525	31i-B5 Path Table Operation (PTO) - Path Table Operation History Function
A02B-0327-R525	31i-B Path Table Operation (PTO) - Path Table Operation History Function

## Notice

Certain functions may require additional hardware, different CPU type or additional memory capacity or may cause compatibility issue with other functions. In case of doubt, contact your FANUC sales representative for additional information and support.

The information given in the FANUC manuals or original manufacturer documentation shall prevail. Technical data is subject to change without prior notice. No part of this document may be reproduced in any form. All rights reserved. © FANUC 2017

# 211

## Interpolation Functions

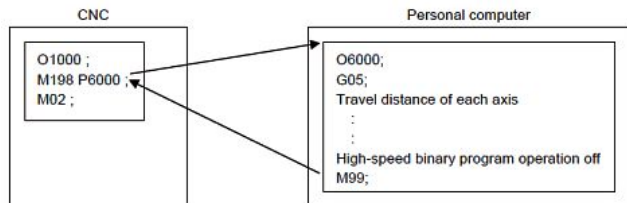

# High-Speed Binary Program Operation

## Features

The high-speed binary program operation is the function to execute an external program written in binary format and stored on an external device (Data Server or a Personal Computer connected to the CNC via HSSB).

DNC operation or external subprogram call (M198) can be used to use the function.

The number of axes, paths and the execution time depend on the CNC type and configuration. Refer to the function manual for additional information.

## Benefits

- Provides the capability to execute binary programs
- Possibility to transfer complex shapes and programs with high-speed to the CNC
- Improves overall machining productivity

## Ordering Information

Specification	Description
A02B-0323-R516	30i-B High-Speed Binary Mode Function (only 1 Path)
A02B-0326-R516	31i-B5 High-Speed Binary Mode Function (only 1 Path)
A02B-0327-R516	31i-B High-Speed Binary Mode Function (only 1 Path)

### Notice

Certain functions may require additional hardware, different CPU type or additional memory capacity or may cause compatibility issue with other functions. In case of doubt, contact your FANUC sales representative for additional information and support.

The information given in the FANUC manuals or original manufacturer documentation shall prevail. Technical data is subject to change without prior notice. No part of this document may be reproduced in any form. All rights reserved. © FANUC 2017

# 212

## Interpolation Functions

# High-Speed Binary Program Operation on 2-Path Control

---

## Features

This function allows to execute the high-speed binary program operation on 2 paths. It is possible to start the high-speed binary program operation on both paths at the same time.

## Benefits

- Expands the application range of the high-speed binary program operation function

## Ordering Information

Specification	Description
A02B-0323-S814	30i-B High-Speed Binary Program Operation on 2-Path Control
A02B-0326-S814	31i-B5 High-Speed Binary Program Operation on 2-Path Control
A02B-0327-S814	31i-B High-Speed Binary Program Operation on 2-Path Control

### Notice

Certain functions may require additional hardware, different CPU type or additional memory capacity or may cause compatibility issue with other functions. In case of doubt, contact your FANUC sales representative for additional information and support.

The information given in the FANUC manuals or original manufacturer documentation shall prevail. Technical data is subject to change without prior notice. No part of this document may be reproduced in any form. All rights reserved. © FANUC 2017

# 213

## Interpolation Functions

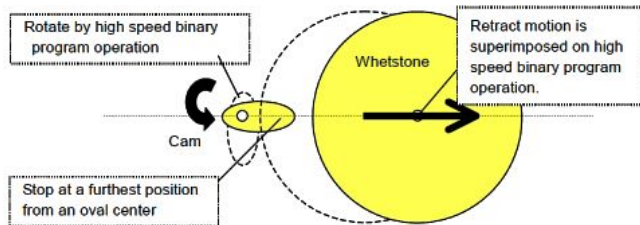

# High-Speed Binary Program Operation Retract Function

## Features

This function allows, in case of sudden and unexpected machine problem, to stop the machining process safely during the execution of high-speed binary program.

The retract operation is done on each axis when the retract signal is received during execution of the high speed binary program operation; it forces the high speed binary program operation to stop with a controlled deceleration. After this, the program is reset after retraction.

## Benefits

- Provides the capability to stop safely and smoothly a high-speed binary operation
- Improves the protection of tools and fixtures
- Improves overall machining productivity

## Ordering Information

Specification	Description
A02B-0323-S658	30i-B High-Speed Binary Program Operation Retract Function
A02B-0326-S658	31i-B5 High-Speed Binary Program Operation Retract Function
A02B-0327-S658	31i-B High-Speed Binary Program Operation Retract Function

### Notice

Certain functions may require additional hardware, different CPU type or additional memory capacity or may cause compatibility issue with other functions. In case of doubt, contact your FANUC sales representative for additional information and support.

The information given in the FANUC manuals or original manufacturer documentation shall prevail. Technical data is subject to change without prior notice. No part of this document may be reproduced in any form. All rights reserved. © FANUC 2017

# 214

## Interpolation Functions

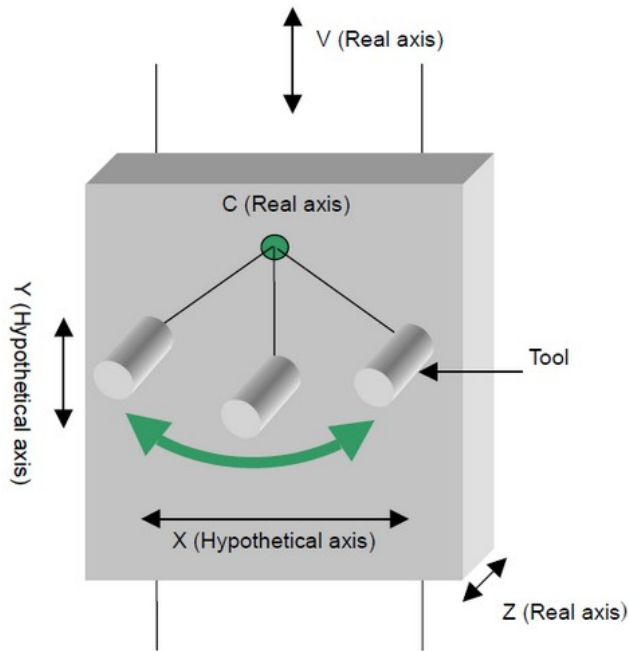

## Hypothetical Linear Axis Interpolation

### Features

With the Hypothetical Linear Axis Interpolation function, a machine having two linear axes and one rotary axis can be controlled as a normal X-Y-Z axes machine.

In this case, 3-dimensional positioning and interpolation functions are available. The linear axis not having a real axis becomes a hypothetical axis and it is necessary that hypothetical axis is set as one of CNC controlled axes.

### Example

On the figure, the machine pictured needs two hypothetical axes and three real axes, so the number of CNC control axes is five. X-Y-Z command in direct coordinate is available in the hypothetical axis command mode and the command for the real axis, for example V-Z-C command, is available in real axis command mode.

The hypothetical axis command mode signal IMMD provides the possibility to switch between the hypothetical axis command mode and real axis command mode. Both modes are effective in both automatic operation mode and manual mode. The rotation axis cannot be set to Cs contouring control axis.

### Benefits

- Simplifies the programming of complex machine configuration
- Overall increase of the machine productivity and efficiency

### Ordering Information

Specification	Description
A02B-0323-S968	30i-B Hypothetical Linear Axis Control Function
A02B-0326-S968	31i-B5 Hypothetical Linear Axis Control Function
A02B-0327-S968	31i-B Hypothetical Linear Axis Control Function

#### Notice

Certain functions may require additional hardware, different CPU type or additional memory capacity or may cause compatibility issue with other functions. In case of doubt, contact your FANUC sales representative for additional information and support.

The information given in the FANUC manuals or original manufacturer documentation shall prevail. Technical data is subject to change without prior notice. No part of this document may be reproduced in any form. All rights reserved. © FANUC 2017

# 215

## Interpolation Functions

# High-Speed and High-Quality Machining Package

## Features

This function is a package for the FANUC 0i-MF series that contains the relevant options suitable for high-speed and high-quality machining, particularly for die/mold machining. The following options are combined in the package:

- AI Contour Control II
- Smooth Tolerance Control
- Jerk Control
- Machining Quality Level Adjustment Function

## Benefits

- Select the necessary options for high-speed and high-quality machining easily

## Ordering Information

Specification	Description
A02B-0340-R660	0i-MF High-Speed and High-Quality Machining Package (Fine Mould Machining Package)

### Notice

Certain functions may require additional hardware, different CPU type or additional memory capacity or may cause compatibility issue with other functions. In case of doubt, contact your FANUC sales representative for additional information and support.

The information given in the FANUC manuals or original manufacturer documentation shall prevail. Technical data is subject to change without prior notice. No part of this document may be reproduced in any form. All rights reserved. © FANUC 2017



# 216

## Functions

## Feed Functions

---

This section of the catalogue contains the functions related to the CNC motion (feed functions) enabling the control of the movement of the axes in the machine.

Feed functions, like Advanced Preview Control, AI Contour Control I and II provide high-speed contouring capabilities. Acceleration / deceleration options protect the machine from the shocks of sudden starts and stops. They work in concert with the AI Contour Control functions to provide high-speed, high-precision machining capabilities.

Some of the feed functions detailed in the catalogue:

- Optimum torque acceleration / deceleration
- Positioning by optimum acceleration
- Bell-shaped acc / dec after cutting feed interpolation
- Advanced Preview Control
- AI Contour Control
- High Speed Processing
- Jerk Control
- Etc.

### Notice

Certain functions may require additional hardware, different CPU type or additional memory capacity or may cause compatibility issue with other functions. In case of doubt, contact your FANUC sales representative for additional information and support.

The information given in the FANUC manuals or original manufacturer documentation shall prevail. Technical data is subject to change without prior notice. No part of this document may be reproduced in any form. All rights reserved. © FANUC 2017

# 217

## Feed Functions

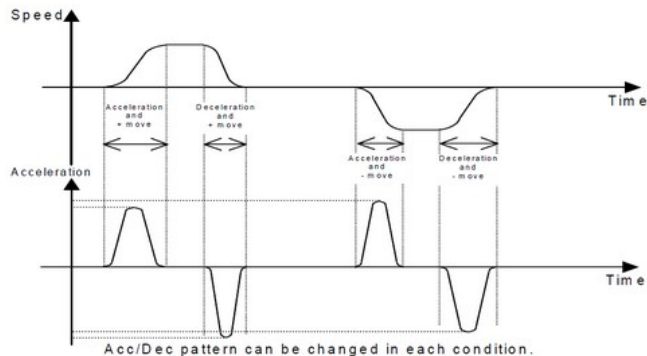

# Optimum Torque Acceleration/Deceleration

## Features

This Optimum Torque Acceleration / Deceleration function enables optimal Rapid Traverse acceleration / deceleration during AI Contour Control I (AICC-I), AI Contour Control II (AICC-II), AI High Precision Contour Control (AI HPCC) and AI Nano High Precision Contour Control (AI Nano HPCC) modes.

The machine axis friction, gravity, and servomotor characteristics all have an impact on the acceleration / deceleration performance of each machine axis. In addition, the servomotor torque required for axis acceleration / deceleration differs according to the axis movement direction and whether the axis is accelerating or decelerating.

With this function, it is possible to set appropriate CNC parameters defining individual axis direction-dependant acceleration and deceleration limits. During AICC-I, AICC-II, AI HPCC and AI NANO HPCC modes, the CNC automatically optimizes the rapid traverse acceleration and deceleration rates in accordance to these parameters settings, and the current direction and acceleration mode of the machine axes. The Optimum Torque Acceleration/ Deceleration function optimizes the capability of each motor / axis performance resulting in faster axis positioning (rapid traverse) and reduced overall cycle time.

## Benefits

- Optimization of the rapid traverse performance of each axis
- Reduction of the axis positioning time and overall machining time.
- Overall improvement of the machining productivity

## Ordering Information

Specification	Description
A02B-0323-S675	30i-B Optimum Torque Acceleration/Deceleration.
A02B-0326-S675	31i-B5 Optimum Torque Acceleration/Deceleration.
A02B-0327-S675	31i-B Optimum Torque Acceleration/Deceleration.
A02B-0328-S675	32i-B Optimum Torque Acceleration/Deceleration.
A02B-0339-S675	0i-TF Optimum Torque Acceleration / Deceleration
A02B-0340-S675	0i-MF Optimum Torque AccelerationDeceleration

### Notice

Certain functions may require additional hardware, different CPU type or additional memory capacity or may cause compatibility issue with other functions. In case of doubt, contact your FANUC sales representative for additional information and support.

The information given in the FANUC manuals or original manufacturer documentation shall prevail. Technical data is subject to change without prior notice. No part of this document may be reproduced in any form. All rights reserved. © FANUC 2017

# 218

## Feed Functions

# Positioning by Optimum Acceleration

## Features

When a rapid traverse command is specified during automatic operation, the Positioning by Optimum Acceleration function can be used to adjust the rapid traverse rate, time constant, and loop gain, according to the amount of travel for the block.

This reduces the time required for positioning and position check, therefore reducing the overall cycle time.

## Benefits

- Optimization of rapid traverse (G00) positioning
- Reduction of machining cycle time
- Improvement of the productivity of the machine

## Ordering Information

Specification	Description
A02B-0323-J693	30i-B Positioning by Optimal Acceleration
A02B-0326-J693	31i-B5 Positioning by Optimal Acceleration
A02B-0327-J693	31i-B Positioning by Optimal Acceleration
A02B-0328-J693	32i-B Positioning by Optimal Acceleration
A02B-0333-J693	35i-B Positioning by Optimal Acceleration
A02B-0334-J693	PM i-A Positioning by Optimal Acceleration
A02B-0339-J693	0i-TF Positioning by Optimum Acceleration
A02B-0340-J693	0i-MF Positioning by Optimum Acceleration

### Notice

Certain functions may require additional hardware, different CPU type or additional memory capacity or may cause compatibility issue with other functions. In case of doubt, contact your FANUC sales representative for additional information and support.

The information given in the FANUC manuals or original manufacturer documentation shall prevail. Technical data is subject to change without prior notice. No part of this document may be reproduced in any form. All rights reserved. © FANUC 2017

# 219

## Feed Functions

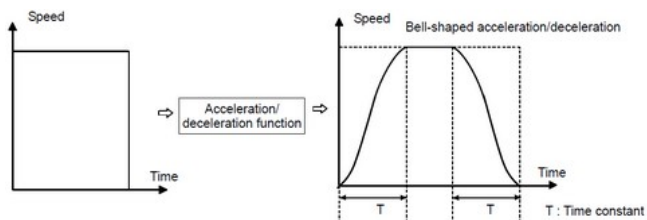

# Bell-Shaped Acc./Dec. After Cutting Feed Interpolation

## Features

The Bell-Shaped Acceleration / Deceleration after Cutting Feed Interpolation function is using bell-shaped cutting feedrate acceleration and deceleration profiles to reduce shock to the machine tool structure; it helps to eliminate vibration at the machine cutting point.

When applying bell-shaped acceleration, for a given acceleration rate, the overall time to accelerate to the programmed feedrate is generally shorter as compared to using the alternative linear or exponential acceleration profiles.

Any axes velocity changes (acc/dec) are applied AFTER the CNC has calculated the necessary velocity commands required for axes positioning.

This function is a basic function in FANUC Series 0i-F.

## Benefits

- Improvement of the surface finish
- Reduction of shock to the machine tool and any consequential disturbance at the machine cutting point.
- Reduction of overall acceleration times compared to the equivalent linear or exponential acceleration profile.
- Reduction of position error due to servo delay compared to the equivalent exponential acceleration profile.
- Improvement of the machine productivity

## Ordering Information

Specification	Description
A02B-0323-J829	30i-B Bell-Shaped Acceleration/Deceleration after Cutting Feed Interpolation
A02B-0326-J829	31i-B5 Bell-Shaped Acceleration/Deceleration after Cutting Feed Interpolation
A02B-0327-J829	31i-B Bell-Shaped Acceleration/Deceleration after Cutting Feed Interpolation
A02B-0328-J829	32i-B Bell-Shaped Acceleration/Deceleration after Cutting Feed Interpolation

### Notice

Certain functions may require additional hardware, different CPU type or additional memory capacity or may cause compatibility issue with other functions. In case of doubt, contact your FANUC sales representative for additional information and support.

The information given in the FANUC manuals or original manufacturer documentation shall prevail. Technical data is subject to change without prior notice. No part of this document may be reproduced in any form. All rights reserved. © FANUC 2017

# 220

## Feed Functions

## 2nd Feedrate Override

---

### Features

The Second Feedrate Override function allows cutting feedrates that have been overridden once to be overridden a second time.

The override is done in a percentage from 0 to 254% in increments of 1%. The value is set from the PMC. No override can be performed on functions such as threading and tapping in which override is inhibited. This function is used for controlling feedrate in adaptive control, etc.

### Benefits

- Adds additional override capabilities to the CNC
- Simplifies programming
- Improves overall machining productivity

### Ordering Information

Specification	Description
A02B-0323-J810	30i-B 2nd Feedrate Override
A02B-0326-J810	31i-B5 2nd Feedrate Override
A02B-0327-J810	31i-B 2nd Feedrate Override
A02B-0328-J810	32i-B 2nd Feedrate Override
A02B-0333-J810	35i-B 2nd Feedrate Override
A02B-0339-J810	0i-TF 2nd Feedrate Override
A02B-0340-J810	0i-MF 2nd Feedrate Override

#### Notice

Certain functions may require additional hardware, different CPU type or additional memory capacity or may cause compatibility issue with other functions. In case of doubt, contact your FANUC sales representative for additional information and support.

The information given in the FANUC manuals or original manufacturer documentation shall prevail. Technical data is subject to change without prior notice. No part of this document may be reproduced in any form. All rights reserved. © FANUC 2017

# 221

## Feed Functions

# One-Digit F-Code Feed

## Features

The One-Digit F-Code Feed function provides the ability to preset 9 feed rates that are stored in parameters and activated by programming F1 through F9.

The feed rate corresponding to the specified number is set. When F0 is commanded, rapid traverse rate is set. If the manual pulse generator is rotated with the one-digit F code feed selection signal set to 1, the feed rate corresponding to the currently selected number is increased or decreased. A set or modified feed rate is preserved while the power is turned off.

The current feed rate is displayed on the screen.

This function is a basic function in FANUC Series 0i-MF.

## Benefits

- Adds preset capabilities to manage/control easily feedrates sets to the CNC
- Simplifies programming
- Improves overall machining productivity

## Ordering Information

Specification	Description
A02B-0323-J820	30i-B F1 Digit Feed
A02B-0326-J820	31i-B5 F1 Digit Feed
A02B-0327-J820	31i-B F1 Digit Feed
A02B-0328-J820	32i-B F1 Digit Feed

### Notice

Certain functions may require additional hardware, different CPU type or additional memory capacity or may cause compatibility issue with other functions. In case of doubt, contact your FANUC sales representative for additional information and support.

The information given in the FANUC manuals or original manufacturer documentation shall prevail. Technical data is subject to change without prior notice. No part of this document may be reproduced in any form. All rights reserved. © FANUC 2017

# 222

## Feed Functions

# Inverse Time Feed

## Features

The G code for inverse time feed is a modal G code and belongs to group 05 (includes G code for feed per revolution and G code for feed per minute). The Inverse Time Feed function (G93 mode) allows the feedrate of the tool to be specified by the move distance of the block and inverse time (FRN) where:

- Linear interpolation (G01)  
FRN=1/Time (min) = Speed/Distance  
Speed: mm/ min (metric input), inch/ min (inch input)  
Distance: mm (metric input), inch (inch input)
- Circular interpolation (G02, G03)  
FRN=1/Time (min) = Speed/Circle radius  
Speed: mm/ min (metric input), inch/ min (inch input)  
Circle radius: mm (metric input), inch (inch input)

This function is a basic function in FANUC Series 0i-MF.

## Benefits

- Adds inverse time capabilities to the CNC
- Simplifies programming
- Improves overall machining productivity

## Ordering Information

Specification	Description
A02B-0323-J715	30i-B Inverse Time Feed
A02B-0326-J715	31i-B5 Inverse Time Feed
A02B-0327-J715	31i-B Inverse Time Feed
A02B-0328-J715	32i-B Inverse Time Feed

### Notice

Certain functions may require additional hardware, different CPU type or additional memory capacity or may cause compatibility issue with other functions. In case of doubt, contact your FANUC sales representative for additional information and support.

The information given in the FANUC manuals or original manufacturer documentation shall prevail. Technical data is subject to change without prior notice. No part of this document may be reproduced in any form. All rights reserved. © FANUC 2017

# 223

## Feed Functions

### Rate Feed

#### Features

This function enables to continually increase / decrease (linear) the feedrate within a block. While considering the feedrate of the previous block as the start value and specifying the value of the feedrate at the end of the block, the feedrate is changed linearly from start value to the end value within the block commanded.

Example of application

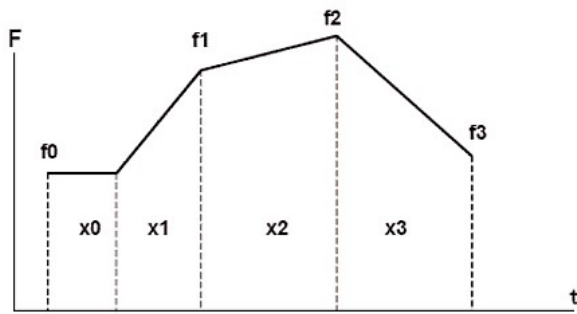

```
N10 G01 Xx0 Ff0 ;  
N20 G93.2 Xx1 Ff1 ;  
N30 Xx2 Ff2 ;  
N40 Xx3 Ff3 ;
```

with Rate Feed Function



without Rate Feed Function

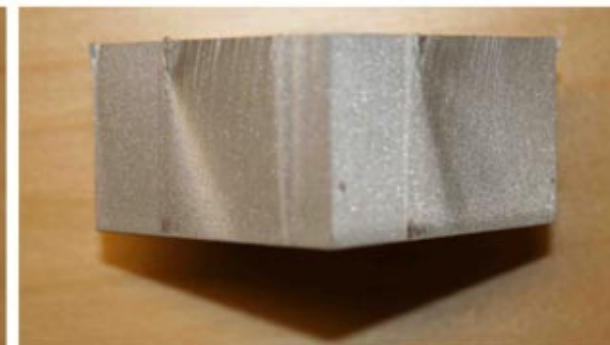
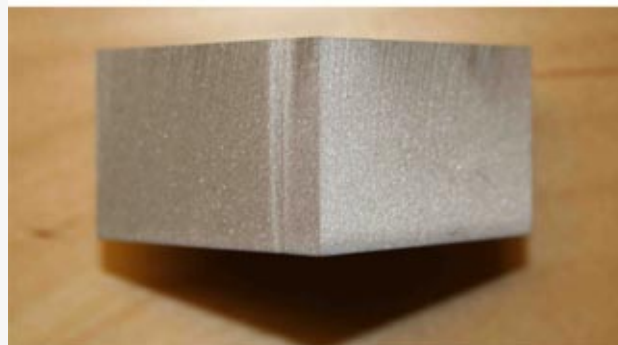

#### Notice

Certain functions may require additional hardware, different CPU type or additional memory capacity or may cause compatibility issue with other functions. In case of doubt, contact your FANUC sales representative for additional information and support.

The information given in the FANUC manuals or original manufacturer documentation shall prevail. Technical data is subject to change without prior notice. No part of this document may be reproduced in any form. All rights reserved. © FANUC 2017



On water jet cutting machines, the water jet following error is essential to smoothly adjust the feedrate / to take corners and thus improve the cutting behaviour. Without this function it would be necessary to command a lot of tiny blocks to adapt the feedrate profile as needed.

## Benefits

- Possibility to program continuously smooth speed characteristics depending on the curvature of the workpiece to be machined
- Improvement of the cutting behaviour for water jet applications
- Improvement of the slide motion resulting in better part quality for press forming applications
- Improvement of the overall machining productivity

## Ordering Information

Specification	Description
A02B-0323-R635	30i-B Rate Feed Function
A02B-0326-R635	31i-B5 Rate Feed Function
A02B-0327-R635	31i-B Rate Feed Function
A02B-0328-R635	32i-B Rate Feed Function

### Notice

Certain functions may require additional hardware, different CPU type or additional memory capacity or may cause compatibility issue with other functions. In case of doubt, contact your FANUC sales representative for additional information and support.

The information given in the FANUC manuals or original manufacturer documentation shall prevail. Technical data is subject to change without prior notice. No part of this document may be reproduced in any form. All rights reserved. © FANUC 2017

# 225

## Feed Functions

# External Deceleration

## Features

The External Deceleration function provides the ability for the PMC to decelerate a controlled axis.

The feed rate is decelerated by external deceleration signals from the machine. The deceleration rate is set by parameters. External deceleration signals are provided for each axis and direction. Three types of deceleration condition settings can be dynamically selected by the PMC.

External deceleration can be applied to the rapid traverse rate, cutting feed rate, and manual handle feed rate.

This function is a basic function in FANUC Series 0i-F.

## Benefits

- Addition of controlled deceleration profiles to the CNC
- Simplifies programming
- Improves overall machining productivity

## Ordering Information

Specification	Description
A02B-0323-J842	30i-B External Deceleration
A02B-0326-J842	31i-B5 External Deceleration
A02B-0327-J842	31i-B External Deceleration
A02B-0328-J842	32i-B External Deceleration
A02B-0333-J842	35i-B External Deceleration
A02B-0334-J842	PM i-A External Deceleration

### Notice

Certain functions may require additional hardware, different CPU type or additional memory capacity or may cause compatibility issue with other functions. In case of doubt, contact your FANUC sales representative for additional information and support.

The information given in the FANUC manuals or original manufacturer documentation shall prevail. Technical data is subject to change without prior notice. No part of this document may be reproduced in any form. All rights reserved. © FANUC 2017

# 226

## Feed Functions

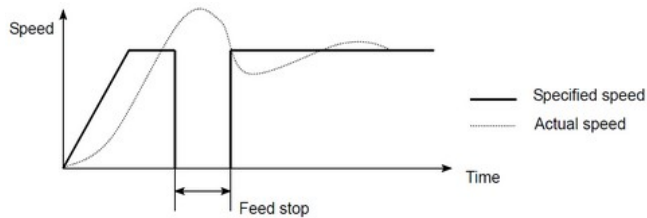

## Feed Stop

### Features

The Feed Stop function can avoid shocks to the machine, caused by the overshoot of a large servo motor accelerating in rapid traverse mode.

During axis motion, the feed stop function checks a position deviation amount continuously. When the amount exceeds the "feed stop position deviation amount", the function suspends pulse distribution and acceleration / deceleration control during such a period of time, and terminates the move command for the positioning control circuit.

Thus the function can minimize any overshoot that may occur with a large servo motor in rapid traverse acceleration operation.

### Benefits

- Reduction of the shocks to machine and process
- Improvement of the overall machining productivity

### Ordering Information

Specification	Description
A02B-0323-J847	30i-B Feed Stop
A02B-0326-J847	31i-B5 Feed Stop
A02B-0327-J847	31i-B Feed Stop
A02B-0328-J847	32i-B Feed Stop

#### Notice

Certain functions may require additional hardware, different CPU type or additional memory capacity or may cause compatibility issue with other functions. In case of doubt, contact your FANUC sales representative for additional information and support.

The information given in the FANUC manuals or original manufacturer documentation shall prevail. Technical data is subject to change without prior notice. No part of this document may be reproduced in any form. All rights reserved. © FANUC 2017

# 227

## Feed Functions

# Feedrate Control with Acceleration in Circular Interpolation

## Features

When high-speed cutting is performed in circular, helical or spiral interpolation, the actual tool path has an error with respect to the programmed path.

The feedrate of circular interpolation is automatically clamped by the permissible acceleration specified by the parameter for decreasing the shape error of radius direction.

This function is a basic function in FANUC Series 0i-MF and 0i-PF. It is included in AI Contour Control I or II in Series 0i-TF.

## Benefits

- Diminution of the tool-path error in circular, helical and spiral interpolation
- Simplification of the programming
- Improvement of the overall machining productivity

## Ordering Information

Specification	Description
A02B-0323-J809	30i-B Speed Control with Acceleration in Circular Interpolation
A02B-0326-J809	31i-B5 Speed Control with Acceleration in Circular Interpolation
A02B-0327-J809	31i-B Speed Control with Acceleration in Circular Interpolation
A02B-0328-J809	32i-B Speed Control with Acceleration in Circular Interpolation
A02B-0334-J809	PM i-A Speed Control with Acceleration in Circular Interpolation

### Notice

Certain functions may require additional hardware, different CPU type or additional memory capacity or may cause compatibility issue with other functions. In case of doubt, contact your FANUC sales representative for additional information and support.

The information given in the FANUC manuals or original manufacturer documentation shall prevail. Technical data is subject to change without prior notice. No part of this document may be reproduced in any form. All rights reserved. © FANUC 2017

# 228

## Feed Functions

# Advanced Preview Control

## Features

The Advanced Preview Control function is designed for high-speed precise machining. With this function, the delay due to acceleration / deceleration and the delay in the servo system that increases as the feed rate becomes higher can be suppressed.

The tool can then follow specified values accurately and errors in the machining profile can be reduced. In advanced preview control mode, the following functions are available:

- Linear acceleration / deceleration before interpolation
- Automatic corner deceleration function

This function is a basic function in FANUC Series 0i-MF and 0i-PF.

## Benefits

- Optimization of the machining speed using smooth acceleration / deceleration to minimize axis-overshoot errors.
- Decrease of the part-form tolerances suppressing acceleration / deceleration delays and servo lag
- Elimination of corner-clipping errors that typically increase as the feedrate increases

## Ordering Information

Specification	Description
A02B-0333-R678	35i-B Advanced Preview Control
A02B-0334-R678	PM i-A Advanced Preview Control

### Notice

Certain functions may require additional hardware, different CPU type or additional memory capacity or may cause compatibility issue with other functions. In case of doubt, contact your FANUC sales representative for additional information and support.

The information given in the FANUC manuals or original manufacturer documentation shall prevail. Technical data is subject to change without prior notice. No part of this document may be reproduced in any form. All rights reserved. © FANUC 2017

# 229

## Feed Functions

# AI Contour Control I

## Features

AI Contour Control I (AICC-I) is used to realize high-precision machining at optimal machining speeds. This function suppresses path errors due to acceleration / deceleration delay, servo positioning delay, and mechanical and electro-mechanical machine performance constraints.

Without this function machining profile errors would increase proportionally with the programmed path feedrate.

In practice, this function is useful when cutting on complex part forms involving sudden cutter direction changes such as are found in die/mold machining.

## Benefits

- Optimization of the machining speeds using smooth acceleration / deceleration to minimize axis-overshoot errors.
- Decrease of the part-form tolerances suppressing acceleration / deceleration delays and servo lag
- Elimination of corner-clipping errors that typically increase as the feedrate increases

## Ordering Information

Specification	Description
A02B-0323-S807	30i-B AI Contour Control I - Includes 30 Look-Ahead Blocks
A02B-0326-S807	31i-B5 AI Contour Control I - Includes 30 Look-Ahead Blocks
A02B-0327-S807	31i-B AI Contour Control I - Includes 30 Look-Ahead Blocks
A02B-0328-S807	32i-B AI Contour Control I - Includes 30 Look-Ahead Blocks
A02B-0339-J665	0i-TF AI Contour Control I
A02B-0340-J665	0i-MF AI Contour Control I

### Notice

Certain functions may require additional hardware, different CPU type or additional memory capacity or may cause compatibility issue with other functions. In case of doubt, contact your FANUC sales representative for additional information and support.

The information given in the FANUC manuals or original manufacturer documentation shall prevail. Technical data is subject to change without prior notice. No part of this document may be reproduced in any form. All rights reserved. © FANUC 2017

# 230

## Feed Functions

# AI Contour Control II

## Features

AI Contour Control II is used to enable high-precision machining at optimal machining speeds. This function suppresses path errors due to acceleration / deceleration delay, servo positioning delay, and mechanical and electro-mechanical machine performance constraints.

Without this function, machining profile errors would increase proportionally with the programmed path feedrate. In practice, this function is useful when cutting on complex part forms involving sudden cutter direction changes such as are found in die / mold machining.

## Benefits

- Optimization of machining speeds using smooth acceleration / deceleration to minimize axis-overshoot errors
- Decrease of part-form tolerances suppressing acceleration / deceleration delays and servo lag
- Elimination of corner-clipping errors that typically increase as the feedrate increases.

## Ordering Information

Specification	Description
A02B-0323-S808	30i-B AI Contour Control II - Includes 200 Look-Ahead Blocks
A02B-0326-S808	31i-B5 AI Contour Control II - Includes 200 Look-Ahead Blocks
A02B-0327-S808	31i-B AI Contour Control II - Includes 200 Look-Ahead Blocks
A02B-0328-S808	32i-B AI Contour Control II - Includes 200 Look-Ahead Blocks
A02B-0339-S808	0i-TF AI Contour Control II
A02B-0340-S808	0i-MF AI Contour Control II

### Notice

Certain functions may require additional hardware, different CPU type or additional memory capacity or may cause compatibility issue with other functions. In case of doubt, contact your FANUC sales representative for additional information and support.

The information given in the FANUC manuals or original manufacturer documentation shall prevail. Technical data is subject to change without prior notice. No part of this document may be reproduced in any form. All rights reserved. © FANUC 2017

# 231

## Feed Functions

# Look-Ahead Blocks Expansion of AI Contour Control II

## Features

This function expands the number of look-ahead blocks for AI contour control II from 200 blocks to 400 blocks. This function cannot be specified together with the high-speed processing option.

## Benefits

- Enables high-precision machining on cutting complex part-forms that are defined by many, tiny, program blocks such as are found in die/mold machining.
- The more look-ahead blocks the control can preview, the greater the chance it has of predicting a cutter direction change.

## Ordering Information

Specification	Description
A02B-0323-R468	30i-B Look-Ahead Blocks Expansion of AI Contour Control II - Expands Look-Ahead Blocks from 200 Blocks to 400 Blocks
A02B-0326-R468	31i-B5 Look-Ahead Blocks Expansion of AI Contour Control II - Expands Look-Ahead Blocks from 200 Blocks to 400 Blocks
A02B-0327-R468	31i-B Look-Ahead Blocks Expansion of AI Contour Control II - Expands Look-Ahead Blocks from 200 Blocks to 400 Blocks
A02B-0328-R468	32i-B Look-Ahead Blocks Expansion of AI Contour Control II - Expands Look-Ahead Blocks from 200 Blocks to 400 Blocks

### Notice

Certain functions may require additional hardware, different CPU type or additional memory capacity or may cause compatibility issue with other functions. In case of doubt, contact your FANUC sales representative for additional information and support.

The information given in the FANUC manuals or original manufacturer documentation shall prevail. Technical data is subject to change without prior notice. No part of this document may be reproduced in any form. All rights reserved. © FANUC 2017



# 232

## Feed Functions

# High-Speed Processing

---

## Features

The High-Speed Processing function improves both the CNC Block Processing Time and the NC block look-ahead capability of the option AI Contour Control II.

## Benefits

- Enables higher precision machining of complex free-form surfaces described by minute micro-block moves.
- Optimization of the machining speed of complex free-form surfaces described by minute micro-block moves.

## Ordering Information

Specification	Description
A02B-0323-S809	30i-B High-Speed Processing - Includes Look-Ahead Blocks Expansion - from 200 Blocks to 600 Blocks
A02B-0326-S809	31i-B5 High-Speed Processing - Includes Look-Ahead Blocks Expansion - from 200 Blocks to 600 Blocks
A02B-0327-S809	31i-B High-Speed Processing - Includes Look-Ahead Blocks Expansion - from 200 Blocks to 600 Blocks

### Notice

Certain functions may require additional hardware, different CPU type or additional memory capacity or may cause compatibility issue with other functions. In case of doubt, contact your FANUC sales representative for additional information and support.

The information given in the FANUC manuals or original manufacturer documentation shall prevail. Technical data is subject to change without prior notice. No part of this document may be reproduced in any form. All rights reserved. © FANUC 2017

# 233

## Feed Functions

# Look-Ahead Blocks Expansion

## Features

When performing High-Speed Processing with AI Contour Control II, this function expands the CNC look-ahead capability to 1,000 CNC Part Program Blocks.

## Benefits

- Enables a higher-precision machining on cutting complex part-forms that are defined by many, tiny, program blocks such as are found in die/mold machining.
- The more look-ahead blocks the control can preview, the greater the chance it has of predicting a cutter direction change.

## Ordering Information

Specification	Description
A02B-0323-S815	30i-B Look-Ahead Blocks Expansion - Expands Number of Look-Ahead Blocks from 600 Blocks to 1000 Blocks
A02B-0326-S815	31i-B5 Look-Ahead Blocks Expansion - Expands Look-Ahead Blocks from 600 Blocks to 1000 Blocks
A02B-0327-S815	31i-B Look-Ahead Blocks Expansion - Expands Look-Ahead Blocks from 600 Blocks to 1000 Blocks

### Notice

Certain functions may require additional hardware, different CPU type or additional memory capacity or may cause compatibility issue with other functions. In case of doubt, contact your FANUC sales representative for additional information and support.

The information given in the FANUC manuals or original manufacturer documentation shall prevail. Technical data is subject to change without prior notice. No part of this document may be reproduced in any form. All rights reserved. © FANUC 2017

# 234

## Feed Functions

Linear interpolation (N1) → circular interpolation (N2)

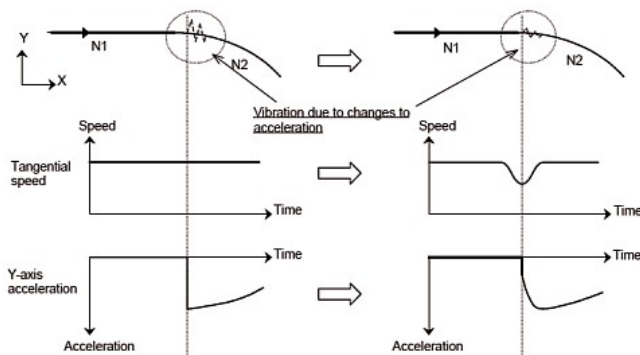

# Jerk Control

## Features

Whereas the rate-of-change of velocity is referred to as Acceleration, the rate-of-change of acceleration is technically known as Jerk. Jerk is therefore the third derivative of Position, with Acceleration the second and Velocity the first.

Wherever a part program causes a significant change in cutter-path direction, such as in a transition from a straight line to curve, any axis acceleration that is required to maintain a constant cutter-path vector feedrate through that transition may cause vibration or shock to be induced into the machine structure.

The Jerk Control function can be used to reduce shock and any resultant position error from sudden axis acceleration. Jerk Control temporarily modifies the cutter-path vector feedrate by applying a smoothing effect progressively modifying the rate-of-change of acceleration (Jerk).

Without using Jerk Control, Bell-Shaped Acceleration alone would apply a harsher, constant rate-of-change, acceleration profile. The permissible rate-of-change of acceleration (Jerk) is set by CNC parameters for each machine axis; these limits are usually set in advance by the machine-tool-builder. Any velocity adjustments applied by the Jerk Control function are calculated as true positional commands and hence incur only minimal acceleration or deceleration delays (Acc/Dec Before Interpolation).

## Benefits

- Reduction of machining errors caused by shock and vibration induced into the machine structure that result of sudden changes in axis acceleration

## Ordering Information

Specification	Description
A02B-0323-S678	30i-B Jerk Control
A02B-0326-S678	31i-B5 Jerk Control
A02B-0327-S678	31i-B Jerk Control
A02B-0328-S678	32i-B Jerk Control
A02B-0340-S678	0i-MF Jerk Control

### Notice

Certain functions may require additional hardware, different CPU type or additional memory capacity or may cause compatibility issue with other functions. In case of doubt, contact your FANUC sales representative for additional information and support.

The information given in the FANUC manuals or original manufacturer documentation shall prevail. Technical data is subject to change without prior notice. No part of this document may be reproduced in any form. All rights reserved. © FANUC 2017

# 235

## Feed Functions

# Rigid Tapping with Bell-Shaped Acceleration/Deceleration

---

## Features

Linear acceleration / deceleration and exponential acceleration / deceleration (for milling / M type only) have conventionally been used to realized to rigid tapping.

Using bell shaped acceleration / deceleration enables a machine-friendly tapping. The use of smaller time constants for the tapping cycle is required by the fact that the time required for acceleration / deceleration is shorter than with linear profile.

Since this bell shaped acceleration / deceleration is a rapid traverse bell shaped type, parameters are used to specify a linear acceleration / deceleration time constant and the time for a bell shaped curved section.

Note: in three-dimensional rigid tapping, bell-shaped acceleration/deceleration is disabled, and linear acceleration / deceleration is applied.

This function is a basic function in FANUC Series 0i-MF and 0i-TF.

## Benefits

- Smoother movements during tapping operation
- Diminution of the wear of tools and mechanical structure
- Improvement of the overall machining productivity

## Ordering Information

Specification	Description
A02B-0323-S702	30i-B Rigid Tapping Bell-Shaped Acceleration/Deceleration
A02B-0326-S702	31i-B5 Rigid Tapping Bell-Shaped Acceleration/Deceleration
A02B-0327-S702	31i-B Rigid Tapping Bell-Shaped Acceleration/Deceleration
A02B-0328-S702	32i-B Rigid Tapping Bell-Shaped Acceleration/Deceleration
A02B-0333-S702	35i-B Rigid Tapping Bell-Shaped Acceleration/Deceleration

### Notice

Certain functions may require additional hardware, different CPU type or additional memory capacity or may cause compatibility issue with other functions. In case of doubt, contact your FANUC sales representative for additional information and support.

The information given in the FANUC manuals or original manufacturer documentation shall prevail. Technical data is subject to change without prior notice. No part of this document may be reproduced in any form. All rights reserved. © FANUC 2017

# 236

## Feed Functions

# Optimum Torque Acceleration/Deceleration for Rigid Tapping

## Features

The Optimum Torque Acceleration / Deceleration for Rigid Tapping function can flexibly set the acceleration and deceleration of the cutting in the rigid tapping according to the torque characteristic of the spindle motor and the machine characteristic such as the friction.

The acceleration and deceleration performance (hereafter the maximum acceleration line) which can be output is usually not symmetric in a low-speed part and a high-speed part because of the torque characteristic of the spindle motor and the machine characteristic.

The conventional acceleration and deceleration (linear / bell-shaped) has a symmetric acceleration and deceleration. The acceleration/deceleration of this function is realized so that the real acceleration pattern may approach the maximum acceleration line as much as possible. The performance of the motor is drawn out to its maximum by this, and the cutting time can be shortened.

However, when the rigid tapping is used in an acceleration constant range of the spindle motor, shortening the cutting time cannot be expected. It is possible to execute the rigid tapping with the acceleration and deceleration along the maximum acceleration line by setting the acceleration line pattern in the parameter of each gear. The acceleration and deceleration of pulling out uses the same acceleration line pattern as them of the cutting.

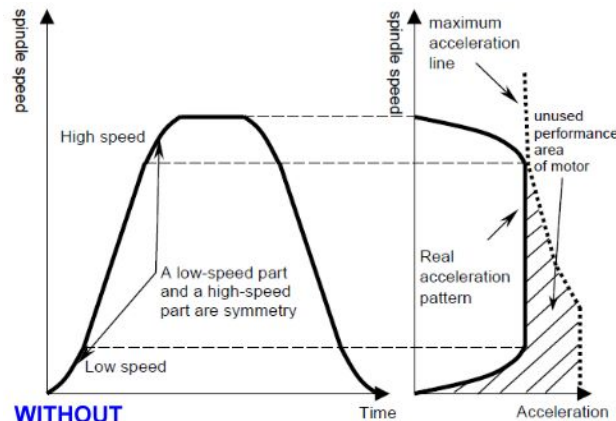

WITHOUT

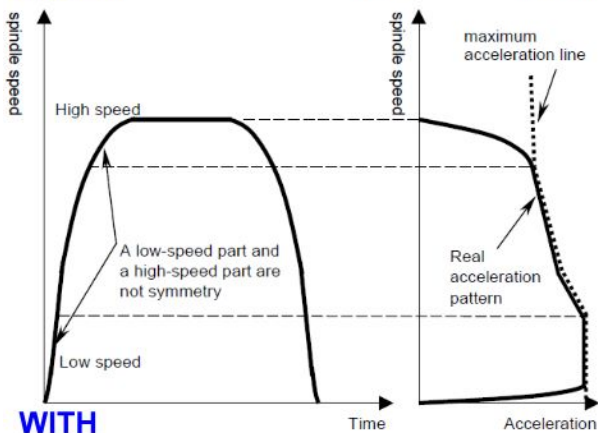

WITH

### Notice

Certain functions may require additional hardware, different CPU type or additional memory capacity or may cause compatibility issue with other functions. In case of doubt, contact your FANUC sales representative for additional information and support.

The information given in the FANUC manuals or original manufacturer documentation shall prevail. Technical data is subject to change without prior notice. No part of this document may be reproduced in any form. All rights reserved. © FANUC 2017

## Benefits

- Optimization of the rigid tapping processing
- Increase of the tapping and cutting performance of the machine
- Increase of the overall productivity of the machine

## Ordering Information

Specification	Description
A02B-0323-R533	30i-B Optimum Acceleration/Deceleration for Rigid Tapping
A02B-0326-R533	31i-B5 Optimum Acceleration/Deceleration for Rigid Tapping
A02B-0327-R533	31i-B Optimum Acceleration/Deceleration for Rigid Tapping
A02B-0328-R533	32i-B Optimum Acceleration/Deceleration for Rigid Tapping
A02B-0333-R533	35i-B Optimum Acceleration/Deceleration for Rigid Tapping
A02B-0339-R533	0i-TF Optimum Acceleration / Deceleration for Rigid Tapping
A02B-0340-R533	0i-MF Optimum Acceleration / Deceleration for Rigid Tapping

# 237

## Feed Functions

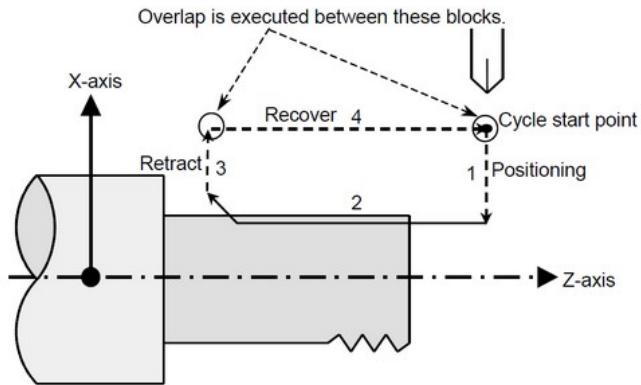

# Programmable Rapid Traverse Overlap

## Features

Rapid Traverse Overlap function reduces cycle time by starting the next rapid traverse block before the previous rapid traverse block ends, when continuous blocks with rapid traverse command are given.

Here is an overview to the two added functions of Programmable Rapid Traverse Overlap:

- Programmable rapid traverse overlap: the amount of rapid traverse overlap can be changed by setting the feed rate reduction ratio to a system variable in a part program. This enables an optimal overlapping effect for each rapid traverse path of the machining program.
- Rapid traverse overlap between threading cycle blocks: shortened cycle times become possible by overlapping rapid traverse blocks during the threading cycle. As shown in the right figure, rapid traverse overlap is executed between "3.Retract and 4.Return" and between "4.Return and 1.Positioning".

## Benefits

- Optimization of the cycle time of high volume production machines
- Improvement of the overall machining productivity

## Ordering Information

Specification	Description
A02B-0323-R502	30i-B Programmable Rapid Traverse Overlap
A02B-0326-R502	31i-B5 Programmable Rapid Traverse Overlap
A02B-0327-R502	31i-B Programmable Rapid Traverse Overlap
A02B-0328-R502	32i-B Programmable Rapid Traverse Overlap
A02B-0333-R502	35i-B Programmable Rapid Traverse Overlap
A02B-0334-R502	PM i-A Programmable Rapid Traverse Overlap
A02B-0339-R502	0i-TF Programmable Rapid Traverse Overlap
A02B-0340-R502	0i-MF Programmable Rapid Traverse Overlap

### Notice

Certain functions may require additional hardware, different CPU type or additional memory capacity or may cause compatibility issue with other functions. In case of doubt, contact your FANUC sales representative for additional information and support.

The information given in the FANUC manuals or original manufacturer documentation shall prevail. Technical data is subject to change without prior notice. No part of this document may be reproduced in any form. All rights reserved. © FANUC 2017

# 238

## Feed Functions

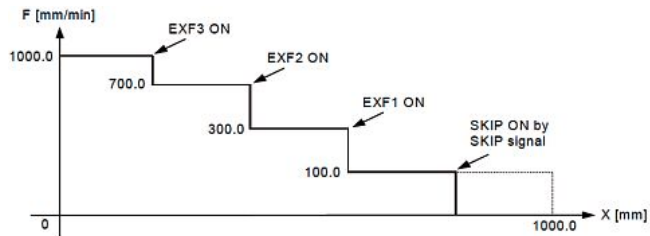

## Feedrate Change Function

### Features

With Feed Rate Change function, when an external signal is input, the cutting feed rate of G31 and G01 is changed to the value which is set by a parameter.

### Program example (mm input)

```
G31 X1000.0 F1000.0;
```

```
M30;
```

### Parameters:

- No.1481 = 100.0
- No.1482 = 300.0
- No.1483 = 700.0

When the feed rate change signals EXF3, EXF2, and EXF1 are turned on in this order during executing the above program, feed rate is changed as in the cycle shown in the illustration.

### Benefits

- Possibility to change feedrates without programming
- Simplification of the programming
- Improvement of the overall machining productivity

### Ordering Information

Specification	Description
A02B-0333-R716	35i-B Feed Rate Change Function
A02B-0334-R716	PM i-A Feed rate Change Function

#### Notice

Certain functions may require additional hardware, different CPU type or additional memory capacity or may cause compatibility issue with other functions. In case of doubt, contact your FANUC sales representative for additional information and support.

The information given in the FANUC manuals or original manufacturer documentation shall prevail. Technical data is subject to change without prior notice. No part of this document may be reproduced in any form. All rights reserved. © FANUC 2017

# 239

## Feed Functions

# Time Constant of Acc./Dec. After Interpolation Switching Function by Signal

## Features

This function enables to switch the time constant of acceleration/deceleration after interpolation for rapid traverse and cutting feed by input signals of the PMC. It is possible to switch between three different time constants for rapid traverse and three different time constants for cutting feed.

## Benefits

- Use the proper time constant for acceleration/deceleration after interpolation according to the current processing conditions

## Ordering Information

Specification	Description
A02B-0323-S992	30i-B Time Constant of Acc./Dec. after Interpolation Switching Function by Signal
A02B-0326-S992	31i-B5 Time Constant of Acc./Dec. after Interpolation Switching Function by Signal
A02B-0327-S992	31i-B Time Constant of Acc./Dec. after Interpolation Switching Function by Signal
A02B-0328-S992	32i-B Time Constant of Acc./Dec. after Interpolation Switching Function by Signal
A02B-0339-S992	0i-TF Time Constant of Acc./Dec. after Interpolation Switching Function by Signal
A02B-0340-S992	0i-MF Time Constant of Acc./Dec. after Interpolation Switching Function by Signal

### Notice

Certain functions may require additional hardware, different CPU type or additional memory capacity or may cause compatibility issue with other functions. In case of doubt, contact your FANUC sales representative for additional information and support.

The information given in the FANUC manuals or original manufacturer documentation shall prevail. Technical data is subject to change without prior notice. No part of this document may be reproduced in any form. All rights reserved. © FANUC 2017



# 240

## Feed Functions

# High-Speed Feedrate Override

---

## Features

This function allows to apply a feedrate override with an accelerated response. The CNC reads the high-speed feedrate override signals directly from the machine side without using the PMC. This function is useful for applications that demand a quick response, e.g. press machines.

## Benefits

- Improves the response time to feedrate change commands

## Ordering Information

Specification	Description
A02B-0333-R536	35i-B High-Speed Feedrate Override
A02B-0334-R536	PM i-A High-Speed Feedrate Override

### Notice

Certain functions may require additional hardware, different CPU type or additional memory capacity or may cause compatibility issue with other functions. In case of doubt, contact your FANUC sales representative for additional information and support.

The information given in the FANUC manuals or original manufacturer documentation shall prevail. Technical data is subject to change without prior notice. No part of this document may be reproduced in any form. All rights reserved. © FANUC 2017

# 241

## Feed Functions

# Maximum Look-Ahead Blocks 400

---

## Features

This option expands the number of look-ahead blocks for AI contour control II from 200 blocks to 400 blocks. This option is only applicable to FANUC 0i-MF series.

## Benefits

- Enables high-precision machining on cutting complex part-forms that are defined by many, tiny, program blocks such as are found in die/mold machining.
- The more look-ahead blocks the control can preview, the greater the chance it has of predicting a cutter direction change.
- In a 2-path system, the number of look-ahead blocks is 400 blocks in path 1 and 5 blocks in path 2

## Ordering Information

Specification	Description
A02B-0340-R386	0i-MF Look-Ahead Blocks 400

### Notice

Certain functions may require additional hardware, different CPU type or additional memory capacity or may cause compatibility issue with other functions. In case of doubt, contact your FANUC sales representative for additional information and support.

The information given in the FANUC manuals or original manufacturer documentation shall prevail. Technical data is subject to change without prior notice. No part of this document may be reproduced in any form. All rights reserved. © FANUC 2017

# 242

## Feed Functions

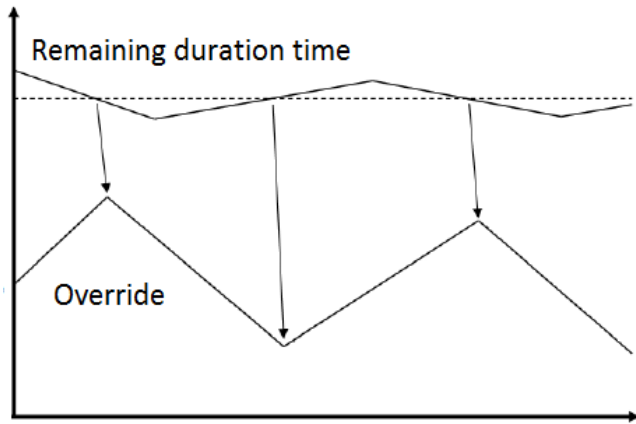

## Smart Adaptive Control

### Features

The Function Smart Adaptive Control optimizes the feed rate during machining depending on the load and the temperature of the spindle. The spindle motor power can be exploited optimally that way, especially at roughing operations. The feed rate is optimized by three different types of control:

Constant spindle load control:

The feed rate increases if the spindle load (as detected by the spindle load meter) is below a specified threshold and vice versa. This reduces cycle time on the one hand and prevents tool damage on the other hand.

Overheat avoidance control (type A):

The feed rate decreases if the spindle temperature is going to exceed its maximum temperature. Overheat alarms are avoided, leading to less down time.

Overheat avoidance control (type B) (Constant duration time control):

The feed rate decreases if the remaining duration time of the spindle is shorter than a specified threshold and vice versa. The available spindle motor power is utilized effectively while keeping a small performance buffer at the same time.

### Benefits

- Reduce cycle time
- Prevent damage to machine and tools
- Minimize downtime

### Ordering Information

Specification	Description
A02B-0323-R361	30i-B Smart Adaptive Control
A02B-0326-R361	31i-B5 Smart Adaptive Control
A02B-0327-R361	31i-B Smart Adaptive Control
A02B-0328-R361	32i-B Smart Adaptive Control
A02B-0340-R361	0i-MF Smart Adaptive Control

#### Notice

Certain functions may require additional hardware, different CPU type or additional memory capacity or may cause compatibility issue with other functions. In case of doubt, contact your FANUC sales representative for additional information and support.

The information given in the FANUC manuals or original manufacturer documentation shall prevail. Technical data is subject to change without prior notice. No part of this document may be reproduced in any form. All rights reserved. © FANUC 2017

# 243

## Functions

## Program Input

---

This section of the catalogue contains the functions related to the programming and operation of the CNC.

Some of the functions detailed in the catalogue:

- Skip functions
- Coordinate systems
- Custom Macro
- Special cycles
- Tilted Working Plane
- Macro Executor and C-Executor
- FANUC PICTURE
- FANUC Auto HMI
- Etc.

### Notice

Certain functions may require additional hardware, different CPU type or additional memory capacity or may cause compatibility issue with other functions. In case of doubt, contact your FANUC sales representative for additional information and support.

The information given in the FANUC manuals or original manufacturer documentation shall prevail. Technical data is subject to change without prior notice. No part of this document may be reproduced in any form. All rights reserved. © FANUC 2017

# 244

## Program Input

# Optional Block Skip

## Features

The Optional Block Skip function allows the operator to select whether a block in the part program that starts with a '/n', where n=1, is executed or skipped. Setting a bit in the PMC is required to activate this function. The 1st level, n=1, of Optional Block Skip is standard in the 30i/31i/32i and 0i-C controls.

## Example 1:

```
)/1 N12345 G00 X100.Z200.;
```

There is also a feature called Additional Optional Block Skip. This adds the levels 2 through 9 to the valid numbers for n, where n is level of the Optional Block Skip, '/n' at the beginning of the block. It requires setting PMC bits to activate these levels of Optional Block Skip.

## Example 2:

```
)/3 N12345 G00 X100.Z200.;
```

where n=3 for the 3rd level of Optional Block Skip

This function is a basic function in FANUC Series 0i-F.

## Benefits

- Additional levels of Block Skip can be added to the CNC
- Higher flexibility of the programming
- Improvement of the overall machining productivity

## Ordering Information

Specification	Description
A02B-0323-J955	30i-B Optional Block Skip (Total 9)
A02B-0326-J955	31i-B5 Optional Block Skip (Total 9)
A02B-0327-J955	31i-B Optional Block Skip (Total 9)
A02B-0328-J955	32i-B Optional Block Skip (Total 9)

### Notice

Certain functions may require additional hardware, different CPU type or additional memory capacity or may cause compatibility issue with other functions. In case of doubt, contact your FANUC sales representative for additional information and support.

The information given in the FANUC manuals or original manufacturer documentation shall prevail. Technical data is subject to change without prior notice. No part of this document may be reproduced in any form. All rights reserved. © FANUC 2017

# 245

## Program Input

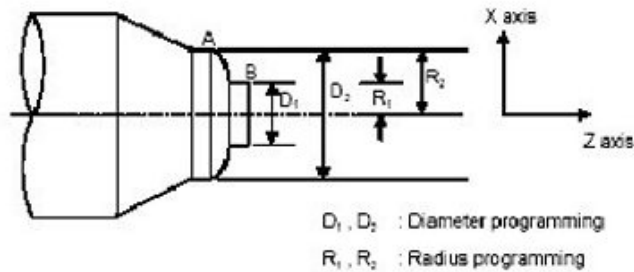

# Dynamic Switching of Diameter/Radius Specification

## Features

The Dynamic Switching of Diameter/Radius Specification function enables the user to switch between diameter and radius programming by using a PMC signal or G code.

When turning is performed, the cross section of a workpiece is usually a circle. The size of the circle may be specified by its diameter or radius. When the diameter is specified, it is called diameter programming and when the radius is specified, it is called radius programming. Whether to use radius programming or diameter programming is chosen for each axis by setting a parameter.

There may be cases where some coordinates or program items for an axis in diameter programming mode should preferably be handled in radius programming mode. This function enables the user to switch between diameter programming and radius programming by using a signal or G code command. The user can thus handle coordinates, program items, and other settings for an axis in diameter programming mode as well as in radius programming mode.

This function is a basic function in FANUC Series 0i-MF and 0i-TF.

## Benefits

- Addition of flexibility to the programming
- Improvement of the overall machining productivity

## Ordering Information

Specification	Description
A02B-0323-S630	30i-B Diameter / Radius Dynamic Switching
A02B-0326-S630	31i-B5 Diameter / Radius Dynamic Switching
A02B-0327-S630	31i-B Diameter / Radius Dynamic Switching
A02B-0328-S630	32i-B Dynamic Switching of Diameter/Radius Specification

### Notice

Certain functions may require additional hardware, different CPU type or additional memory capacity or may cause compatibility issue with other functions. In case of doubt, contact your FANUC sales representative for additional information and support.

The information given in the FANUC manuals or original manufacturer documentation shall prevail. Technical data is subject to change without prior notice. No part of this document may be reproduced in any form. All rights reserved. © FANUC 2017

# 246

## Program Input

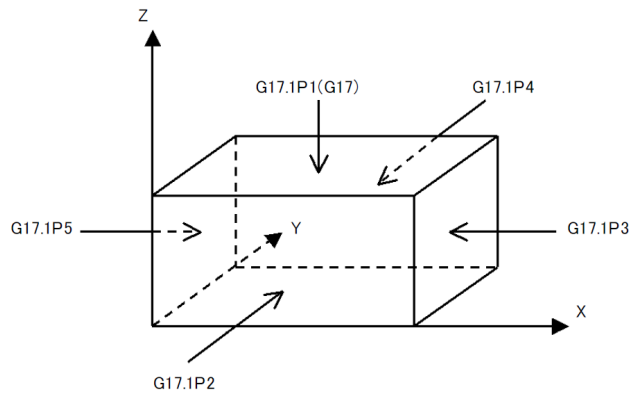

# Plane Conversion Function

## Features

This function converts a machining program created on the G17 plane in the right-hand cartesian coordinate system into a program for another plane specified by G17.1Px commands.

## Benefits

- Simplifies programming

## Ordering Information

Specification	Description
A02B-0323-R701	30i-B Plane Conversion Function
A02B-0326-R701	31i-B5 Plane Conversion Function
A02B-0327-R701	31i-B Plane Conversion Function

### Notice

Certain functions may require additional hardware, different CPU type or additional memory capacity or may cause compatibility issue with other functions. In case of doubt, contact your FANUC sales representative for additional information and support.

The information given in the FANUC manuals or original manufacturer documentation shall prevail. Technical data is subject to change without prior notice. No part of this document may be reproduced in any form. All rights reserved. © FANUC 2017

# 247

## Program Input

# Polar Coordinate Command

## Features

When machining using arc based coordinates, it is usually easier to specify a move in terms of an angular displacement and a radius.

By turning on the Polar Coordinate Command function, the programmer can choose to command moves that employ polar coordinates in any segment of his program. He can also cancel polar coordinate commands and revert to the traditional Cartesian command system when those are more appropriate.

This function is a basic function in FANUC Series 0i-MF.

## Benefits

- Ease of programming coordinates on arcs and circles.
- Transposition of angles and radii dimensions direct from blueprints.

## Ordering Information

Specification	Description
A02B-0323-J818	30i-B Polar Coordinate Command
A02B-0326-J818	31i-B5 Polar Coordinate Command
A02B-0327-J818	31i-B Polar Coordinate Command
A02B-0328-J818	32i-B Polar Coordinate Command

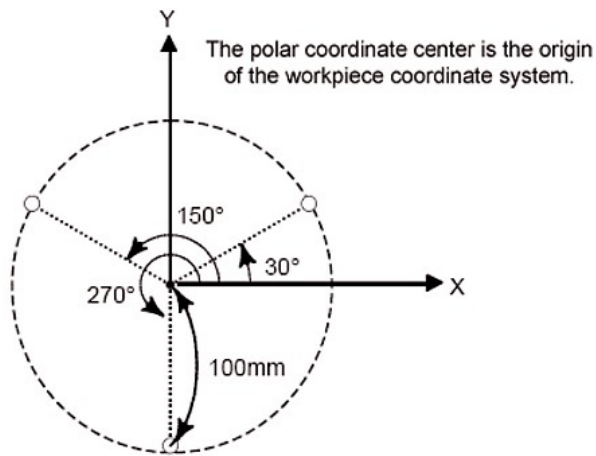

### Notice

Certain functions may require additional hardware, different CPU type or additional memory capacity or may cause compatibility issue with other functions. In case of doubt, contact your FANUC sales representative for additional information and support.

The information given in the FANUC manuals or original manufacturer documentation shall prevail. Technical data is subject to change without prior notice. No part of this document may be reproduced in any form. All rights reserved. © FANUC 2017



# 248

## Program Input

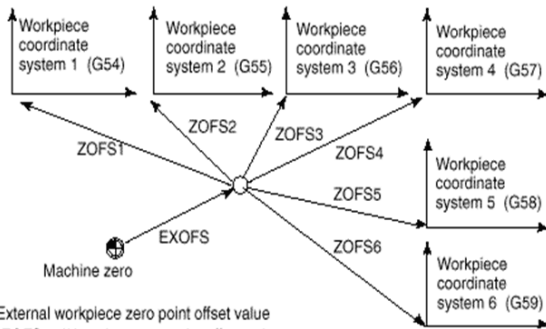

EXOFS : External workpiece zero point offset value  
ZOFs1 to ZOFs6 : Workpiece zero point offset value

# Workpiece Coordinate System

## Features

Coordinate system used for machining a workpiece is referred to as a workpiece coordinate system.

This function is a basic function in FANUC Series 0i-F.

## Benefits

- Six standard work coordinate systems (G54-G59)
- Part program reflects part print dimensions
- Fixture location inaccuracies compensated
- Additional adjustment using common offset

## Ordering Information

Specification	Description
A02B-0323-J894	30i-B Workpiece Coordinate System
A02B-0326-J894	31i-B5 Workpiece Coordinate System
A02B-0327-J894	31i-B Workpiece Coordinate System
A02B-0328-J894	32i-B Workpiece Coordinate System
A02B-0333-J894	35i-B Workpiece Coordinate System

### Notice

Certain functions may require additional hardware, different CPU type or additional memory capacity or may cause compatibility issue with other functions. In case of doubt, contact your FANUC sales representative for additional information and support.

The information given in the FANUC manuals or original manufacturer documentation shall prevail. Technical data is subject to change without prior notice. No part of this document may be reproduced in any form. All rights reserved. © FANUC 2017

# 249

## Program Input

# Workpiece Coordinate System Preset

## Features

The workpiece coordinate system, with its zero point shifted away from the machine coordinate system zero point by the workpiece origin offset value, is set by returning the tool to the reference position by a manual operation.

In addition, when an absolute position detector is provided, the workpiece coordinate system is automatically set by reading the machine coordinate value from the detector when the control is powered on without performing a manual reference position return operation.

The set workpiece coordinate system may shift by any of the following commands or operations:

- Manual intervention performed when the manual absolute signal is off
- Move command executed in the machine lock state
- Movement by handle interruption
- Operation using the mirror image function
- Shifting the workpiece coordinate system by setting the local coordinate system or workpiece coordinate system

By G code specification or MDI operation, a workpiece coordinate system shifted by an operation above can be preset to a workpiece coordinate system offset from the machine zero point by a workpiece origin offset as in the case of manual reference position return.

This function is a basic function in FANUC Series 0i-F.

## Benefits

- Simplification of the programming
- Improvement of the overall machining productivity

## Ordering Information

Specification	Description
A02B-0323-J917	30i-B Workpiece Coordinate Preset
A02B-0326-J917	31i-B5 Workpiece Coordinate Preset
A02B-0327-J917	31i-B Workpiece Coordinate Preset
A02B-0328-J917	32i-B Workpiece Coordinate Preset

### Notice

Certain functions may require additional hardware, different CPU type or additional memory capacity or may cause compatibility issue with other functions. In case of doubt, contact your FANUC sales representative for additional information and support.

The information given in the FANUC manuals or original manufacturer documentation shall prevail. Technical data is subject to change without prior notice. No part of this document may be reproduced in any form. All rights reserved. © FANUC 2017

# 250

## Program Input

# Addition of Workpiece Coordinate System 48 Pairs

## Features

Besides the six workpiece coordinate systems based on G54 to G59 (standard workpiece coordinate systems), up to 48 additional workpiece coordinate systems can be used optionally. As with the workpiece coordinate system based on G54 to G59, the following workpiece origin offset setting and modification methods are available:

- MDI-based method
- Program-based method
- Setting based on programmable data input (G10L2Pp)
- Setting based on custom macros

This function is a basic function in FANUC Series 0i-MF.

## Benefits

- Increase of the flexibility of the machining
- Simplification of the programming
- Improvement of the overall machining productivity

## Ordering Information

Specification	Description
A02B-0323-J895	30i-B Workpiece Coordinate, 48 Pairs
A02B-0326-J895	31i-B5 Workpiece Coordinate, 48 Pairs
A02B-0327-J895	31i-B Workpiece Coordinate, 48 Pairs
A02B-0328-J895	32i-B Workpiece Coordinate, 48 Pairs
A02B-0333-J895	35i-B Workpiece Coordinate, 48 Pairs

### Notice

Certain functions may require additional hardware, different CPU type or additional memory capacity or may cause compatibility issue with other functions. In case of doubt, contact your FANUC sales representative for additional information and support.

The information given in the FANUC manuals or original manufacturer documentation shall prevail. Technical data is subject to change without prior notice. No part of this document may be reproduced in any form. All rights reserved. © FANUC 2017

# 251

## Program Input

# Addition of Workpiece Coordinate System 300 Pairs

Besides the six workpiece coordinate systems based on G54 to G59 (standard workpiece coordinate systems), up to 300 additional workpiece coordinate systems can be used optionally. As with the workpiece coordinate system based on G54 to G59, the following workpiece origin offset setting and modification methods are available:

- MDI-based method
- Program-based method
- Setting based on programmable data input (G10L2Pp)
- Setting based on custom macros

## Benefits

- Increase of the flexibility of the machine
- Simplification of the programming
- Improvement of the overall machining productivity

## Ordering Information

Specification	Description
A02B-0323-J919	30i-B Addition of Workpiece Coordinate System, 300 Pairs
A02B-0326-J919	31i-B5 Addition of Workpiece Coordinate System, 300 Pairs
A02B-0327-J919	31i-B Addition of Workpiece Coordinate System, 300 Pairs
A02B-0340-J919	0i-MF Addition of Workpiece Coordinate System 300 Pairs

### Notice

Certain functions may require additional hardware, different CPU type or additional memory capacity or may cause compatibility issue with other functions. In case of doubt, contact your FANUC sales representative for additional information and support.

The information given in the FANUC manuals or original manufacturer documentation shall prevail. Technical data is subject to change without prior notice. No part of this document may be reproduced in any form. All rights reserved. © FANUC 2017

# 252

## Program Input

# Positioning in Machine Coordinate System with Feedrate

---

## Features

Conventionally machine coordinate system setting (G53) is performed only at a rapid traverse rate.

With this function, the machine coordinate system setting is available at a feed rate.

## Example:

```
G53.2 G01 IP_ F_;
```

IP\_: Dimension word

F\_: Feed rate

## Benefits

- Increase of the setting of coordinate system
- Simplification of the programming
- Improvement of the overall machining productivity

## Ordering Information

Specification	Description
A02B-0323-R553	30i-B Positioning in Machine Coordinate System with Feed Rate
A02B-0326-R553	31i-B5 Positioning in Machine Coordinate System with Feed Rate
A02B-0327-R553	31i-B Positioning in Machine Coordinate System with Feed Rate
A02B-0328-R553	32i-B Positioning in Machine Coordinate System with Feed Rate
A02B-0339-R553	0i-TF Positioning in Machine Coordinate System with Feedrate
A02B-0340-R553	0i-MF Positioning in Machine Coordinate System with Feedrate

### Notice

Certain functions may require additional hardware, different CPU type or additional memory capacity or may cause compatibility issue with other functions. In case of doubt, contact your FANUC sales representative for additional information and support.

The information given in the FANUC manuals or original manufacturer documentation shall prevail. Technical data is subject to change without prior notice. No part of this document may be reproduced in any form. All rights reserved. © FANUC 2017

# 253

## Program Input

# Direct Drawing Dimension Programming

## Features

The Direct Drawing Dimension Programming is a function that simplifies part programming on the shop floor.

Angles of straight lines, chamfering values, corner rounding values, and other dimensional values on machining drawings can be programmed by directly inputting these values.

In addition, chamfering and corner rounding can be inserted between straight lines having an arbitrary angle.

This function is a basic function in FANUC Series 0i-TF.

## Benefits

- Addition of programming functions to the CNC
- Simplification of the programming
- Improvement of the overall machining productivity

## Ordering Information

Specification	Description
A02B-0323-J870	30i-B Direct Drawing Programming
A02B-0326-J870	31i-B5 Direct Drawing Programming
A02B-0327-J870	31i-B Direct Drawing Programming
A02B-0328-J870	32i-B Direct Drawing Programming

### Notice

Certain functions may require additional hardware, different CPU type or additional memory capacity or may cause compatibility issue with other functions. In case of doubt, contact your FANUC sales representative for additional information and support.

The information given in the FANUC manuals or original manufacturer documentation shall prevail. Technical data is subject to change without prior notice. No part of this document may be reproduced in any form. All rights reserved. © FANUC 2017

# 254

## Program Input

# G-Code System B/C

## Features

With the CNC for the lathe system, the G codes listed below are available. Three types of G code systems are usable: A, B, and C. A G code system can be selected by parameter setting.

G-Code System			Group	Function
A	B	C		
G00	G00	G00	01	Positioning (Rapid traverse)
G01	G01	G01		Linear interpolation (Cutting feed)
G02	G02	G02		Circular interpolation CW or Helical interpolation CW
G03	G03	G03		Circular interpolation CCW or Helical interpolation CCW
G02.2	G02.2	G02.2		Involute interpolation CW
G02.3	G02.3	G02.3		Exponential interpolation CW
G02.4	G02.4	G02.4		Three- dimensional coordinate conversion CW
G03.2	G03.2	G03.2		Involute Interpolation CCW
G03.3	G03.3	G03.3		Exponential interpolation CCW
G03.4	G03.4	G03.4		Three- dimensional coordinate conversion CCW
G04	G04	G04	00	Dwell
G05	G05	G05		AI contour control (command compatible with high precision contour control)
G05.1	G05.1	G05.1		AI contour control/ Nano smoothing/ Smooth interpolation
G05.4	G05.4	G05.4	HRV3,4 on/off	
G06.2	G06.2	G06.2	01	NURBS interpolation
G07	G07	G07	00	Hypothetical axis interpolation
G07.1	G07.1	G07.1		Cylindrical interpolation
G08	G08	G08		Advanced preview control
G09	G09	G09		Exact stop
G10	G10	G10		Programmable data input
G10.6	G10.6	G10.6		Tool retract and recover
G10.9	G10.9	G10.9		Programmable switching of diameter/ radius specification
G11	G11	G11	Programmable data input mode cancel	
G12.1	G12.1	G12.1	21	Polar coordinate interpolation mode
G13.1	G13.1	G13.1		Polar coordinate interpolation cancel mode
G15	G15	G15	24	Polar coordinate command cancel
G16	G16	G16		Polar coordinate command
G17	G17	G17	16	XpYp plane selection
G18	G18	G18		ZpXp plane selection
G19	G19	G19		YpZp plane selection
G20	G20	G20	06	Input in inch

### Notice

Certain functions may require additional hardware, different CPU type or additional memory capacity or may cause compatibility issue with other functions. In case of doubt, contact your FANUC sales representative for additional information and support.

The information given in the FANUC manuals or original manufacturer documentation shall prevail. Technical data is subject to change without prior notice. No part of this document may be reproduced in any form. All rights reserved. © FANUC 2017

# 255

G-Code System			Group	Function
A	B	C		
G21	G21	G21		Input in inch

This function is a basic function in FANUC Series 0i-TF.

## Benefits

- Increase of the programming flexibility of the CNC
- Improvement of the overall machining productivity

## Ordering Information

Specification	Description
A02B-0323-J871	30i-B G Code System B and C
A02B-0326-J871	31i-B5 G Code System B and C
A02B-0327-J871	31i-B G Code System B and C
A02B-0328-J871	32i-B G Code System B and C

### Notice

Certain functions may require additional hardware, different CPU type or additional memory capacity or may cause compatibility issue with other functions. In case of doubt, contact your FANUC sales representative for additional information and support.

The information given in the FANUC manuals or original manufacturer documentation shall prevail. Technical data is subject to change without prior notice. No part of this document may be reproduced in any form. All rights reserved. © FANUC 2017



# 256

## Program Input

# Lathe / Machining Center G-Code System Switching Function

---

## Features

This function switches over G code system of each path for lathe and machining center by certain programming commands (M codes).The optimum program command and function for each processing, the turning processing and the milling processing, is available by switching mode.

Note: tool offset for Milling and Turning function (R595) and Designation of Designation of Machine Control, Type Multiple System (S838/C) is required.

## Benefits

- Increase of the programming flexibility
- Improvement of the overall machining productivity

## Ordering Information

Specification	Description
A02B-0323-R597	30i-B Lathe/Machining Center G-Code System Switching Function
A02B-0326-R597	31i-B5 Lathe/Machining Center G-Code System Switching Function
A02B-0327-R597	31i-B Lathe/Machining Center G-Code System Switching Function
A02B-0328-R597	32i-B Lathe/Machining Center G-Code System Switching Function

### Notice

Certain functions may require additional hardware, different CPU type or additional memory capacity or may cause compatibility issue with other functions. In case of doubt, contact your FANUC sales representative for additional information and support.

The information given in the FANUC manuals or original manufacturer documentation shall prevail. Technical data is subject to change without prior notice. No part of this document may be reproduced in any form. All rights reserved. © FANUC 2017

# 257

## Program Input

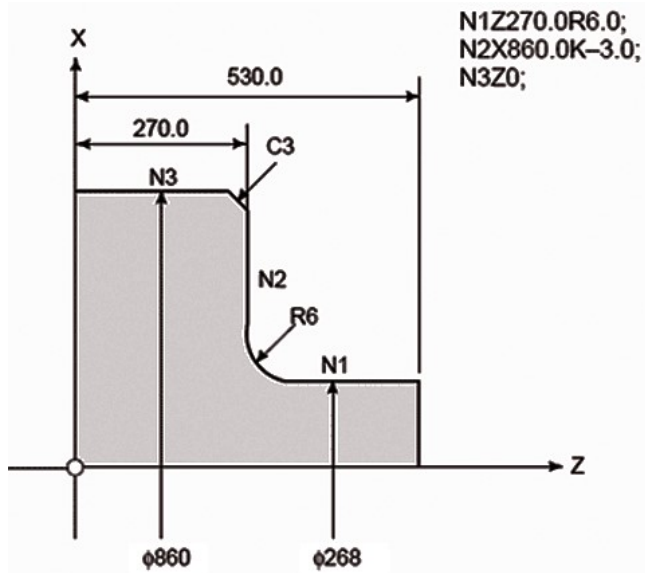

# Chamfering / Corner Rounding

## Features

The Chamfering / Corner Radius function is used on turning ('T' type) controls to insert a defined 45-degree chamfer or radius between two single-axis linear move program blocks that intersect at right angles.

It allows the programmer to enter the hypothetical corner intersection coordinates without having to calculate the start and end points of the chamfer or radius.

This function is a basic function in FANUC Series 0i-TF.

## Benefits

- Simplifies programming of chamfers and radii between right angle linear moves
- Simplifies blueprint programming
- Easy shop-floor changes to add radii and chamfers to existing programs

## Ordering Information

Specification	Description
A02B-0323-J875	30i-B Chamfering/Corner R (Turning)
A02B-0326-J875	31i-B5 Chamfering/Corner R (Turning)
A02B-0327-J875	31i-B Chamfering/Corner R (Turning)
A02B-0328-J875	32i-B Chamfering/Corner R (Turning)

### Notice

Certain functions may require additional hardware, different CPU type or additional memory capacity or may cause compatibility issue with other functions. In case of doubt, contact your FANUC sales representative for additional information and support.

The information given in the FANUC manuals or original manufacturer documentation shall prevail. Technical data is subject to change without prior notice. No part of this document may be reproduced in any form. All rights reserved. © FANUC 2017

# 258

## Program Input

# Optional Chamfering / Corner Rounding

## Features

The Optional Chamfering / Corner Radius function is used on milling ('M' type) controls to insert a defined chamfer or radius between any two linear or circular program moves.

It allows programming of geometry end-coordinates is if chamfer or corner rounding were not required. Then, chamfers or radii can easily be applied by appending to the first of the program blocks either a (comma),C\_ %value% or (comma),R\_ %value%.

This function is a basic function in FANUC Series 0i-MF.

## Benefits

- Simplifies programming of chamfers and radii
- Simplifies blueprint programming
- Easy shop floor changes to add or change radii and chamfers on existing programs without changing the program block end-coordinates.

## Ordering Information

Specification	Description
A02B-0323-S615	30i-B Optional Chamfering Corner R (Milling)
A02B-0326-S615	31i-B5 Optional Chamfering Corner R (Milling)
A02B-0327-S615	31i-B Optional Chamfering Corner R (Milling)
A02B-0328-S615	32i-B Optional Chamfering Corner R (Milling)

### Notice

Certain functions may require additional hardware, different CPU type or additional memory capacity or may cause compatibility issue with other functions. In case of doubt, contact your FANUC sales representative for additional information and support.

The information given in the FANUC manuals or original manufacturer documentation shall prevail. Technical data is subject to change without prior notice. No part of this document may be reproduced in any form. All rights reserved. © FANUC 2017

# 259

## Program Input

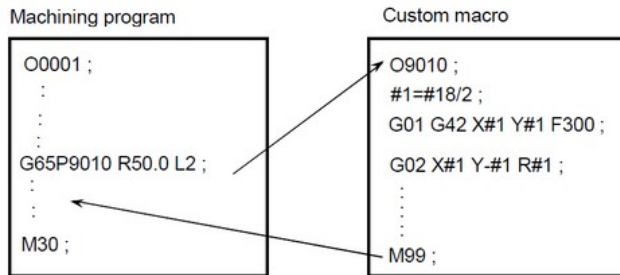

## Custom Macro

### Features

The Custom Macro function (similar to Basic programming) allows programming of G code with variables, logical expressions, conditional loops. It also allows to read/write machine status to/from the NC program. Custom Macro is required for probing applications.

Although subprograms are useful for repeating the same operation, the custom macro function also allows use of variables, arithmetic and logic operations, and conditional branches for easy development of general programs such as pocketing and user-defined canned cycles. A machining program can call a custom macro with a simple command, just like a subprogram.

An ordinary machining program specifies a G code and the travel distance directly with a numeric value. With a custom macro, numeric values can be specified directly or using a variable number. When a variable number is used, the variable value can be changed by a program or using operations on the MDI panel.

This function is a basic function in FANUC Series 0i-F.

### Benefits

- Recipe management
- Custom Canned cycles
- CNC and operator messages
- Automation of the communication to the Ladder Logic program
- Automation of Probing system
- Update of offsets
- Reduction of Part Program size

### Ordering Information

Specification	Description
A02B-0323-J873	30i-B Custom Macro
A02B-0323-R583	30i-B Custom Macro Variable Names with 31 Characters
A02B-0326-J873	31i-B5 Custom Macro
A02B-0326-R583	31i-B5 Custom Macro Variable Names with 31 Characters
A02B-0327-J873	31i-B Custom Macro
A02B-0327-R583	31i-B Custom Macro Variable Names with 31 Characters
A02B-0328-J873	32i-B Custom Macro
A02B-0328-R583	32i-B Custom Macro Variable Names with 31 Characters
A02B-0339-R583	0i-TF Custom Macro Variable Names with 31 Characters

#### Notice

Certain functions may require additional hardware, different CPU type or additional memory capacity or may cause compatibility issue with other functions. In case of doubt, contact your FANUC sales representative for additional information and support.

The information given in the FANUC manuals or original manufacturer documentation shall prevail. Technical data is subject to change without prior notice. No part of this document may be reproduced in any form. All rights reserved. © FANUC 2017

# 260

Specification	Description
A02B-0340-R583	0i-MF Custom Macro Variable Names with 31 Characters

**Notice**

Certain functions may require additional hardware, different CPU type or additional memory capacity or may cause compatibility issue with other functions. In case of doubt, contact your FANUC sales representative for additional information and support.

The information given in the FANUC manuals or original manufacturer documentation shall prevail. Technical data is subject to change without prior notice. No part of this document may be reproduced in any form. All rights reserved. © FANUC 2017

# 261

## Program Input

# Addition of Custom Macro Common Variables

## Features

Allows additional data fields for common variables (#100 and #500 series)

This function is a basic function in FANUC Series 0i-F.

## Benefits

- Allows permanent data retention
- No need to re-write data
- Keep calibration data with the job
- No need to use same variable numbers for interim calculations
- Facilitates debugging of Macro B program

## Ordering Information

Specification	Description
A02B-0323-J887	30i-B Addition of Custom Macro Common Variables, 500 Variables
A02B-0326-J887	31i-B5 Addition of Custom Macro Common Variables, 500 Variables
A02B-0327-J887	31i-B Addition of Custom Macro Common Variables, 500 Variables
A02B-0328-J887	32i-B Addition of Custom Macro Common Variables, 500 Variables

### Notice

Certain functions may require additional hardware, different CPU type or additional memory capacity or may cause compatibility issue with other functions. In case of doubt, contact your FANUC sales representative for additional information and support.

The information given in the FANUC manuals or original manufacturer documentation shall prevail. Technical data is subject to change without prior notice. No part of this document may be reproduced in any form. All rights reserved. © FANUC 2017

# 262

## Program Input

# Addition of Custom Macro Common Variables 1000

## Features

The Addition of Custom Macro Common Variables 1000 function provides the possibility to use the custom macro common variables #150-#199, #550-#999, and #98000-#98499 in addition to custom macro common variables #100-#149 and #500-#549.

## Benefits

- Allows permanent data retention
- No need to re-write data
- Keep calibration data with the job
- No need to use same variable numbers for interim calculations
- Facilitates debugging of Macro B program

## Ordering Information

Specification	Description
A02B-0323-R687	30i-B Addition of Custom Macro Common Variables, 1000 Variables
A02B-0326-R687	31i-B5 Addition of Custom Macro Common Variables, 1000 Variables
A02B-0327-R687	31i-B Addition of Custom Macro Common Variables, 1000 Variables
A02B-0328-R687	32i-B Addition of Custom Macro Common Variables, 1000 Variables
A02B-0333-R687	35i-B Addition of Custom Macro Common Variables, 1000 Variables
A02B-0339-R687	0i-TF Additional Custom Maco Common Variables
A02B-0340-R687	0i-MF Additional Custom Maco Common Variables

### Notice

Certain functions may require additional hardware, different CPU type or additional memory capacity or may cause compatibility issue with other functions. In case of doubt, contact your FANUC sales representative for additional information and support.

The information given in the FANUC manuals or original manufacturer documentation shall prevail. Technical data is subject to change without prior notice. No part of this document may be reproduced in any form. All rights reserved. © FANUC 2017

# 263

## Program Input

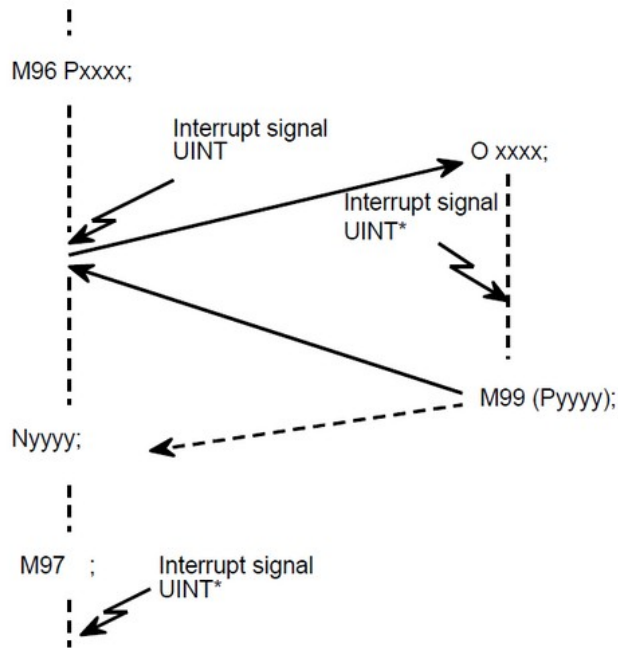

## Interrupt Type Custom Macro

### Features

When custom macro interruption signal is input during automatic operation, the block currently under execution is interrupted and the specified custom macro is activated.

After execution of this custom macro, it returns to the interrupted block and continues execution of the remaining commands.

This function is a basic function in FANUC Series 0i-F.

### Benefits

- Allows macro program to jump to specific instructions depending on conditions

### Ordering Information

Specification	Description
A02B-0323-J874	30i-B Interruption Type Custom Macro
A02B-0326-J874	31i-B5 Interruption Type Custom Macro
A02B-0327-J874	31i-B Interruption Type Custom Macro
A02B-0328-J874	32i-B Interruption Type Custom Macro
A02B-0333-J874	35i-B Interruption Type Custom Macro
A02B-0334-J874	PM i-A Interruption Type Custom Macro

### Notice

Certain functions may require additional hardware, different CPU type or additional memory capacity or may cause compatibility issue with other functions. In case of doubt, contact your FANUC sales representative for additional information and support.

The information given in the FANUC manuals or original manufacturer documentation shall prevail. Technical data is subject to change without prior notice. No part of this document may be reproduced in any form. All rights reserved. © FANUC 2017



# 264

## Program Input

# Multi-Repetitive Cycles

## Features

Multiple Repetitive Cycles are a series of seven additional Canned Cycles for Turning applications.

G70, G71, G72, G73, G74, G75 and G76 ease the programming of complex machining cycles.

- G71 - Stock Removal in Turning. Type I figures only, no pockets.
- G72 - Stock Removal in Facing. Type I figures only, no pockets.
- G73 - Pattern Repeating.
- G70 - Finishing
- G74 - End Face Peck Drilling Cycle.
- G75 - Outer Diameter / Internal Diameter Drilling Cycle.
- G76 - Multiple Threading Cycle.

This function is a basic function in FANUC Series 0i-TF.

## Benefits

- Simplification of the CNC Programming
- Increase of the productivity of the machine

## Ordering Information

Specification	Description
A02B-0323-J877	30i-B Multi-Repetitive Cycles
A02B-0326-J877	31i-B5 Multi-Repetitive Cycles
A02B-0327-J877	31i-B Multi-Repetitive Cycles
A02B-0328-J877	32i-B Multi-Repetitive Cycles

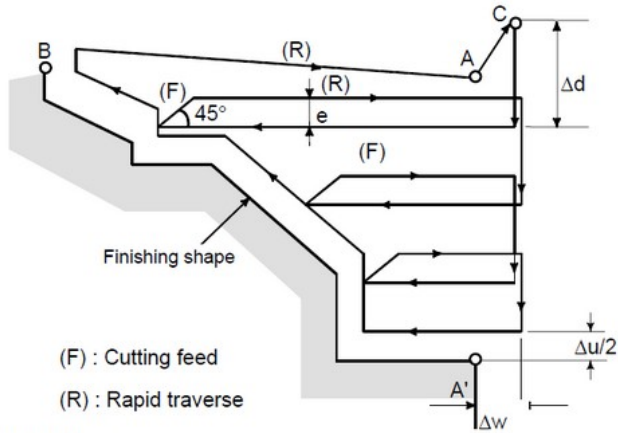

```
G71 U(Δd) R(e);
G71 P(ns) Q(nf) U(Δu) W(Δw) F(f) S(s) T(t);
N(ns) . . .
. . . . .
F_
S_
T_
N(nf) . . . ;
```

The move command of a finished shape of A to A' to B is specified in the blocks from sequence number ns to nf.

### Notice

Certain functions may require additional hardware, different CPU type or additional memory capacity or may cause compatibility issue with other functions. In case of doubt, contact your FANUC sales representative for additional information and support.

The information given in the FANUC manuals or original manufacturer documentation shall prevail. Technical data is subject to change without prior notice. No part of this document may be reproduced in any form. All rights reserved. © FANUC 2017

# 265

## Program Input

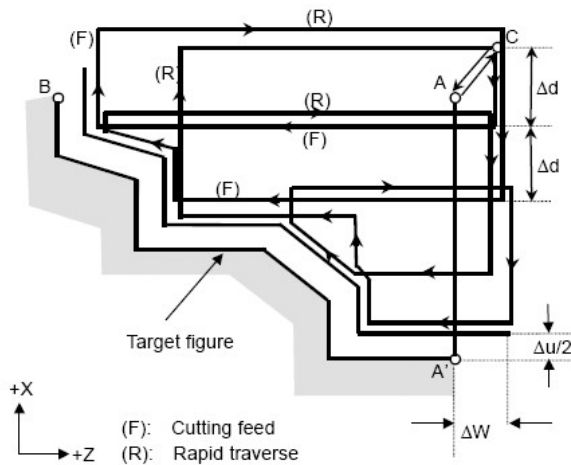

## Multi-Repetitive Cycles II

### Features

Multiple Repetitive Cycles II are an enhanced version of the Multiple Repetitive Cycles I, G71 and G72, that enable the programmer to define pockets on the work piece to be machined.

With Multiple Repetitive Cycles II, the tool cuts the work piece along the target figure (comp. picture).

This function is a basic function in FANUC Series 0i-TF.

### Benefits

- Simplification of the Programming of the cycles
- Increase of the productivity of the machine

### Ordering Information

Specification	Description
A02B-0323-J889	30i-B Multi-Repetitive Cycles II
A02B-0326-J889	31i-B5 Multi-Repetitive Cycles II
A02B-0327-J889	31i-B Multi-Repetitive Cycles II
A02B-0328-J889	32i-B Multi-Repetitive Cycles II

### Notice

Certain functions may require additional hardware, different CPU type or additional memory capacity or may cause compatibility issue with other functions. In case of doubt, contact your FANUC sales representative for additional information and support.

The information given in the FANUC manuals or original manufacturer documentation shall prevail. Technical data is subject to change without prior notice. No part of this document may be reproduced in any form. All rights reserved. © FANUC 2017

# 266

## Program Input

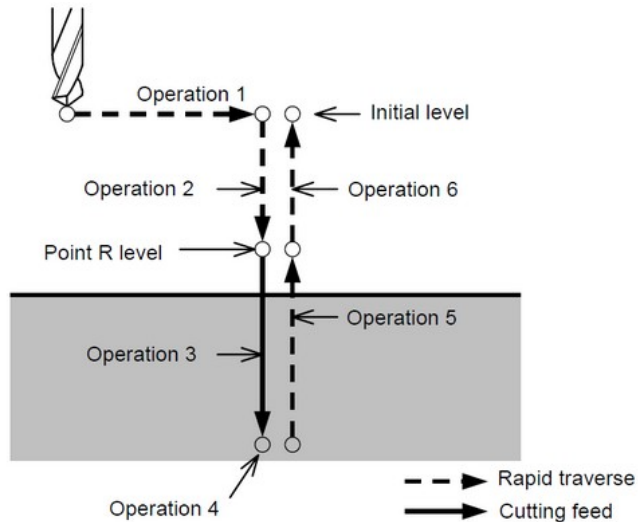

## Canned Cycles for Drilling

### Features

Canned Cycles for Drilling are programming commands that perform complex drilling operations in a single command block.

This function is a basic function in FANUC Series 0i-MF and 0i-TF.

### Benefits

- Simplification of the programming of complex cycles
- Increase of the productivity of the machine

### Ordering Information

Specification	Description
A02B-0323-J890	30i-B Canned Cycles for Drilling
A02B-0326-J890	31i-B5 Canned Cycles for Drilling
A02B-0327-J890	31i-B Canned Cycles for Drilling
A02B-0328-J890	32i-B Canned Cycles for Drilling

### Notice

Certain functions may require additional hardware, different CPU type or additional memory capacity or may cause compatibility issue with other functions. In case of doubt, contact your FANUC sales representative for additional information and support.

The information given in the FANUC manuals or original manufacturer documentation shall prevail. Technical data is subject to change without prior notice. No part of this document may be reproduced in any form. All rights reserved. © FANUC 2017

# 267

## Program Input

# In-Position Check Switching Function for Drilling Canned Cycle

## Features

Provides four dedicated in-position zone settings that are defined for use during drilling canned cycles. Three settings may be set to utilize larger in-position zones for moves within drilling canned cycles that do not require fine positioning. Cycle time is reduced by not spending excess time applying higher accuracy positioning when it is not required.

In-position zone setting for final depth of the drilling canned cycle is set separately, facilitating high accuracy positioning to meet part specifications.

## Benefits

- Reduces execution time of Drilling Canned Cycles
- Allows tighter In-Position zone to be used for final depth, without adverse affect on other drilling/positioning moves during the canned cycle
- Tool life during drilling cycles may be improved by more efficient operation

## Ordering Information

Specification	Description
A02B-0323-R648	30i-B In-Position Check Switching Function for Canned Cycles for Drilling
A02B-0326-R648	31i-B5 In-Position Check Switching Function for Canned Cycles for Drilling
A02B-0327-R648	31i-B In-Position Check Switching Function for Canned Cycles for Drilling
A02B-0328-R648	32i-B In-Position Check Switching Function for Canned Cycles for Drilling
A02B-0333-R648	35i-B In-Position Check Switching Function for Canned Cycles for Drilling

High-Speed peck Drilling Cycle (G73)

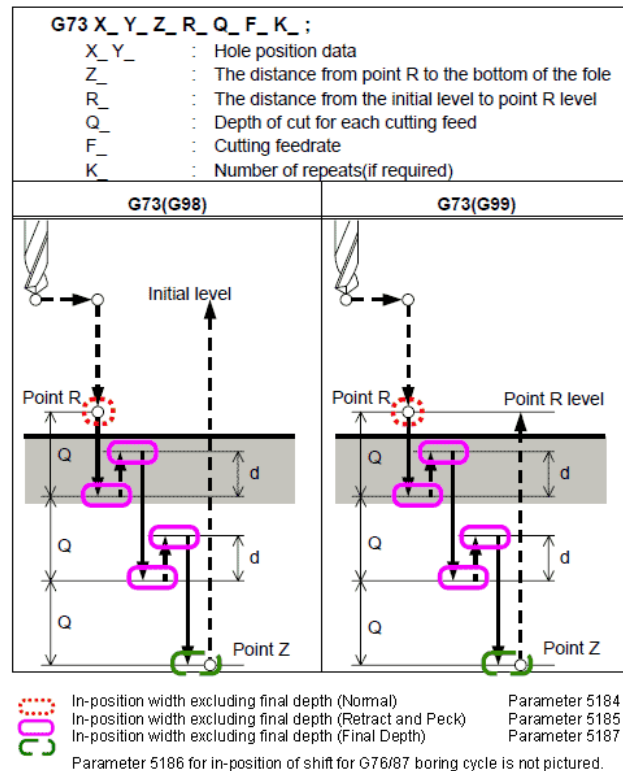

### Notice

Certain functions may require additional hardware, different CPU type or additional memory capacity or may cause compatibility issue with other functions. In case of doubt, contact your FANUC sales representative for additional information and support.

The information given in the FANUC manuals or original manufacturer documentation shall prevail. Technical data is subject to change without prior notice. No part of this document may be reproduced in any form. All rights reserved. © FANUC 2017

# 268

## Program Input

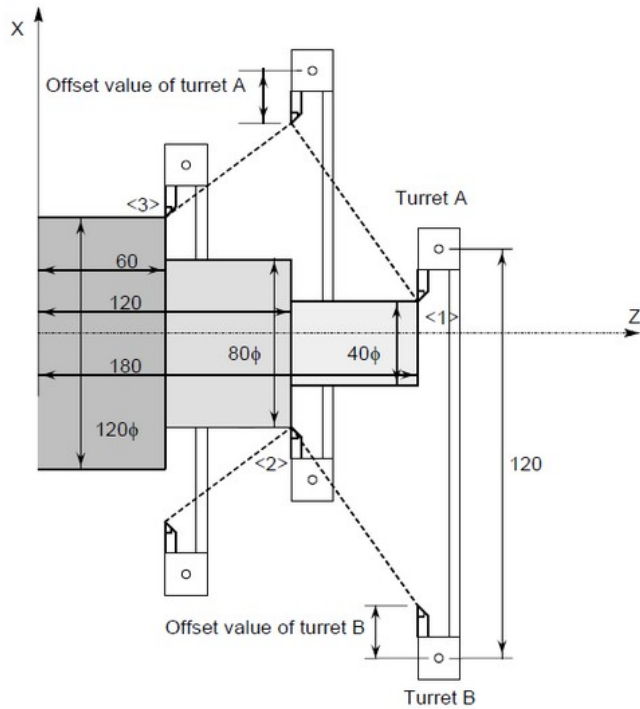

# Mirror Image for Double Turret

## Features

By applying mirror image to the X-axis with a G code, a machining program for the opposite tool post can be created for symmetric cutting as if the program were created in the coordinate system on the same side.

When G68 is designated, the coordinate system is shifted to the double turret side, and the X-axis sign is reversed from the programmed command to perform symmetrical cutting. To use this function, set the distance between the two tool posts to a parameter.

## Programming example

X.40.0 Z180.0 T0101	Position tool post A at '1'
G68	Shift the coordinate system by the distance A to B (120mm), and turn mirror image on
X80.0 Z120.0 T0202	Position tool post B at '2'
G69	Shift the coordinate system by the distance B to A, and cancel mirror image.
X120.0 Z60.0 T0101	Position tool post A at '3'

This function is a basic function in FANUC Series 0i-TF.

## Benefits

- Simplification of the programming
- Improvement of the overall machining productivity

## Ordering Information

Specification	Description
A02B-0323-J881	30i-B Mirror Image for Double Turret
A02B-0326-J881	31i-B5 Mirror Image for Double Turret
A02B-0327-J881	31i-B Mirror Image for Double Turret
A02B-0328-J881	32i-B Mirror Image for Double Turret
A02B-0339-J881	0i-TF Mirror Image for Double Turret

### Notice

Certain functions may require additional hardware, different CPU type or additional memory capacity or may cause compatibility issue with other functions. In case of doubt, contact your FANUC sales representative for additional information and support.

The information given in the FANUC manuals or original manufacturer documentation shall prevail. Technical data is subject to change without prior notice. No part of this document may be reproduced in any form. All rights reserved. © FANUC 2017

# 269

## Program Input

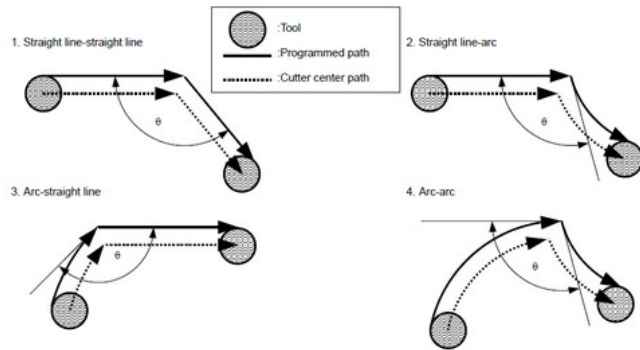

# Automatic Corner Override

## Features

During cutter compensation, the cutting feed is over-ridden at corners while maintaining material removal rates.

This function is a basic function in FANUC Series 0i-MF and 0i-PF.

## Benefits

- Improved tool life
- Improved surface finish
- Improved accuracy

## Ordering Information

Specification	Description
A02B-0323-J891	30i-B Automatic Corner Override
A02B-0326-J891	31i-B5 Automatic Corner Override
A02B-0327-J891	31i-B Automatic Corner Override
A02B-0328-J891	32i-B Automatic Corner Override
A02B-0333-J891	35i-B Automatic Corner Override

### Notice

Certain functions may require additional hardware, different CPU type or additional memory capacity or may cause compatibility issue with other functions. In case of doubt, contact your FANUC sales representative for additional information and support.

The information given in the FANUC manuals or original manufacturer documentation shall prevail. Technical data is subject to change without prior notice. No part of this document may be reproduced in any form. All rights reserved. © FANUC 2017

# 270

## Program Input

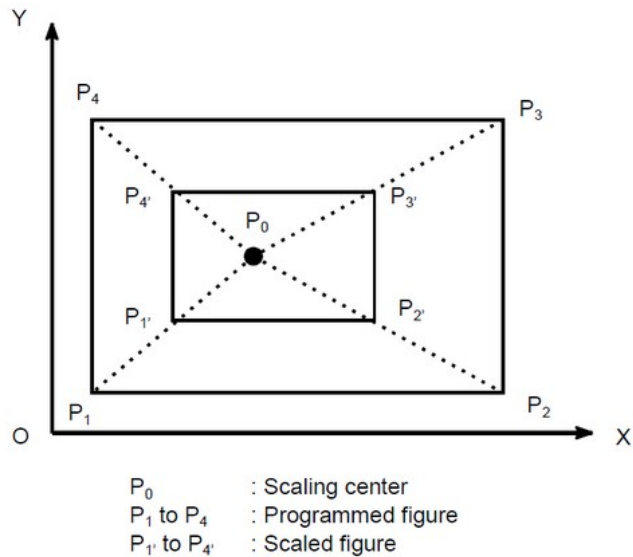

## Scaling

### Features

Scaling is the function that allows the programmed shape to be magnified or reduced in size.

The dimensions specified with X\_, Y\_, and Z\_ can each be scaled up or down with the same or different rates of magnification. The magnification rate can be specified in the program. Unless specified in the program, the magnification rate specified in the parameter is applied.

This function is a basic function in FANUC Series 0i-MF and 0i-PF.

### Benefits

- Reduce program size
- Flexibility in programming
- Easy changes on shop floor
- Programming convenience

### Ordering Information

Specification	Description
A02B-0323-J892	30i-B Scaling
A02B-0326-J892	31i-B5 Scaling
A02B-0327-J892	31i-B Scaling
A02B-0328-J892	32i-B Scaling

### Notice

Certain functions may require additional hardware, different CPU type or additional memory capacity or may cause compatibility issue with other functions. In case of doubt, contact your FANUC sales representative for additional information and support.

The information given in the FANUC manuals or original manufacturer documentation shall prevail. Technical data is subject to change without prior notice. No part of this document may be reproduced in any form. All rights reserved. © FANUC 2017

# 271

## Program Input

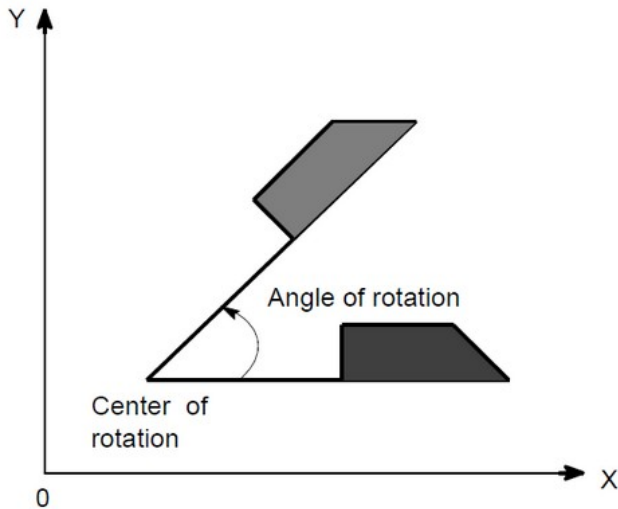

# Coordinate System Rotation

## Features

Programmed shape can be rotated by specifying the pivot point and desired angle.

This function is a basic function in FANUC Series 0i-F.

## Benefits

- Minimize set up time
- Reduce program size
- Flexibility in programming
- No need to line up fixtures/Vise jaws perfectly

## Ordering Information

Specification	Description
A02B-0323-J893	30i-B Coordinate System Rotation
A02B-0326-J893	31i-B5 Coordinate System Rotation
A02B-0327-J893	31i-B Coordinate System Rotation
A02B-0328-J893	32i-B Coordinate System Rotation
A02B-0333-J893	35i-B Coordinate System Rotation

### Notice

Certain functions may require additional hardware, different CPU type or additional memory capacity or may cause compatibility issue with other functions. In case of doubt, contact your FANUC sales representative for additional information and support.

The information given in the FANUC manuals or original manufacturer documentation shall prevail. Technical data is subject to change without prior notice. No part of this document may be reproduced in any form. All rights reserved. © FANUC 2017



# 272

## Program Input

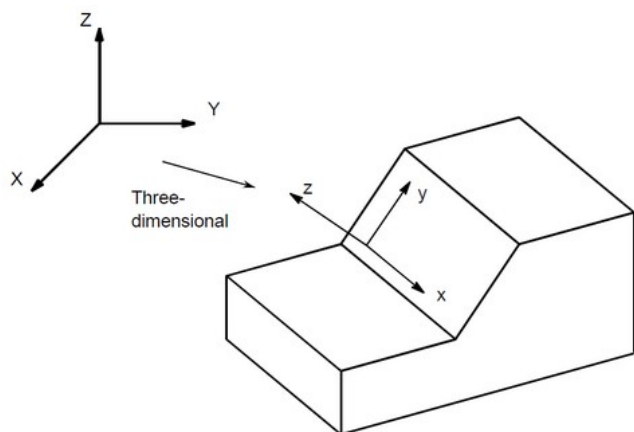

## 3-Dimensional Coordinate System Conversion

### Features

Coordinate conversion about an axis can be carried out if the center of rotation, direction of the axis of rotation, and angular displacement are specified.

This function is very useful in three-dimensional machining by a die-sinking, or similar, machine. For example, by executing a program created on the XY plane after applying 3 Dimensional Coordinate Conversion, machining can be performed on an arbitrary plane in a three-dimensional space.

By specifying rigid tapping in the 3-dimensional coordinate conversion mode, a tapping operation can be performed in the angle direction specified by the 3-dimensional coordinate conversion command (3-dimensional rigid tapping).

### Benefits

- Addition of 3D Coordinate Conversion to the CNC
- Simplification of the programming
- Improvement of the overall machining productivity

### Ordering Information

Specification	Description
A02B-0323-J713	30i-B 3-D Coordinate System Conversion
A02B-0326-J713	31i-B5 3-D Coordinate System Conversion
A02B-0327-J713	31i-B 3-D Coordinate System Conversion
A02B-0328-J713	32i-B 3-D Coordinate System Conversion
A02B-0339-J713	0i-TF 3-Dimensional Coordinate System Conversion
A02B-0340-J713	0i-MF 3-D Coordinate System Conversion

#### Notice

Certain functions may require additional hardware, different CPU type or additional memory capacity or may cause compatibility issue with other functions. In case of doubt, contact your FANUC sales representative for additional information and support.

The information given in the FANUC manuals or original manufacturer documentation shall prevail. Technical data is subject to change without prior notice. No part of this document may be reproduced in any form. All rights reserved. © FANUC 2017

# 273

## Program Input

TILTED WORK PLANE DATA SETTING

LMT N00000

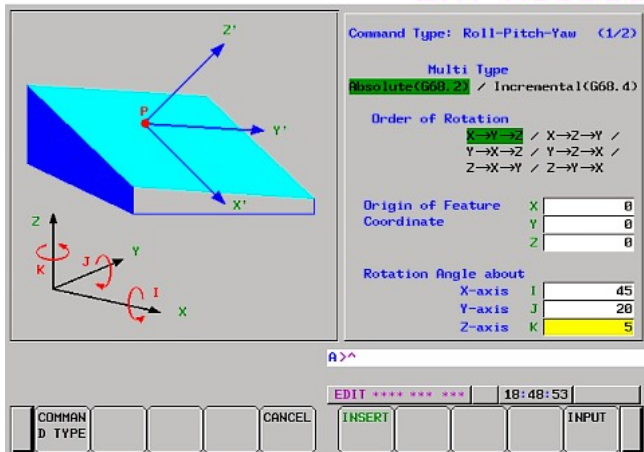

### Notice

Certain functions may require additional hardware, different CPU type or additional memory capacity or may cause compatibility issue with other functions. In case of doubt, contact your FANUC sales representative for additional information and support.

The information given in the FANUC manuals or original manufacturer documentation shall prevail. Technical data is subject to change without prior notice. No part of this document may be reproduced in any form. All rights reserved. © FANUC 2017

# Tilted Working Plane (TWP)

## Features

Tilted Working Plane is used on 5 axes milling machines to define a plane, tilted relative to the machine table. When a figure such as a hole or pocket is cut on a plane, tilted relative to the reference surface of the workpiece, this function defines a coordinate system (referred to a "feature coordinate system") tied to the plane.

When specifying a position in such a coordinate system, a program can be created in a much easier way. A feature coordinate system is defined on a workpiece coordinate system. See the figure below for the relationship between a feature coordinate system and workpiece coordinate system.

This function is applicable to the "table type" machine configuration of the Robodrill.

## Tilted Working Plane Command with Guidance

With this enhancement of the "Tilted Working Plane" command, the following commands can be programmed using a specific graphical screen:

- Euler's Angle
- Roll-Pitch-Yaw
- Three points
- Two vectors
- Projection angles

The guidance screen for tilted working plane command creates a tilted working plane command block after the machine operator has entered tilted working plane data on an interactive screen. With this function, a complicated tilted working plane command block can be easily created.

## Benefits

- Addition of TWP command to the CNC
- Simplification of the programming for 5 axis machines
- Improvement of the overall machining productivity

## Ordering Information

Specification	Description
A02B-0323-R522	30i-B Tilted Working Plane Indexing Command with Guidance
A02B-0326-R522	31i-B5 Tilted Working Plane Indexing Command with Guidance
A02B-0327-R522	31i-B Tilted Working Plane Indexing Command with Guidance

# 274

Specification	Description
A02B-0328-R522	32i-B Tilted Working Plane Indexing Command with Guidance
A02B-0339-R522	0i-TF Tilted Working Plane Indexing Command
A02B-0340-R522	0i-MF Tilted Working Plane Indexing Command

## Notice

Certain functions may require additional hardware, different CPU type or additional memory capacity or may cause compatibility issue with other functions. In case of doubt, contact your FANUC sales representative for additional information and support.

The information given in the FANUC manuals or original manufacturer documentation shall prevail. Technical data is subject to change without prior notice. No part of this document may be reproduced in any form. All rights reserved. © FANUC 2017

# 275

## Program Input

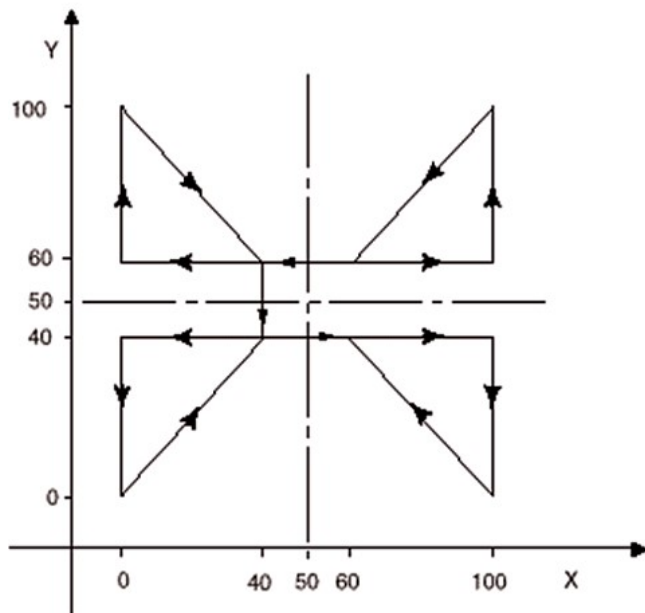

# Programmable Mirror Image

## Features

Programmed shape can be mirror imaged about the axis of symmetry.

This function is a basic function in FANUC Series 0i-F.

## Benefits

- Reduce Program size
- Flexibility in Programming
- Minimize math for creating programs
- Easy changes
- Real part programming convenience

## Ordering Information

Specification	Description
A02B-0323-J880	30i-B Programmable Mirror Image
A02B-0326-J880	31i-B5 Programmable Mirror Image
A02B-0327-J880	31i-B Programmable Mirror Image
A02B-0328-J880	32i-B Programmable Mirror Image

### Notice

Certain functions may require additional hardware, different CPU type or additional memory capacity or may cause compatibility issue with other functions. In case of doubt, contact your FANUC sales representative for additional information and support.

The information given in the FANUC manuals or original manufacturer documentation shall prevail. Technical data is subject to change without prior notice. No part of this document may be reproduced in any form. All rights reserved. © FANUC 2017

# 276

## Program Input

# Figure Copying

---

## Features

Figure Copying is a function that allows machining to be repeated after moving or rotating the figure using a subprogram.

This can save part program storage space as multiple parts can be defined in one part program

## Benefits

- Simplification of the programming
- Improvement of the overall machining productivity

## Ordering Information

Specification	Description
A02B-0323-J897	30i-B Figure Copying
A02B-0326-J897	31i-B5 Figure Copying
A02B-0327-J897	31i-B Figure Copying
A02B-0328-J897	32i-B Figure Copying
A02B-0340-J897	0i-MF Figure Copying

### Notice

Certain functions may require additional hardware, different CPU type or additional memory capacity or may cause compatibility issue with other functions. In case of doubt, contact your FANUC sales representative for additional information and support.

The information given in the FANUC manuals or original manufacturer documentation shall prevail. Technical data is subject to change without prior notice. No part of this document may be reproduced in any form. All rights reserved. © FANUC 2017

# 277

## Program Input

# Tape Format for Series 15 CNC

---

## Features

Tape Format for FS15 allows a control to execute part programs written for the Series 15 control (certain limitations apply).

## Benefits

- Use existing programs created for Series 15 CNC

## Ordering Information

Specification	Description
A02B-0323-J882	30i-B Tape Format of CNC Series 15
A02B-0326-J882	31i-B5 Tape Format of CNC Series 15
A02B-0327-J882	31i-B Tape Format of CNC Series 15
A02B-0328-J882	32i-B Tape Format of CNC Series 15

### Notice

Certain functions may require additional hardware, different CPU type or additional memory capacity or may cause compatibility issue with other functions. In case of doubt, contact your FANUC sales representative for additional information and support.

The information given in the FANUC manuals or original manufacturer documentation shall prevail. Technical data is subject to change without prior notice. No part of this document may be reproduced in any form. All rights reserved. © FANUC 2017

# Macro Executor

---

## Features

Fixed program sequences, machining technology cycles, advanced machining sequences or frequently repeated patterns can be written as sub-programs. These sub-programs are called Macro Programs.

Macro Programs are written using an advanced extended language and structure; they also feature parameters and variables.

The Macro Programs (also called P-CODE Macro) are compiled in executable code using the Macro Compiler (refer to the software section of this catalogue for further details about the compiler).

The Macro Executor function provides to the CNC the capability to run the Macro Programs. Macro Programs are divided in 3 categories:

- Execution Macro functions
- Conversational Macro functions
- Auxiliary Macro functions

## Execution Macro function

The Execution Macro function calls and executes the Macro Programs (P-CODE macro) from the Parts Program of the CNC using different methods (G, M, T or specific code as well as a program call).

## Conversational Macro function

When the Conversational Macro function key is pressed on the MDI, the conversational macro function calls and executes a special macro program which is specialized in processing screens (conversational macro). The screen displayed by the program is called the conventional macro screen or user screen.

## Auxiliary Macro function

At power-on, the Auxiliary Macro function calls and executes a macro program for performing auxiliary processing (auxiliary macro).

## Benefits

- High speed execution: a macro program run as compiled executable and is fast, so that machining time can be reduced and machining precision can be improved.
- The P-CODE is stored in the CNC Flash ROM (F-ROM); it provides additional safety and reliability.

### Notice

Certain functions may require additional hardware, different CPU type or additional memory capacity or may cause compatibility issue with other functions. In case of doubt, contact your FANUC sales representative for additional information and support.

The information given in the FANUC manuals or original manufacturer documentation shall prevail. Technical data is subject to change without prior notice. No part of this document may be reproduced in any form. All rights reserved. © FANUC 2017

- A program compiled to the execution format cannot be displayed on the CNC program screen, so that the know-how related to the cycles can be protected.
- The user can call the execution Macro program with an easy call procedure
- An original screen can be created using graphic display. Screens can be selected by the use of soft keys.
- Possibility to create advanced machining cycles, interactive screens for operators, communication management, etc.
- Improvement of the machine efficiency and productivity

## Ordering Information

Specification	Description
A02B-0323-J888	30i-B Macro Executor
A02B-0326-J888	31i-B5 Macro Executor
A02B-0327-J888	31i-B Macro Executor
A02B-0328-J888	32i-B Macro Executor
A02B-0329-J888	30i-LB Macro Executor
A02B-0330-J888	31i-LB Macro Executor
A02B-0331-J888	30i-PB Macro Executor
A02B-0332-J888	31i-PB Macro Executor
A02B-0333-R705	35i-B Macro Executor - Incl. Custom Software Size 512 kB
A02B-0334-R705	PM i-A Macro Executor
A02B-0339-J888	0i-TF Macro Executor
A02B-0340-J888	0i-MF Macro Executor

### Notice

Certain functions may require additional hardware, different CPU type or additional memory capacity or may cause compatibility issue with other functions. In case of doubt, contact your FANUC sales representative for additional information and support.

The information given in the FANUC manuals or original manufacturer documentation shall prevail. Technical data is subject to change without prior notice. No part of this document may be reproduced in any form. All rights reserved. © FANUC 2017



# 280

## Program Input

# Extended Conversational Macro Function

## Features

With the Extended Conversational Macro function, a set of macro instructions are available to improve the flexibility of the screen display / management.

## Overview of the functions

- Window display
- Display of external characters at any position
- Display of 2-by-2 characters
- Shift and scale in the graphical coordinate system

## Benefits

- Simplifies the programming of complex Human Machine Interfaces

## Ordering Information

Specification	Description
A02B-0323-S798	30i-B Extended Conversational Macro Function
A02B-0326-S798	31i-B5 Extended Conversational Macro Function
A02B-0327-S798	31i-B Extended Conversational Macro Function
A02B-0328-S798	32i-B Extended Conversational Macro Function
A02B-0339-S798	0i-TF Extended Conversational Macro Function
A02B-0340-S798	0i-MF Extended Conversational Macro Function

### Notice

Certain functions may require additional hardware, different CPU type or additional memory capacity or may cause compatibility issue with other functions. In case of doubt, contact your FANUC sales representative for additional information and support.

The information given in the FANUC manuals or original manufacturer documentation shall prevail. Technical data is subject to change without prior notice. No part of this document may be reproduced in any form. All rights reserved. © FANUC 2017

# 281

## Program Input

# Macro Executor + C-Language Executor

---

## Features

### Macro Executor

Fixed program sequences, machining technology cycles, advanced machining sequences or frequently repeated patterns can be written as sub-programs. These sub-programs are called Macro Programs.

Macro Programs are written using an advanced extended language and structure; they also feature parameters and variable.

The Macro programs (also called P-CODE Macro) are compiled in executable code using the Macro Compiler (refer to the software section of this catalogue for further details about the compiler).

The Macro Executor function provides to the CNC the capability to run the Macro Programs. Macro Programs are divided in 3 categories:

- Execution Macro functions
- Conversational Macro functions
- Auxiliary Macro functions

#### Execution Macro function

The Execution Macro function calls and executes the Macro Programs (P-CODE macro) from the Parts Program of the CNC using different methods (G, M, T or specific code as well as a program call).

#### Conversational Macro function

When the Conversational Macro function key is pressed on the MDI, the conversational macro function calls and executes a special macro program which is specialized in processing screens (conversational macro). The screen displayed by the program is called the conventional macro screen or user screen.

#### Auxiliary Macro function

At power-on, the Auxiliary Macro function calls and executes a macro program for performing auxiliary processing (auxiliary macro).

### C-language Executor

The C-language executor function is used to customize screen display and implement a mechanism for user-specific operation as with the macro executor function. Instead of macro statements, application programs for display and operation can be created using the general C programming language. It also has all the benefits of the Macro executor.

#### Notice

Certain functions may require additional hardware, different CPU type or additional memory capacity or may cause compatibility issue with other functions. In case of doubt, contact your FANUC sales representative for additional information and support.

The information given in the FANUC manuals or original manufacturer documentation shall prevail. Technical data is subject to change without prior notice. No part of this document may be reproduced in any form. All rights reserved. © FANUC 2017

C-Language executor requires the selection of an amount of Custom Software Size storage space between 256kB and 12MB in the Flash Rom (F-ROM). The size of the memory depends on the CNC type and the options selected.

## Benefits

- High speed execution: a macro program run as compiled executable and is fast, so that machining time can be reduced and machining precision can be improved.
- The P-CODE is stored in the CNC Flash ROM (F-ROM); it provides additional safety and reliability.
- A program compiled to the execution format cannot be displayed on the CNC program screen, so that the know-how related to the cycles can be protected.
- The user can call the execution Macro program with an easy call procedure
- An original screen can be created using graphic display. Screens can be selected by the use of soft keys.
- Possibility to create advanced machining cycles, interactive screens for operators, communication management, etc.

## Ordering Information

Specification	Description
A02B-0323-J734	30i-B Macro Executor and C-Language Executor
A02B-0326-J734	31i-B5 Macro Executor and C-Language Executor
A02B-0327-J734	31i-B Macro Executor and C-Language Executor
A02B-0328-J734	32i-B Macro Executor and C-Language Executor
A02B-0329-J734	30i-LB Macro Executor and C-Language Executor
A02B-0330-J734	31i-LB Macro Executor and C-Language Executor
A02B-0331-J734	30i-PB Macro Executor and C-Language Executor
A02B-0332-J734	31i-PB Macro Executor and C-Language Executor
A02B-0333-R706	35i-B Macro Executor and C-Language Executor - Incl. C-Language Executor Additional SRAM, Custom Software Size 2 MB
A02B-0334-R706	PM i-A Macro Executor and C-Language Executor
A02B-0339-J734	0i-TF Macro and C-Language Executor
A02B-0340-J734	0i-MF Macro and C-Language Executor

### Notice

Certain functions may require additional hardware, different CPU type or additional memory capacity or may cause compatibility issue with other functions. In case of doubt, contact your FANUC sales representative for additional information and support.

The information given in the FANUC manuals or original manufacturer documentation shall prevail. Technical data is subject to change without prior notice. No part of this document may be reproduced in any form. All rights reserved. © FANUC 2017

# 283

## Program Input

# C Language Executor Additional SRAM

## Features

If the Static Random Access Memory (SRAM) area required for applications created with the C-language executor exceeds the standard size, which is 63K bytes, the SRAM area can optionally be expanded to up to 255K bytes.

The memory of the Series 0i-D CNC can be extended to a maximum of 192K bytes.

## Benefits

- Addition of additional processing memory for C-Language
- Increase of the processing capabilities
- Improvement of the overall machining productivity

## Ordering Information

Specification	Description
A02B-0323-J736	30i-B C-Language Executor, Additional SRAM
A02B-0326-J736	31i-B5 C-Language Executor, Additional SRAM
A02B-0327-J736	31i-B C-Language Executor, Additional SRAM
A02B-0328-J736	32i-B C-Language Executor, Additional SRAM
A02B-0333-J736	35i-B C-Language Executor, Additional SRAM
A02B-0339-J736	0i-TF C-Language Executor Additional SRAM 256 kB
A02B-0339-S827	0i-TF C-Language Executor Additional SRAM 512 kB
A02B-0340-J736	0i-MF C-Language Executor Additional SRAM 256 kB
A02B-0340-S827	0i-MF C-Language Executor Additional SRAM 512 kB

### Notice

Certain functions may require additional hardware, different CPU type or additional memory capacity or may cause compatibility issue with other functions. In case of doubt, contact your FANUC sales representative for additional information and support.

The information given in the FANUC manuals or original manufacturer documentation shall prevail. Technical data is subject to change without prior notice. No part of this document may be reproduced in any form. All rights reserved. © FANUC 2017

# 284

## Program Input

# Middle-Level Task for C-Language Executor

## Features

Middle-Level Task is the independent task of C Language Executor ordinary tasks (Main Task, Auxiliary Tasks and Window Task), and is a task executed at a constant start interval.

The processing time of Middle-Level Task is divided from the processing time allocated in High-Level Task according to the parameter, and Middle-Level Task can be executed as a task in addition to High-Level Task.

Start interval of Middle-Level Task can be selected by the parameter while the start interval of a High-Level Task is constant.

## Benefits

- Addition of additional task management capabilities for the C-Language Executor
- Improvement of the overall machining productivity

## Ordering Information

Specification	Description
A02B-0323-R550	30i-B Middle-Level Task of C-Language Executor
A02B-0326-R550	31i-B5 Middle-Level Task of C-Language Executor
A02B-0327-R550	31i-B Middle-Level Task of C-Language Executor
A02B-0328-R550	32i-B Middle-Level Task of C-Language Executor
A02B-0333-R550	35i-B Middle-Level Task of C-Language Executor
A02B-0334-R550	PM i-A Middle-Level Task of C-Language Executor

### Notice

Certain functions may require additional hardware, different CPU type or additional memory capacity or may cause compatibility issue with other functions. In case of doubt, contact your FANUC sales representative for additional information and support.

The information given in the FANUC manuals or original manufacturer documentation shall prevail. Technical data is subject to change without prior notice. No part of this document may be reproduced in any form. All rights reserved. © FANUC 2017

# 285

## Program Input

# Custom Software Size

## Features

Custom Software Size is the size of custom software that can be used from the Macro Executor and C-Language Executor programs.

When a multi-path system is used, the total size required for all paths needs to be selected. This amount of space is reserved in the systems Flash-ROM (FROM) memory.

## Benefits

- Addition of additional storage memory for C-Language
- Increase of the processing capabilities
- Improvement of the overall machining productivity

## Ordering Information

Specification	Description
A02B-0323-J738#12M	30i-B Custom Software Size Main CPU, 12 MB
A02B-0323-J738#16M	30i-B Custom Software Size, 16 MB
A02B-0323-J738#2M	30i-B Custom Software Size Main CPU, 2 MB
A02B-0323-J738#4M	30i-B Custom Software Size Main CPU, 4 MB
A02B-0323-J738#512K	30i-B Custom Software Size Main CPU, 512 kB
A02B-0323-J738#6M	30i-B Custom Software Size Main CPU, 6 MB
A02B-0323-J738#8M	30i-B Custom Software Size Main CPU, 8 MB
A02B-0326-J738#12M	31i-B5 Custom Software Size Main CPU, 12 MB
A02B-0326-J738#16M	31i-B5 Custom Software Size, 16 MB
A02B-0326-J738#2M	31i-B5 Custom Software Size Main CPU, 2 MB
A02B-0326-J738#4M	31i-B5 Custom Software Size Main CPU, 4 MB
A02B-0326-J738#512K	31i-B5 Custom Software Size Main CPU, 512 kB
A02B-0326-J738#6M	31i-B5 Custom Software Size Main CPU, 6 MB
A02B-0326-J738#8M	31i-B5 Custom Software Size Main CPU, 8 MB
A02B-0327-J738#12M	31i-B Custom Software Size Main CPU, 12 MB
A02B-0327-J738#16M	31i-B Custom Software Size, 16 MB
A02B-0327-J738#2M	31i-B Custom Software Size Main CPU, 2 MB
A02B-0327-J738#4M	31i-B Custom Software Size Main CPU, 4 MB
A02B-0327-J738#512K	31i-B Custom Software Size Main CPU, 512 kB
A02B-0327-J738#6M	31i-B Custom Software Size Main CPU, 6 MB

### Notice

Certain functions may require additional hardware, different CPU type or additional memory capacity or may cause compatibility issue with other functions. In case of doubt, contact your FANUC sales representative for additional information and support.

The information given in the FANUC manuals or original manufacturer documentation shall prevail. Technical data is subject to change without prior notice. No part of this document may be reproduced in any form. All rights reserved. © FANUC 2017

Specification	Description
A02B-0327-J738#8M	31i-B Custom Software Size Main CPU, 8 MB
A02B-0328-J738#12M	32i-B Custom Software Size Main CPU, 12 MB
A02B-0328-J738#16M	32i-B Custom Software Size, 16 MB
A02B-0328-J738#2M	32i-B Custom Software Size Main CPU, 2 MB
A02B-0328-J738#4M	32i-B Custom Software Size Main CPU, 4 MB
A02B-0328-J738#512K	32i-B Custom Software Size Main CPU, 512 kB
A02B-0328-J738#6M	32i-B Custom Software Size Main CPU, 6 MB
A02B-0328-J738#8M	32i-B Custom Software Size Main CPU, 8 MB
A02B-0333-J738#12M	35i-B Custom Software Size Main CPU, 12 MB
A02B-0333-J738#2M	35i-B Custom Software Size Main CPU, 2 MB
A02B-0333-J738#4M	35i-B Custom Software Size Main CPU, 4 MB
A02B-0333-J738#6M	35i-B Custom Software Size Main CPU, 6 MB
A02B-0333-J738#8M	35i-B Custom Software Size Main CPU, 8 MB
A02B-0334-J738#12M	PM i-A Custom Software Size, 12 MB
A02B-0334-J738#2M	PM i-A Custom Software Size, 2 MB
A02B-0334-J738#4M	PM i-A Custom Software Size, 4 MB
A02B-0334-J738#6M	PM i-A Custom Software Size, 6 MB
A02B-0334-J738#8M	PM i-A Custom Software Size, 8 MB
A02B-0339-J738#12M	0i-TF Custom Software Size: 12 MB
A02B-0339-J738#16M	0i-TF Custom Software Size: 16 MB
A02B-0339-J738#2M	0i-TF Custom Software Size: 2 MB
A02B-0339-J738#4M	0i-TF Custom Software Size: 4 MB
A02B-0339-J738#512K	0i-TF Custom Software Size: 512 kB
A02B-0339-J738#6M	0i-TF Custom Software Size: 6 MB
A02B-0339-J738#8M	0i-TF Custom Software Size: 8 MB
A02B-0340-J738#12M	0i-MF Custom Software Size: 12 MB
A02B-0340-J738#16M	0i-MF Custom Software Size: 16 MB
A02B-0340-J738#2M	0i-MF Custom Software Size: 2 MB
A02B-0340-J738#4M	0i-MF Custom Software Size: 4 MB
A02B-0340-J738#512K	0i-MF Custom Software Size: 512 kB
A02B-0340-J738#6M	0i-MF Custom Software Size: 6 MB
A02B-0340-J738#8M	0i-MF Custom Software Size: 8 MB

#### Notice

Certain functions may require additional hardware, different CPU type or additional memory capacity or may cause compatibility issue with other functions. In case of doubt, contact your FANUC sales representative for additional information and support.

The information given in the FANUC manuals or original manufacturer documentation shall prevail. Technical data is subject to change without prior notice. No part of this document may be reproduced in any form. All rights reserved. © FANUC 2017

# 287

## Program Input

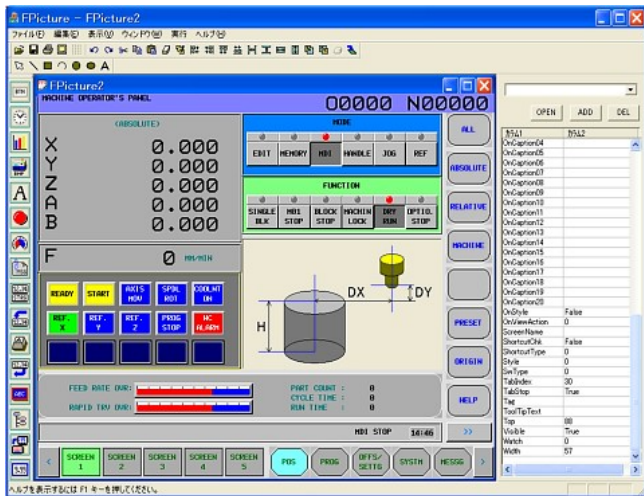

### Notice

Certain functions may require additional hardware, different CPU type or additional memory capacity or may cause compatibility issue with other functions. In case of doubt, contact your FANUC sales representative for additional information and support.

The information given in the FANUC manuals or original manufacturer documentation shall prevail. Technical data is subject to change without prior notice. No part of this document may be reproduced in any form. All rights reserved. © FANUC 2017

# FANUC PICTURE Executor

## Features

FANUC PICTURE Executor is a function in the CNC allowing the execution of HMI projects created by the FANUC PICTURE for Windows® software. This function is intended to be used if the C-language executor is used in the CNC at the same time. If no C-language executor is used, the FANUC PICTURE function should be used instead. The required custom software size has to be ordered separately.

FANUC PICTURE provides an easy way to create custom operator and HMI screens to drive a complex process. The screens are created using a development software called FANUC PICTURE for Windows®. The software has all the functions and features of modern HMI software tools, supports objects, animations, data, multi-language and also feature a macro language to run routines to perform tasks.

The screens are compiled and stored in the CNC Flash-ROM (FROM) memory and are rendered directly by the CNC without requiring any Windows operating system or runtime.

FANUC PICTURE supports multi-language projects; on multi-language projects, the language of the HMI application can be switched on the fly by the operator.

## Benefits

- Easy screen customization capabilities
- Simplification of the operator work on production machine
- Reduction of operation error on production machines
- Simplification of the machine and process control
- Improvement of the overall machine or production line productivity

## Ordering Information

Specification	Description
A02B-0323-R644	30i-B FANUC PICTURE Executor
A02B-0326-R644	31i-B5 FANUC PICTURE Executor
A02B-0327-R644	31i-B FANUC PICTURE Executor
A02B-0328-R644	32i-B FANUC PICTURE Executor
A02B-0333-R644	35i-B FANUC PICTURE Executor
A02B-0334-R644	PM i-A FANUC PICTURE Executor
A02B-0339-R644	0i-TF FANUC Picture Executor
A02B-0340-R644	0i-MF FANUC Picture Executor



# 288

## Program Input

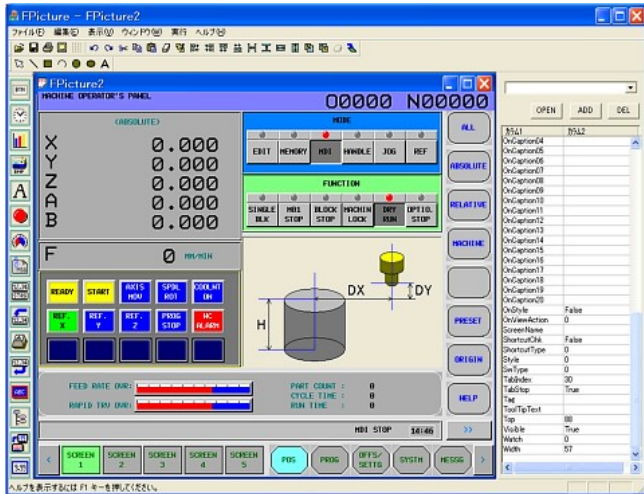

### Notice

Certain functions may require additional hardware, different CPU type or additional memory capacity or may cause compatibility issue with other functions. In case of doubt, contact your FANUC sales representative for additional information and support.

The information given in the FANUC manuals or original manufacturer documentation shall prevail. Technical data is subject to change without prior notice. No part of this document may be reproduced in any form. All rights reserved. © FANUC 2017

# FANUC PICTURE Function

## Features

The FANUC PICTURE function allows the execution of HMI projects in the CNC which are created by the FANUC PICTURE for Windows® software. FANUC PICTURE function includes 6MB of custom software size to store the compiled screens in the CNC. This function cannot be used together with the C-language executor function in the CNC. In case of this, the FANUC PICTURE executor should be used instead.

FANUC PICTURE provides an easy way to create custom operator and HMI screens to drive a complex process. The screens are created using a development software called FANUC PICTURE for Windows®. The software has all the functions and features of modern HMI software tools, supports objects, animations, data, multi-language and also feature a macro language to run routines to perform tasks.

The screens are compiled and stored in the CNC Flash-ROM (FROM) memory and are rendered directly by the CNC without requiring any Windows operating system or runtime.

FANUC PICTURE supports multi-language projects; on multi-language projects, the language of the HMI application can be switched on the fly by the operator.

## Benefits

- Easy screen customization capabilities
- Simplification of the operator work on production machine
- Reduction of operation error on production machines
- Simplification of the machine and process control
- Improvement of the overall machine or production line productivity

## Ordering Information

Specification	Description
A02B-0323-S879	30i-B FANUC PICTURE Function - Touch Panel Display
A02B-0323-S944	30i-B FANUC PICTURE Function - Non-Touch Panel Display
A02B-0326-S879	31i-B5 FANUC PICTURE Function - Touch Panel Display
A02B-0326-S944	31i-B5 FANUC PICTURE Function - Non-Touch Panel Display
A02B-0327-S879	31i-B FANUC PICTURE Function - Touch Panel Display
A02B-0327-S944	31i-B FANUC PICTURE Function - Non-Touch Panel Display
A02B-0328-S879	32i-B FANUC PICTURE Function - Touch Panel Display
A02B-0328-S944	32i-B FANUC PICTURE Function - Non-Touch Panel Display
A02B-0339-S879	0i-TF FANUC Picture Function
A02B-0339-S944	0i-TF FANUC Picture Function for Non-Touch Panel Display

# 289

Specification	Description
A02B-0340-S879	0i-MF FANUC Picture Function
A02B-0340-S944	0i-MF FANUC Picture Function for Non-Touch Panel Display

#### Notice

Certain functions may require additional hardware, different CPU type or additional memory capacity or may cause compatibility issue with other functions. In case of doubt, contact your FANUC sales representative for additional information and support.

The information given in the FANUC manuals or original manufacturer documentation shall prevail. Technical data is subject to change without prior notice. No part of this document may be reproduced in any form. All rights reserved. © FANUC 2017

# 290

## Program Input

# FANUC PICTURE Function for Series 35i

## Features

The FANUC PICTURE function for Series 35i allows the execution of HMI projects in the CNC which are created by the FANUC PICTURE for Windows® software. FANUC PICTURE function for Series 35i includes the following options:

- 6 MB custom software size
- FANUC PICTURE executor
- Touch panel control
- Virtual MDI key

FANUC PICTURE provides an easy way to create custom operator and HMI screens to drive a complex process. The screens are created using a development software called FANUC PICTURE for Windows. The software has all the functions and features of modern HMI software tools, supports objects, animations, data, multi-language and also feature a macro language to run routines to perform tasks.

The screens are compiled and stored in the CNC F-ROM memory and are rendered directly by the CNC without requiring any Windows operating system or runtime.

FANUC PICTURE supports multi-language projects which can be switched on the fly.

## Benefits

- Easy screen customization capabilities
- Simplification of the operator work on production machine
- Reduction of operation error on production machines
- Simplification of the machine and process control
- Improvement of the overall machine or production line productivity

## Ordering Information

Specification	Description
A02B-0333-R708	35i-B FANUC PICTURE Function - Touch Panel Display

### Notice

Certain functions may require additional hardware, different CPU type or additional memory capacity or may cause compatibility issue with other functions. In case of doubt, contact your FANUC sales representative for additional information and support.

The information given in the FANUC manuals or original manufacturer documentation shall prevail. Technical data is subject to change without prior notice. No part of this document may be reproduced in any form. All rights reserved. © FANUC 2017

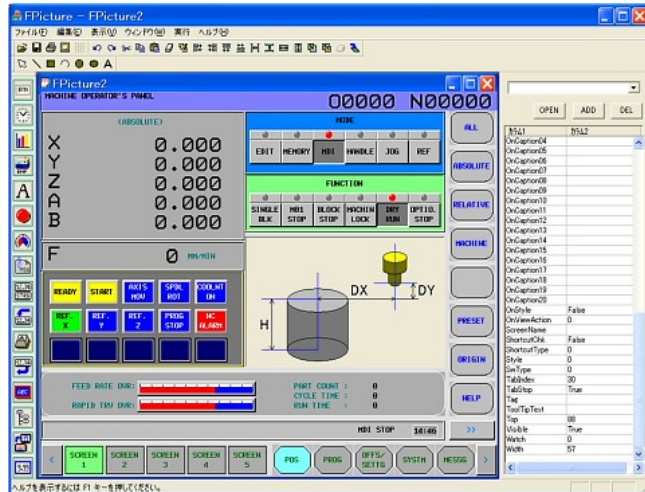

# 291

## Program Input

# FANUC PICTURE Function for Power Motion i

## Features

The FANUC PICTURE function for Power Motion i allows the execution of HMI projects in the CNC which are created by the FANUC PICTURE for Windows® software. FANUC PICTURE function for Power Motion i includes the following options:

- 6 MB custom software size
- FANUC PICTURE executor
- Touch panel control
- Virtual MDI key

FANUC PICTURE provides an easy way to create custom operator and HMI screens to drive a complex process. The screens are created using a development software called FANUC PICTURE for Windows. The software has all the functions and features of modern HMI software tools, supports objects, animations, data, multi-language and also feature a macro language to run routines to perform tasks.

The screens are compiled and stored in the CNC F-ROM memory and are rendered directly by the CNC without requiring any Windows operating system or runtime.

FANUC PICTURE supports multi-language projects which can be switched on the fly.

## Benefits

- Easy screen customization capabilities
- Simplification of the operator work on production machine
- Reduction of operation error on production machines
- Simplification of the machine and process control
- Improvement of the overall machine or production line productivity

## Ordering Information

Specification	Description
A02B-0334-R708	PM i-A FANUC PICTURE Function - Touch Panel Display

### Notice

Certain functions may require additional hardware, different CPU type or additional memory capacity or may cause compatibility issue with other functions. In case of doubt, contact your FANUC sales representative for additional information and support.

The information given in the FANUC manuals or original manufacturer documentation shall prevail. Technical data is subject to change without prior notice. No part of this document may be reproduced in any form. All rights reserved. © FANUC 2017

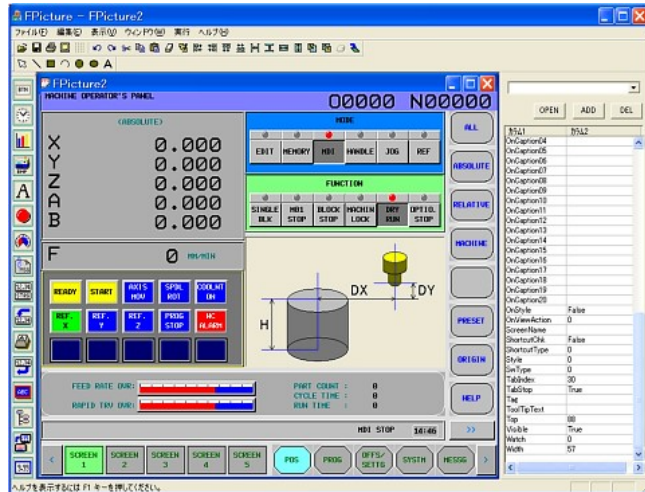

## Embedded Macro

### Features

This function protects a program created by a machine tool builder, by storing the program in an exclusive folder to embedded macros (hereinafter referred to as an MTB1 folder) and assigning an attribute to the folder.

At the same time, the following functions are available:

- An exclusive program memory capacity of 100K bytes (corresponding to about 260 m) is provided in addition the ordinary program memory capacity. The number of registerable programs remains unchanged from the ordinary number of registerable programs.
- Attributes such as edit lock and edit/display lock can be assigned to the MTB1 folder. In addition, a set values can be locked using an exclusive password.
- A program stored in the MTB1 folder can be called based on a M/T codes or G code; subprogram can be called using M code.
- Custom macro common variables (#200 to #499) are added.

### Benefits

- Protection of programs

### Ordering Information

Specification	Description
A02B-0323-S652#128K	30i-B Embedded Macro, 128 kB
A02B-0326-S652#128K	31i-B5 Embedded Macro, 128 kB
A02B-0327-S652#128K	31i-B Embedded Macro, 128 kB
A02B-0328-S652#128K	32i-B Embedded Macro, 128 kB
A02B-0339-S652#128K	0i-TF Embedded Macro
A02B-0340-S652#128K	0i-MF Embedded Macro

#### Notice

Certain functions may require additional hardware, different CPU type or additional memory capacity or may cause compatibility issue with other functions. In case of doubt, contact your FANUC sales representative for additional information and support.

The information given in the FANUC manuals or original manufacturer documentation shall prevail. Technical data is subject to change without prior notice. No part of this document may be reproduced in any form. All rights reserved. © FANUC 2017

# 293

## Program Input

G83 X\_ Y\_ Z\_ R\_ Q\_ F\_ L\_ K\_ P\_ ;

X\_ Y\_ : Hole position data

Z\_ : Distance from point R to the bottom of the hole

R\_ : Distance from the initial level to point R

Q\_ : Depth of each cut

F\_ : Cutting feedrate

L\_ : Forward or backward traveling speed (same format as F above)

(If this is omitted, the values in parameters No.5172 and No.5173 are assumed as defaults.)

K\_ : Number of times the operation is repeated (if required)

P\_ : Dwell time at the bottom of the hole

(If this is omitted, P0 is assumed as the default.)

G83 (G98)

G83 (G99)

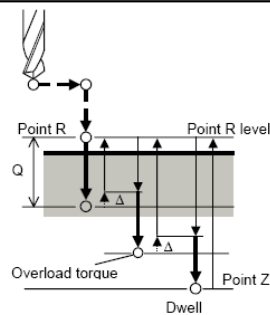
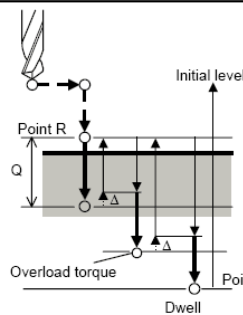

Δ: Initial clearance when the tool is retracted to point R and the clearance from the bottom of the hole in the second or subsequent drilling (parameter 5174)

Q: Depth of each cut

→ Path along which the tool travels at the rapid traverse rate

→ Path along which the tool travels at the programmed cutting feedrate

→ Path along which the tool travels at the forward or backward rate during the cycle specified with parameters

### Notice

Certain functions may require additional hardware, different CPU type or additional memory capacity or may cause compatibility issue with other functions. In case of doubt, contact your FANUC sales representative for additional information and support.

The information given in the FANUC manuals or original manufacturer documentation shall prevail. Technical data is subject to change without prior notice. No part of this document may be reproduced in any form. All rights reserved. © FANUC 2017

# Small-Hole Peck Drilling Cycle

## Features

The Small-Hole Peck Drilling Cycle performs a drilling operation that periodically retracts the tool above the parts surface (to a clearance position) to clear chips or flood the hole with coolant until the desired hole depth is reached.

This function is a basic function in FANUC Series 0i-MF.

## Benefits

- Simplified Programming

## Ordering Information

Specification	Description
A02B-0323-J896	30i-B Small-Hole Peck Drilling Cycle
A02B-0326-J896	31i-B5 Small Hole Peck Drilling Cycle
A02B-0327-J896	31i-B Small Hole Peck Drilling Cycle
A02B-0328-J896	32i-B Small Hole Peck Drilling Cycle
A02B-0333-J896	35i-B Small Hole Peck Drilling Cycle

# 294

## Program Input

Traverse grinding cycle  
(G71, G72)

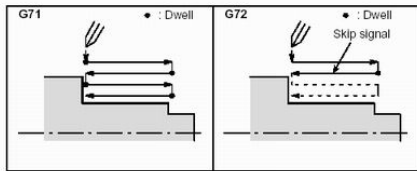

Oscillating grinding cycle  
(G73, G74)

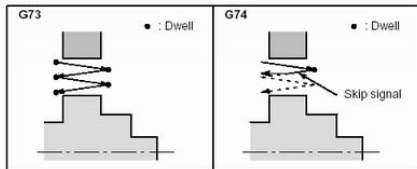

# Canned Cycles for Grinding

## Features

Canned Cycles for Grinding provides an easier way for the programmer to create programs for grinding.

With a canned grinding cycle, repetitive operations peculiar to grinding can be specified in a single block with a G function. The repetitive machining specific to grinding can be specified by one block. Since four types of canned cycles are provided for grinding, programming is simplified.

## Benefits

- Simplified Programming

## Ordering Information

Specification	Description
A02B-0323-S974	30i-B Canned Cycle for Grinding
A02B-0326-S974	31i-B5 Canned Cycle for Grinding
A02B-0327-S974	31i-B Canned Cycle for Grinding
A02B-0328-S974	32i-B Canned Cycle for Grinding

### Notice

Certain functions may require additional hardware, different CPU type or additional memory capacity or may cause compatibility issue with other functions. In case of doubt, contact your FANUC sales representative for additional information and support.

The information given in the FANUC manuals or original manufacturer documentation shall prevail. Technical data is subject to change without prior notice. No part of this document may be reproduced in any form. All rights reserved. © FANUC 2017

# 295

## Program Input

# Real Time Custom Macro

## Features

Used with an NC program, the real time custom macro function controls peripheral axes and signals.

If a macro statement is used together with an NC statement, a program using the conventional custom macro function executes the macro statement immediately when the macro statement is read. So, the macro statement cannot be executed independently of the NC statement.

On the other hand, the real time custom macro function enables the following control operations when a real time macro command (RTM command) is coded in an NC program.

## Key functions

- A real time macro command starts operation in synchronism with the NC statement and is executed independently. During NC program execution, a real time macro command can be executed at the same time.
- PMC interface signals can be read and written (with a restriction). In an NC program, a motion using a signal as a trigger can be coded
- Variables dedicated to a real time macro command can be read and written
- A real time macro command can exercise axis control
- Multiple real time macro commands can be executed at the same time. Multiple real time custom macro statements can be coded in an NC program and can be controlled independently of each other

## Benefits

- Simplified Programming

## Ordering Information

Specification	Description
A02B-0323-S842	30i-B Real Time Custom Macro
A02B-0326-S842	31i-B5 Real Time Custom Macro
A02B-0327-S842	31i-B Real Time Custom Macro
A02B-0328-S842	32i-B Real Time Custom Macro
A02B-0339-S842	0i-TF Real Time Custom Macro
A02B-0340-S842	0i-MF Real Time Custom Macro

### Notice

Certain functions may require additional hardware, different CPU type or additional memory capacity or may cause compatibility issue with other functions. In case of doubt, contact your FANUC sales representative for additional information and support.

The information given in the FANUC manuals or original manufacturer documentation shall prevail. Technical data is subject to change without prior notice. No part of this document may be reproduced in any form. All rights reserved. © FANUC 2017



# 296

## Program Input

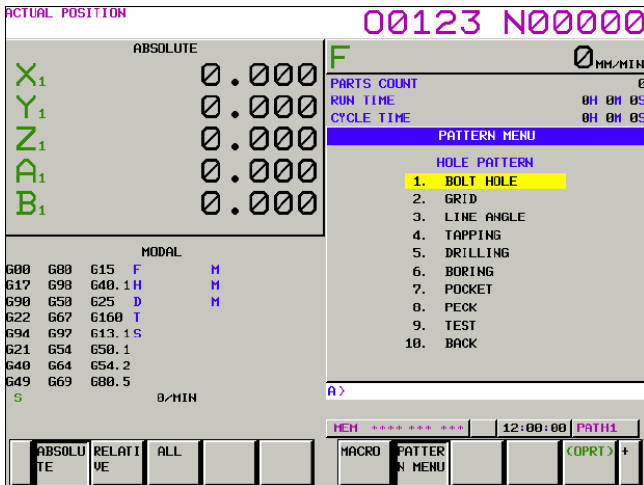

### Notice

Certain functions may require additional hardware, different CPU type or additional memory capacity or may cause compatibility issue with other functions. In case of doubt, contact your FANUC sales representative for additional information and support.

The information given in the FANUC manuals or original manufacturer documentation shall prevail. Technical data is subject to change without prior notice. No part of this document may be reproduced in any form. All rights reserved. © FANUC 2017

# Pattern Data Input

## Features

With the Pattern Data Input function, a part program can be created from a selected menu with the possibility to enter data on conversational screens.

This function is a basic function in FANUC Series 0i-MF and 0i-TF.

## Benefits

- No need for extensive G code knowledge
- Conversational screens for standard cycles
- Simplifies part programming

## Ordering Information

Specification	Description
A02B-0323-J884	30i-B Pattern Data Input
A02B-0326-J884	31i-B5 Pattern Data Input
A02B-0327-J884	31i-B Pattern Data Input
A02B-0328-J884	32i-B Pattern Data Input

# 297

## Program Input

# M-Code Protect Function

---

## Features

Execution of some specific M-codes (miscellaneous function) is permitted only when commanded in the macro program which is called as macro.

With this function, specific M-codes, which are used in the macro program for machine control, can be protected from the illegal use in user machining program.

## Benefits

- Simplified Programming

## Ordering Information

Specification	Description
A02B-0323-R594	30i-B M-Code Protect Function
A02B-0326-R594	31i-B5 M-Code Protect Function
A02B-0327-R594	31i-B M-Code Protect Function
A02B-0328-R594	32i-B M-Code Protect Function
A02B-0339-R594	0i-TF M-Code Protect Function
A02B-0340-R594	0i-MF M-Code Protect Function

### Notice

Certain functions may require additional hardware, different CPU type or additional memory capacity or may cause compatibility issue with other functions. In case of doubt, contact your FANUC sales representative for additional information and support.

The information given in the FANUC manuals or original manufacturer documentation shall prevail. Technical data is subject to change without prior notice. No part of this document may be reproduced in any form. All rights reserved. © FANUC 2017

# 298

## Program Input

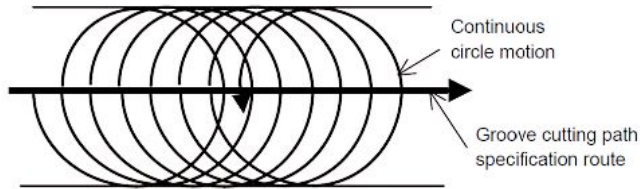

# Groove Cutting Function by Continuous Circle Movement

## Features

Groove cutting with a width greater than the tool diameter can be performed by causing the tool to make continuous circle motion independently of axis movement by the groove cutting path program and superposing the continuous circle motion on the axis movement by the groove cutting path program.

## Benefits

- Simplification of the programming

## Ordering Information

Specification	Description
A02B-0323-S854	30i-B Groove Cutting Function by Continuous Circle Movement
A02B-0326-S854	31i-B5 Groove Cutting Function by Continuous Circle Movement
A02B-0327-S854	31i-B Groove Cutting Function by Continuous Circle Movement

### Notice

Certain functions may require additional hardware, different CPU type or additional memory capacity or may cause compatibility issue with other functions. In case of doubt, contact your FANUC sales representative for additional information and support.

The information given in the FANUC manuals or original manufacturer documentation shall prevail. Technical data is subject to change without prior notice. No part of this document may be reproduced in any form. All rights reserved. © FANUC 2017

# 299

## Program Input

# Macro for Multi-Axes High-Response Function

---

## Features

With the Macro for Multi-Axes High-Response Function, it is possible to use macro statements and custom macro variables in the high-response mode.

## Note

The Multi-Axes High-Response Function is required to use this function

## Benefits

- Extends the application range of the Multi-Axes High-Response Function

## Ordering Information

Specification	Description
A02B-0334-R397	PM i-A Macro for Multi-Axes High-Response Function

### Notice

Certain functions may require additional hardware, different CPU type or additional memory capacity or may cause compatibility issue with other functions. In case of doubt, contact your FANUC sales representative for additional information and support.

The information given in the FANUC manuals or original manufacturer documentation shall prevail. Technical data is subject to change without prior notice. No part of this document may be reproduced in any form. All rights reserved. © FANUC 2017

# 300

## Program Input

# Extended P-Code Variables Size

## Features

This function increases the total number of available P-code variables and extended P-code variables for Macro Executor.

## Benefits

- Increase the processing capabilities of Macro Executor

## Ordering Information

Specification	Description
A02B-0323-J739#1M	30i-B Extended P-Code Variables, 1 MB
A02B-0323-J739#256K	30i-B Extended P-Code Variables, 256 kB
A02B-0323-J739#512K	30i-B Extended P-Code Variables, 512 kB
A02B-0326-J739#1M	31i-B5 Extended P-Code Variables, 1 MB
A02B-0326-J739#256K	31i-B5 Extended P-Code Variables, 256 kB
A02B-0326-J739#512K	31i-B5 Extended P-Code Variables, 512 kB
A02B-0333-J739#1M	35i-B Extended P-Code Variables, 1 MB
A02B-0333-J739#256K	35i-B Extended P-Code Variables, 256 kB
A02B-0333-J739#512K	35i-B Extended P-Code Variables, 512 kB
A02B-0334-J739#1M	PM i-A Extended P-Code Variables, 1 MB
A02B-0334-J739#256K	PM i-A Extended P-Code Variables, 256 kB
A02B-0334-J739#512K	PM i-A Extended P-Code Variables, 512 kB
A02B-0339-J739#256K	0i-TF Extended P-Code Variables Size 256 kB
A02B-0339-J739#512K	0i-TF Extended P-Code Variables Size 512 kB
A02B-0340-J739#256K	0i-MF Extended P-Code Variables Size 256 kB
A02B-0340-J739#512K	0i-MF Extended P-Code Variables Size 512 kB

### Notice

Certain functions may require additional hardware, different CPU type or additional memory capacity or may cause compatibility issue with other functions. In case of doubt, contact your FANUC sales representative for additional information and support.

The information given in the FANUC manuals or original manufacturer documentation shall prevail. Technical data is subject to change without prior notice. No part of this document may be reproduced in any form. All rights reserved. © FANUC 2017

# 301

## Program Input

# Number of Custom Macro Variable Name 1000

## Features

This function increases the maximum number of custom macro variable names. It is possible to set up to 1000 variable names with the SETVN command. Variable names enhance the readability of custom macro programs, they can be set to any custom macro variable including local variables, system variables etc.

## Benefits

- Improve the development and maintenance of custom macro programs

## Ordering Information

Specification	Description
A02B-0323-R323	30i-B Number of Custom Macro Variable Name 1000
A02B-0326-R323	31i-B5 Number of Custom Macro Variable Name 1000
A02B-0327-R323	31i-B Number of Custom Macro Variable Name 1000
A02B-0328-R323	32i-B Number of Custom Macro Variable Name 1000
A02B-0339-R323	0i-TF Number of Custom Macro Variable Name 1000
A02B-0340-R323	0i-MF Number of Custom Macro Variable Name 1000

### Notice

Certain functions may require additional hardware, different CPU type or additional memory capacity or may cause compatibility issue with other functions. In case of doubt, contact your FANUC sales representative for additional information and support.

The information given in the FANUC manuals or original manufacturer documentation shall prevail. Technical data is subject to change without prior notice. No part of this document may be reproduced in any form. All rights reserved. © FANUC 2017

# 302

## Program Input

# Number of Custom Macro Variable Name 4000

## Features

This function increases the maximum number of custom macro variable names. It is possible to set up to 4000 variable names with the SETVN command. Variable names enhance the readability of custom macro programs, they can be set to any custom macro variable including local variables, system variables etc.

## Benefits

- Improve the development and maintenance of custom macro programs

## Ordering Information

Specification	Description
A02B-0323-R324	30i-B Number of Custom Macro Variable Name 4000
A02B-0326-R324	31i-B5 Number of Custom Macro Variable Name 4000
A02B-0327-R324	31i-B Number of Custom Macro Variable Name 4000
A02B-0328-R324	32i-B Number of Custom Macro Variable Name 4000
A02B-0339-R324	0i-TF Number of Custom Macro Variable Name 4000
A02B-0340-R324	0i-MF Number of Custom Macro Variable Name 4000

### Notice

Certain functions may require additional hardware, different CPU type or additional memory capacity or may cause compatibility issue with other functions. In case of doubt, contact your FANUC sales representative for additional information and support.

The information given in the FANUC manuals or original manufacturer documentation shall prevail. Technical data is subject to change without prior notice. No part of this document may be reproduced in any form. All rights reserved. © FANUC 2017

# 303

## Program Input

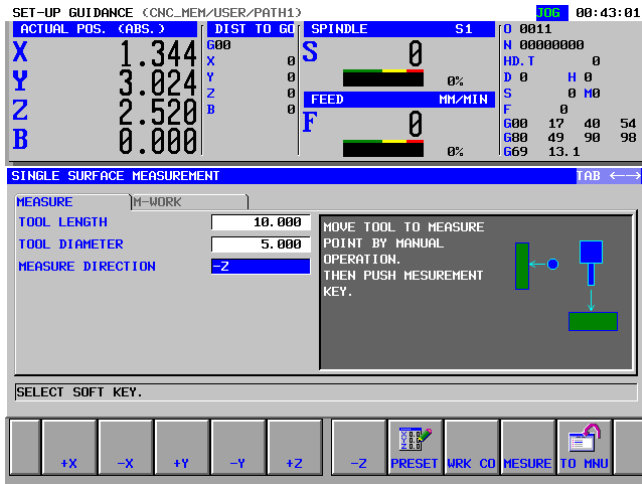

# Set-Up Guidance Function

## Features

With this function, it is possible to measure the position of a workpiece with a usual milling tool or a centering bar, and to set the measured positions to the work coordinate system. A guidance screen leads the operator through the measurement sequence.

It is possible to measure workpiece positions without a measurement probe. The ladder program need not to be adapted to use a measurement probe.

## Benefits

- Simplifies the set-up procedure on basic milling machines

## Ordering Information

Specification	Description
A02B-0340-S771	0i-MF Set-up Guidance Function

### Notice

Certain functions may require additional hardware, different CPU type or additional memory capacity or may cause compatibility issue with other functions. In case of doubt, contact your FANUC sales representative for additional information and support.

The information given in the FANUC manuals or original manufacturer documentation shall prevail. Technical data is subject to change without prior notice. No part of this document may be reproduced in any form. All rights reserved. © FANUC 2017



# 304 Functions

## Integrated Operation & Programming Guidance Functions

FANUC products and solutions reflect over 50 years of experience in machine tools, conversational / interactive programming and part programming on the shop floor. The straightforward design of the operation screens allows fast, simple and user friendly operation.

Without particular knowledge of G-code programming, it is possible to generate part programs, just by answering simple questions.

Enhanced simulation capabilities are also provided to verify the part programs without moving the axes.

Interactive programming solutions detailed in this catalogue:

- MANUAL GUIDE i for Series 30i and Series 0i CNC
- MANUAL GUIDE 0i for Series 0i CNC
- TURN MATE i for Series 0i CNC



### Notice

Certain functions may require additional hardware, different CPU type or additional memory capacity or may cause compatibility issue with other functions. In case of doubt, contact your FANUC sales representative for additional information and support.

The information given in the FANUC manuals or original manufacturer documentation shall prevail. Technical data is subject to change without prior notice. No part of this document may be reproduced in any form. All rights reserved. © FANUC 2017

# 305

## Integrated Operation & Programming Guidance Functions

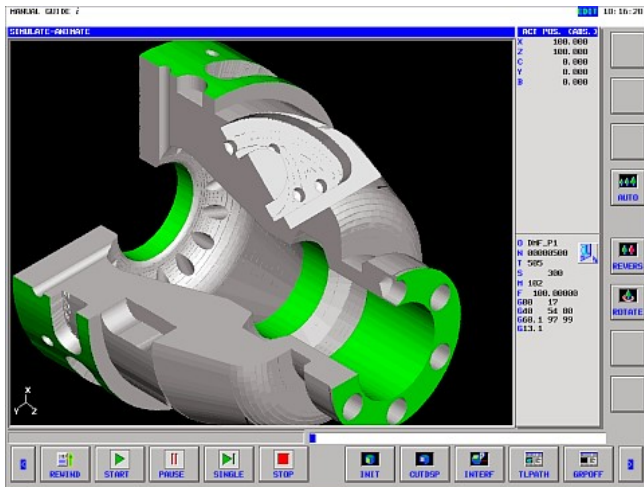

### Notice

Certain functions may require additional hardware, different CPU type or additional memory capacity or may cause compatibility issue with other functions. In case of doubt, contact your FANUC sales representative for additional information and support.

The information given in the FANUC manuals or original manufacturer documentation shall prevail. Technical data is subject to change without prior notice. No part of this document may be reproduced in any form. All rights reserved. © FANUC 2017

# MANUAL GUIDE i Basic Software

## Features

MANUAL GUIDE i is a powerful software for shop floor programming; it provides machine operators with user friendly and powerful capabilities to operate a machine. The innovative programming system enables the development of programs from a drawing to a production part in a very short time.

MANUAL GUIDE i supports turning, milling and compound machining applications and can be used on simple machine as well as on very advanced machining processes.

The MANUAL GUIDE i software is built around the standard CNC ISO code format of the CNC and adds an ergonomic user interface to program the cycles. It uses a Graphical User Interface (GUI) with user-friendly icons which allows the user to interactively create part programs in just a few steps. All of the relevant information is displayed on a single CNC screen. Having to constantly change between screens is thus avoided as is the risk of getting lost in the numerous pop-up screens.

Key features of MANUAL GUIDE i:

- Operator friendly programming environment
- Advanced cycle machining (Turning and Milling)
- Measurement cycles for workpieces and tools
- Detailed part program 3D simulation
- CNC ISO conversion of machining cycles
- Powerful editor and profile calculation
- Seamless environment switching
- Support for multi path Lathes and Milling machines
- Residual cutting
- Background machining simulation
- File management
- Customizable to add guidance windows for customer machining cycles

Several additional functions are available for MANUAL GUIDE i, such as Multi Path support, Tilted Working Plane support for 5-axis machining, etc. These functions are described further in the catalogue.

MANUAL GUIDE i can also be simulated on a Personal Computer with NCGuide or NCGuidePro. Refer to the software section of the catalogue for further information on this subject.

## Benefits

- Assisted and conversational programming of machining cycles
- Simplification of the programming of parts
- Reduction of the total time required from drawing to cutting
- Simulation of the part program before cutting metal and machining

- Improvement of the overall machining productivity

## Ordering Information

Specification	Description
A02B-0323-R948	30i-B MANUAL GUIDE i - MG-i Enhanced (incl. All-in-One Screen, Advanced Editor, a. o.)
A02B-0323-R949	30i-B MANUAL GUIDE i - Upgrade to MG-i Enhanced (incl. All-in-One Screen, Advanced Editor, a. o.)
A02B-0326-R948	31i-B5 MANUAL GUIDE i - MG-i Enhanced (incl. All-in-One Screen, Advanced Editor, a. o.)
A02B-0326-R949	31i-B5 MANUAL GUIDE i - Upgrade to MG-i Enhanced (incl. All-in-One Screen, Advanced Editor, a. o.)
A02B-0327-R948	31i-B MANUAL GUIDE i - MG-i Enhanced (incl. All-in-One Screen, Advanced Editor, a. o.)
A02B-0327-R949	31i-B MANUAL GUIDE i - Upgrade to MG-i Enhanced (incl. All-in-One Screen, Advanced Editor, a. o.)
A02B-0328-R948	32i-B MANUAL GUIDE i - MG-i Enhanced (incl. All-in-One Screen, Advanced Editor, a. o.)
A02B-0328-R949	32i-B MANUAL GUIDE i - Upgrade to MG-i Enhanced (incl. All-in-One Screen, Advanced Editor, a. o.)
A02B-0339-S790	0i-TF MANUAL GUIDE i (MG i)
A02B-0340-S790	0i-MF MANUAL GUIDE i (MG i)

### Notice

Certain functions may require additional hardware, different CPU type or additional memory capacity or may cause compatibility issue with other functions. In case of doubt, contact your FANUC sales representative for additional information and support.

The information given in the FANUC manuals or original manufacturer documentation shall prevail. Technical data is subject to change without prior notice. No part of this document may be reproduced in any form. All rights reserved. © FANUC 2017

# 307

## Integrated Operation & Programming Guidance Functions

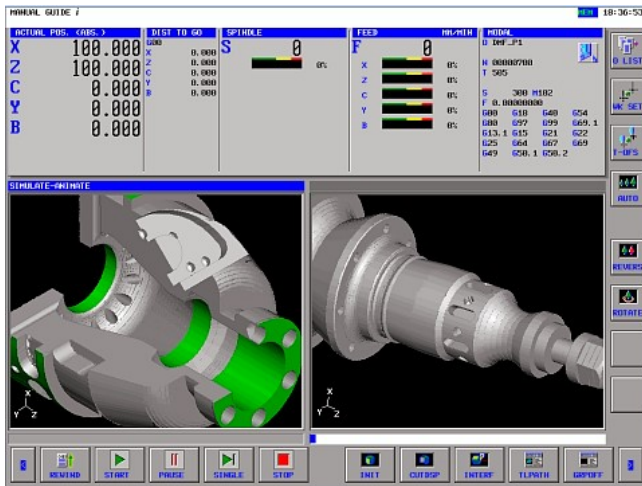

# MANUAL GUIDE i Multi-Path Support

## Features

The Multi-Path Support function extends the MANUAL GUIDE i functionalities to multi paths machines. It provides the capability to program machining cycles and execute them in several paths.

Supported machine configurations:

- Lathes machines: 2, 3 and 4 paths
- Milling machines: 2 paths

## Benefits

- Increase of the capability of MANUAL GUIDE i to support multi-path configurations
- Increase of the productivity of multi path lathes and multi path milling machines

## Ordering Information

Specification	Description
A02B-0323-S786	30i-B MANUAL GUIDE i - Multi-Path Lathe
A02B-0326-S786	31i-B5 MANUAL GUIDE i - Multi-Path Lathe
A02B-0327-S786	31i-B MANUAL GUIDE i - Multi-Path Lathe
A02B-0328-S786	32i-B MANUAL GUIDE i - Multi-Path Lathe
A02B-0339-S786	0i-TF MANUAL GUIDE i - Multi-Path Function
A02B-0340-S786	0i-MF MANUAL GUIDE i - Multi-Path Function

### Notice

Certain functions may require additional hardware, different CPU type or additional memory capacity or may cause compatibility issue with other functions. In case of doubt, contact your FANUC sales representative for additional information and support.

The information given in the FANUC manuals or original manufacturer documentation shall prevail. Technical data is subject to change without prior notice. No part of this document may be reproduced in any form. All rights reserved. © FANUC 2017

# 308

## Integrated Operation & Programming Guidance Functions

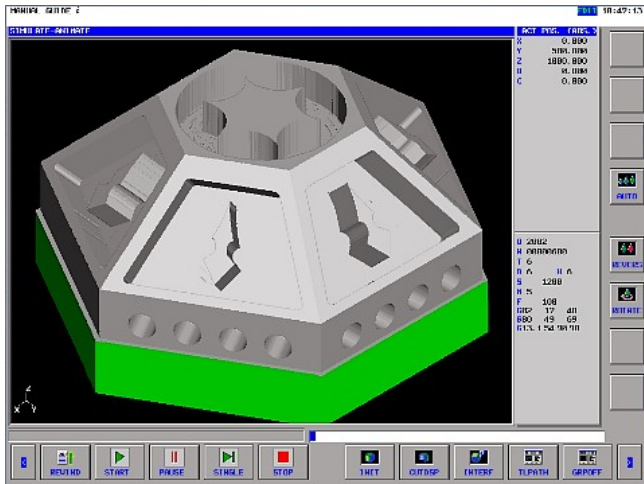

### Notice

Certain functions may require additional hardware, different CPU type or additional memory capacity or may cause compatibility issue with other functions. In case of doubt, contact your FANUC sales representative for additional information and support.

The information given in the FANUC manuals or original manufacturer documentation shall prevail. Technical data is subject to change without prior notice. No part of this document may be reproduced in any form. All rights reserved. © FANUC 2017

# MANUAL GUIDE i Tilted Working Plane (TWP) Machining Function

## Features

The Tilted Working Plane (TWP) Machining function for MANUAL GUIDE i provides a set of guidance windows to program Tilted Working Plane machining comfortably.

The following Tilted Working Plane machining cycles are available in MANUAL GUIDE i:

- Euler's angle
- Roll-Pitch-Yaw angle
- 3 points specification
- 2 vectors specification
- Projection angle
- Tool axis direction
- Tilted Working Plane cancel

Limitation in machining simulation:

- The machining simulation is only provided for mechanical unit or mechanical configurations which are of "table rotation type", that the "A" is the rotary master axis and the "C" is the rotary slave axis. In all other rotary axis configurations machining simulation cannot be performed.
- In case of incremental Tilted Working Plane command or simulation of Tilted Working Plane with simultaneous rotation of two axes, the machining simulation cannot be performed.
- Machining simulation by single block soft key cannot be simulated.

## Benefits

- Guidance windows to program Tilted Planes commands in different formats
- The operator can choose which cycle is best suited depending from how the tilted plane is specified in the part drawing

## Ordering Information

Specification	Description
A02B-0323-S788	30i-B MANUAL GUIDE i - Tilted Working Plane Machining Function
A02B-0326-S788	31i-B5 MANUAL GUIDE i - Tilted Working Plane Machining Function
A02B-0327-S788	31i-B MANUAL GUIDE i - Tilted Working Plane Machining Function
A02B-0328-S788	32i-B MANUAL GUIDE i - Tilted Working Plane Machining Function

# 309

Specification	Description
A02B-0340-S788	0i-MF MANUAL GUIDE i - Tilted Work Plane Index

**Notice**

Certain functions may require additional hardware, different CPU type or additional memory capacity or may cause compatibility issue with other functions. In case of doubt, contact your FANUC sales representative for additional information and support.

The information given in the FANUC manuals or original manufacturer documentation shall prevail. Technical data is subject to change without prior notice. No part of this document may be reproduced in any form. All rights reserved. © FANUC 2017

# 310

## Integrated Operation & Programming Guidance Functions

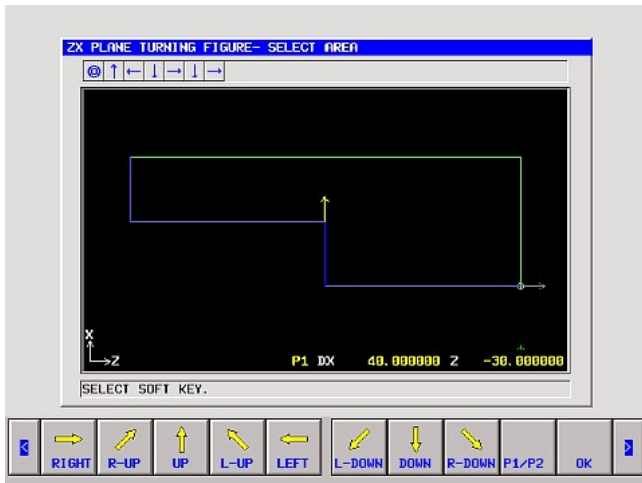

### Notice

Certain functions may require additional hardware, different CPU type or additional memory capacity or may cause compatibility issue with other functions. In case of doubt, contact your FANUC sales representative for additional information and support.

The information given in the FANUC manuals or original manufacturer documentation shall prevail. Technical data is subject to change without prior notice. No part of this document may be reproduced in any form. All rights reserved. © FANUC 2017

# MANUAL GUIDE i Windows Call Function

## Features

The Windows Call function provides the capability to call and display MANUAL GUIDE i windows within a C Language Executor application :

- Blank figure selection window
- Blank figure data input window (fixed form and arbitrary free figure)
- Free figure input window (free figure creation window and range selection window)
- Machining simulation window
- NC program conversion window

## Benefits

- Possibility to customize and enhance MANUAL GUIDE i with screens and features.

## Ordering Information

Specification	Description
A02B-0323-S779	30i-B MANUAL GUIDE i - Windows Call Function
A02B-0326-S779	31i-B5 MANUAL GUIDE i - Windows Call Function
A02B-0327-S779	31i-B MANUAL GUIDE i - Windows Call Function
A02B-0328-S779	32i-B MANUAL GUIDE i - Windows Call Function
A02B-0339-S779	0i-TF MANUAL GUIDE i - Window Call Function
A02B-0340-S779	0i-MF MANUAL GUIDE i - Window Call Function

# 311

## Integrated Operation & Programming Guidance Functions

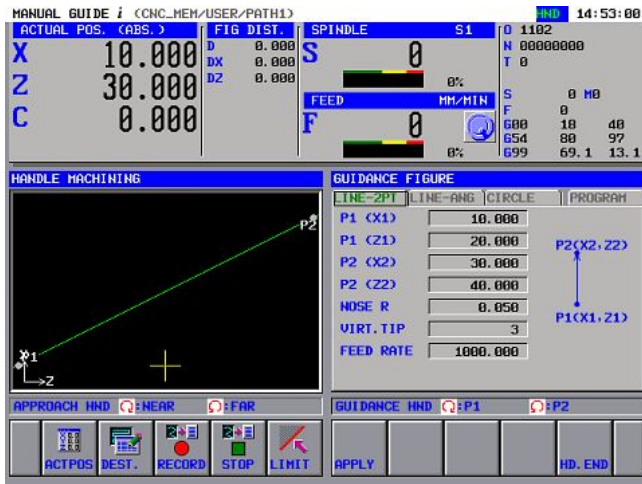

# MANUAL GUIDE i Handle Machining Function

## Features

The Handle Machining function provides the following two features to MANUAL GUIDE i:

- Machining by handle: this feature enables the operators to machine a slanted line or an arc with simultaneous two axes motion using a single handle.
- Programming by handle: the handle operation can be memorized as a program and the tool motion can be played back.

## Benefits

- Simplification of the approach and programming process
- Decrease of the time required to setup the work
- Overall increase of the productivity of the machine

## Ordering Information

Specification	Description
A02B-0323-S797	30i-B Handle Machining Function
A02B-0326-S797	31i-B5 Handle Machining Function
A02B-0327-S797	31i-B Handle Machining Function
A02B-0328-S797	32i-B Handle Machining Function
A02B-0339-S797	0i-TF Handle Machining Function
A02B-0340-S797	0i-MF Handle Machining Function

### Notice

Certain functions may require additional hardware, different CPU type or additional memory capacity or may cause compatibility issue with other functions. In case of doubt, contact your FANUC sales representative for additional information and support.

The information given in the FANUC manuals or original manufacturer documentation shall prevail. Technical data is subject to change without prior notice. No part of this document may be reproduced in any form. All rights reserved. © FANUC 2017



# 312

## Integrated Operation & Programming Guidance Functions

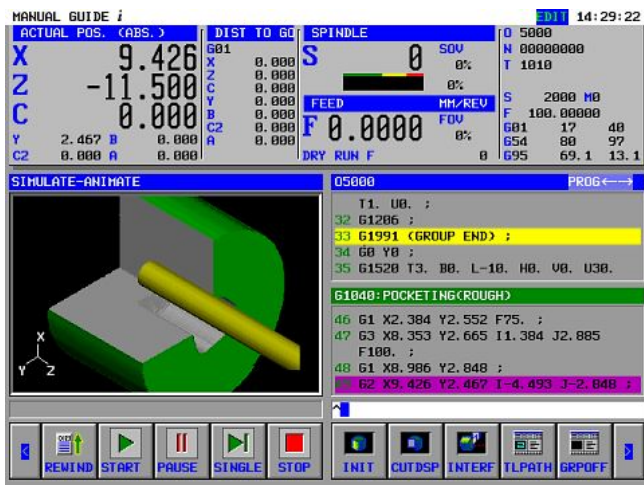

# MANUAL GUIDE i Advanced Guidance Function

## Features

The MANUAL GUIDE i Advanced Guidance Option provides the following features:

- Decomposed cycle display: this function can display the part program blocks being generated by the MANUAL GUIDE i cycles during machining simulation on the machining simulation screen.
- Input data check by simulation: the operation of a cycle that is being edited can be checked by the machining simulation function (animation / tool pathdrawing ) at the same time.
- Help window for each screen (PANEL i required): a context sensitive help of the MANUAL GUIDE i cycle currently being edited is displayed by pushing the HELP key on the MDI keyboard.
- Integration of animation software that is running on PANEL i: MANUAL GUIDE i can be interfaced to 3rd party simulation software running on PC; these packages can be used when high performance simulations are required. The 3rd party animation software can access the storage memory of the CNC and can acquire the machining program (MANUAL GUIDE i does not output the machining program to 3rd party animation software directly).

## Benefits

- Extension of the function set of MANUAL GUIDE i
- Simplification of the programming
- Improvement of the overall machining productivity

## Ordering Information

Specification	Description
A02B-0323-S774	30i-B MANUAL GUIDE i - Advanced Guidance Function
A02B-0326-S774	31i-B5 MANUAL GUIDE i - Advanced Guidance Function
A02B-0327-S774	31i-B MANUAL GUIDE i - Advanced Guidance Function
A02B-0328-S774	32i-B MANUAL GUIDE i - Advanced Guidance Function
A02B-0339-S774	0i-TF MANUAL GUIDE i - Advanced Guidance Function
A02B-0340-S774	0i-MF MANUAL GUIDE i - Advanced Guidance Function

### Notice

Certain functions may require additional hardware, different CPU type or additional memory capacity or may cause compatibility issue with other functions. In case of doubt, contact your FANUC sales representative for additional information and support.

The information given in the FANUC manuals or original manufacturer documentation shall prevail. Technical data is subject to change without prior notice. No part of this document may be reproduced in any form. All rights reserved. © FANUC 2017

# 313

## Integrated Operation & Programming Guidance Functions

ACTUAL POS. (ABS.)		DIST TO GO	
X	300.000	G00	
Z	73.740	X	0.000
C <sub>1</sub>	30.000	Z	0.000
Y	0.000	C1	0.000
B	0.000	Y	0.000
C <sub>2</sub>	0.000	B	0.000
		C2	0.000
NEXT DIST			
		G00	
		X	0.000
		Z	0.000
		C1	0.000
		Y	0.000
		B	0.000
		C2	0.000

### Notice

Certain functions may require additional hardware, different CPU type or additional memory capacity or may cause compatibility issue with other functions. In case of doubt, contact your FANUC sales representative for additional information and support.

The information given in the FANUC manuals or original manufacturer documentation shall prevail. Technical data is subject to change without prior notice. No part of this document may be reproduced in any form. All rights reserved. © FANUC 2017

# MANUAL GUIDE i Extended Axis Name Function

## Features

With the Extended Axis Name function, it is possible to add extended axis names to MANUAL GUIDE i machining cycles .

Extended axis name can be used with linear axis other than the basic three axis or rotary axis of workpiece rotation and are composed of 2 characters that are a letter and a number; for example B2, C2, etc.

Extended axis name can also be displayed on the following screens:

- Base screen
- Relative coordinates presetting screen
- Workpiece coordinate data screen
- Machining simulation screen

This function can be used on following screens / resolutions:

- 19" and 15" LCD screens on the Series 30i / 31i / 32i - MODEL A and MODEL B CNC
- 8.4" and 10.4" LCD screens on the Series 30i / 31i / 32i MODEL B CNC

## Benefits

- The advantage of the MANUAL GUIDE i machining cycles can also used on machines tools using extended axis names

## Ordering Information

Specification	Description
A02B-0323-S789	30i-B MANUAL GUIDE i - Extended Axis Name Function - 2 Characters for Axis Name on MANUAL GUIDE i Screen
A02B-0326-S789	31i-B5 MANUAL GUIDE i - Extended Axis Name Function - 2 Characters for Axis Name on MANUAL GUIDE i Screen
A02B-0327-S789	31i-B MANUAL GUIDE i - Extended Axis Name Function - 2 Characters for Axis Name on MANUAL GUIDE i Screen
A02B-0328-S789	32i-B MANUAL GUIDE i - Extended Axis Name Function - 2 Characters for Axis Name on MANUAL GUIDE i Screen
A02B-0339-S789	0i-TF MANUAL GUIDE i - Extended Axis Name Function
A02B-0340-S789	0i-MF MANUAL GUIDE i - Extended Axis Name Function

# 314

## Integrated Operation & Programming Guidance Functions

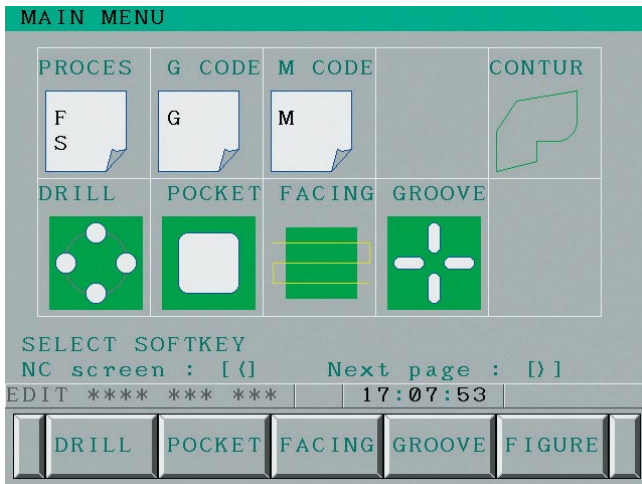

### Notice

Certain functions may require additional hardware, different CPU type or additional memory capacity or may cause compatibility issue with other functions. In case of doubt, contact your FANUC sales representative for additional information and support.

The information given in the FANUC manuals or original manufacturer documentation shall prevail. Technical data is subject to change without prior notice. No part of this document may be reproduced in any form. All rights reserved. © FANUC 2017

## MANUAL GUIDE 0i

### Features

MANUAL GUIDE 0i is a simplified operation guidance software to assist an operator in creating complex part program, and actual machining.

MANUAL GUIDE 0i provides the following features:

- ISO code part programming: ISO can be used to directly input a simple operation such as linear or arc machining with G codes or easily input complicated operations such as pocketing or turning within an existing machining cycle
- Easy specification of a tool, spindle, coolant and feedrate: these conditions can easily be specified on a screen before machining
- Easy programming of G codes and M codes: G codes and M codes can easily be input with reference to the screen for G code description and illustration and the screen for M code description and illustration.
- Preparation of machining cycles for machining centers:
  - Hole machining (pattern figure)
  - Pocketing (pattern figure)
  - Facing (pattern figure)
  - Grooving (pattern figure)
- Preparation of machining cycles for lathe systems:
  - Drilling (workpiece center)
  - Turning (arbitrary figure)
  - Grooving (normal groove, trapezoidal groove)
  - Threading (general-purpose thread, metric thread, unified thread, PT/PF thread)
- Easy input of contour figure: a contour figure consisting of lines and arcs can be easily input and converted into a NC command block (G01/G02/G03). In addition, advance figure calculation functions can be performed with the help of 11 auxiliary functions.

Available language packages for MANUAL GUIDE 0i:

- English, Chinese, Japanese
- English, German, French
- English, Italian, Spanish
- English, Swedish, Portuguese
- English, Czech, Polish

### Benefits

- Assisted and conversational programming of machining cycles
- Simplification of the programming of parts
- Reduction of the total time required from parts drawing to parts cutting
- Improvement of the overall machining productivity

# 315

## Ordering Information

Specification	Description
A02B-0339-S772	0i-TF MANUAL GUIDE 0i
A02B-0340-S772	0i-MF MANUAL GUIDE 0i

### Notice

Certain functions may require additional hardware, different CPU type or additional memory capacity or may cause compatibility issue with other functions. In case of doubt, contact your FANUC sales representative for additional information and support.

The information given in the FANUC manuals or original manufacturer documentation shall prevail. Technical data is subject to change without prior notice. No part of this document may be reproduced in any form. All rights reserved. © FANUC 2017

# 316

## Integrated Operation & Programming Guidance Functions

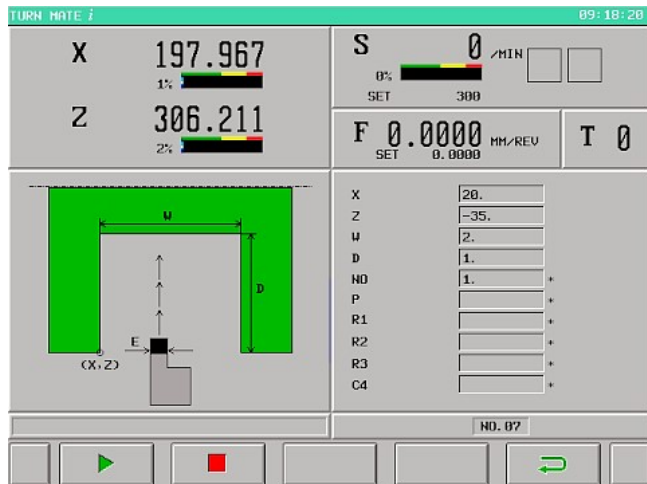

### Notice

Certain functions may require additional hardware, different CPU type or additional memory capacity or may cause compatibility issue with other functions. In case of doubt, contact your FANUC sales representative for additional information and support.

The information given in the FANUC manuals or original manufacturer documentation shall prevail. Technical data is subject to change without prior notice. No part of this document may be reproduced in any form. All rights reserved. © FANUC 2017

# TURN MATE i Basic Software

## Features

TURN MATE i is a conversational software function which can assist the operation of entry-level turning machines. The productivity and the flexibility of turning machines can be greatly increased through the operator assistance functions provided by TURN MATE i, which can substitute to the know-how in CNC machining.

No knowledge of G code ISO language is required to program workpieces with TURN MATE i.

TURN MATE i is easy to operate with clearly laid out screens; it is available for monochrome or color displays, for touch screens or traditional keyboard / MDI operation.

Various semi-automatic cycles and linked cycles are provided and with the NC conversion function it is possible to convert machining cycles in standard NC ISO language (Optional Function).

Overview of the product features:

- Manual operation with programmable traversing limits
- Tool geometry compensation for up to 16 tools
- Constant surface speed
- Program execution in accordance with DIN/ ISO
- Imperial (inches) or metric display
- Choice of language
- Calculator function
- Cutting cycles
  - Outer roughing
  - Inner roughing (including dressing)
  - Rear face machining
  - Taper turning
  - Thread cutting
  - Tapping
  - Cutting of tapered threads
  - Thread repair
  - Recess Cutting
  - Ball turning
  - Grooving
  - Contour turning based on individual points (free figures)
  - Non-monotonous free figures
- Linked cutting cycles
- Memory Card interface
- NC ISO conversion
- Assisted and conversational programming of machining cycles

# 317

- Simplification of the programming of parts
- Reduction of the total time required from parts drawing to parts cutting
- Improvement of the overall machining productivity

## Ordering Information

Specification	Description
A02B-0339-S792	0i-TF TURN MATE i - with Touch Panel
A02B-0339-S793	0i-TF TURN MATE i - without Touch Panel

### Notice

Certain functions may require additional hardware, different CPU type or additional memory capacity or may cause compatibility issue with other functions. In case of doubt, contact your FANUC sales representative for additional information and support.

The information given in the FANUC manuals or original manufacturer documentation shall prevail. Technical data is subject to change without prior notice. No part of this document may be reproduced in any form. All rights reserved. © FANUC 2017

# 318

## Integrated Operation & Programming Guidance Functions

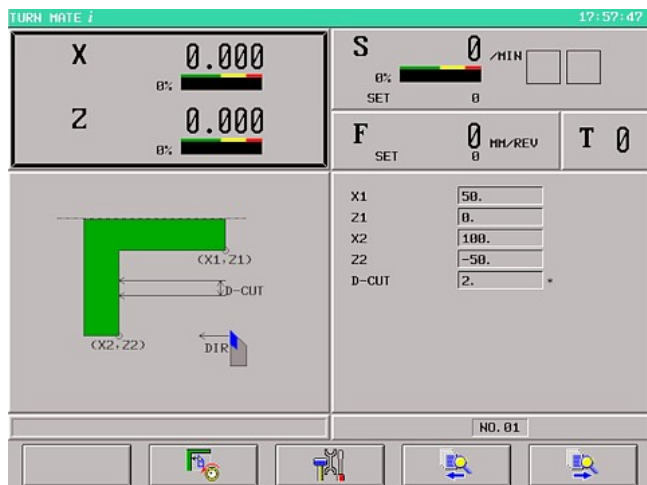

## TURN MATE i MDI Key Operation Function

### Features

TURN MATE i has been originally designed to work on CNC equipped with touch panel displays. With this function, it is also possible to operate TURN MATE i on non-touch panel displays equipped with a MDI keyboard.

A cursor on the screen will indicate the object being focused on. The cursor can be moved on the screen using the cursor keys of the MDI keyboard.

### Benefits

- Possibility to use TURN MATE i on machine not equipped with touch panel displays

### Ordering Information

Specification	Description
A02B-0339-S794	0i-TF TURN MATE i - MDI Key Operation Function

### Notice

Certain functions may require additional hardware, different CPU type or additional memory capacity or may cause compatibility issue with other functions. In case of doubt, contact your FANUC sales representative for additional information and support.

The information given in the FANUC manuals or original manufacturer documentation shall prevail. Technical data is subject to change without prior notice. No part of this document may be reproduced in any form. All rights reserved. © FANUC 2017

# 319

## Integrated Operation & Programming Guidance Functions

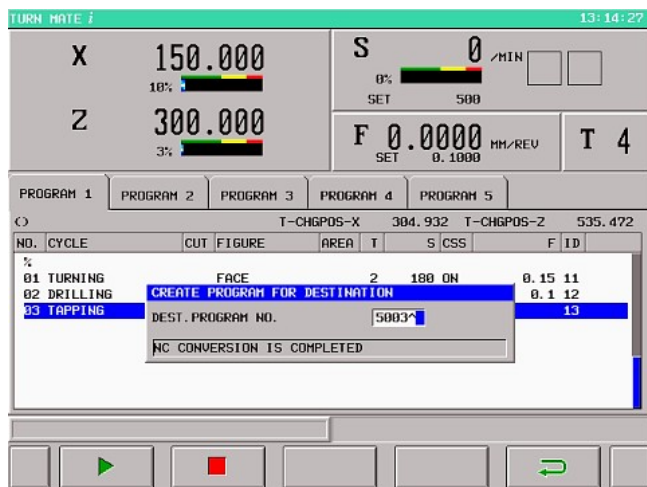

# TURN MATE i NC Program Conversion Function

## Features

TURN MATE i machining cycles can be converted into standard ISO G code blocks with the NC Program Conversion function.

The part program generated by this function can be used on other machines which do not feature TURN MATE i. In addition, the operator can perform a detailed analysis of the movements generated by the machining cycles.

## Benefits

- The same workpiece machined with TURN MATE i can also be machined on CNC machines where TURN MATE i is not available.

## Ordering Information

Specification	Description
A02B-0339-S795	0i-TF TURN MATE i - NC Program Conversion Function

### Notice

Certain functions may require additional hardware, different CPU type or additional memory capacity or may cause compatibility issue with other functions. In case of doubt, contact your FANUC sales representative for additional information and support.

The information given in the FANUC manuals or original manufacturer documentation shall prevail. Technical data is subject to change without prior notice. No part of this document may be reproduced in any form. All rights reserved. © FANUC 2017



# 320

## Integrated Operation & Programming Guidance Functions

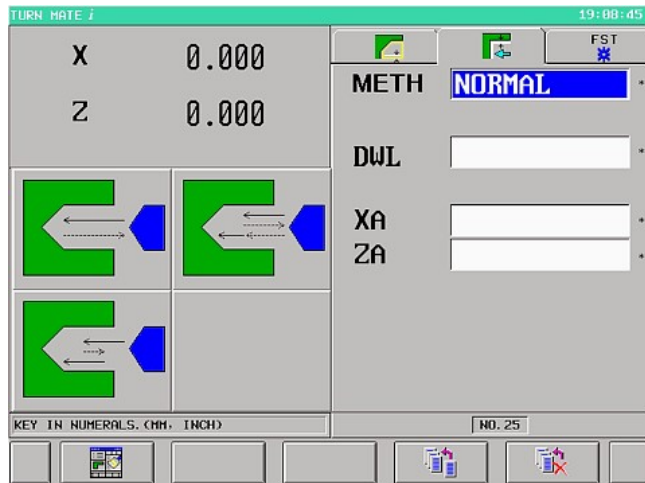

# TURN MATE i Expansion of Machining Cycles

## Features

The TURN MATE i Expansion of Machining Cycle function features the following key items:

- Detailed information such as cutting method, etc. is displayed on the base screen
- The 3 types of drilling cycles (Normal / Peck / High-speed Peck) can be selected on the input data screen
- Possibility to input the negative X values in facing cycles

## Benefits

- Extension of the function set of TURN MATE i
- Simplification of the programming
- Improvement of the overall machining productivity

## Ordering Information

Specification	Description
A02B-0339-S796	0i-TF TURN MATE i - Expansion of Machining Cycle

### Notice

Certain functions may require additional hardware, different CPU type or additional memory capacity or may cause compatibility issue with other functions. In case of doubt, contact your FANUC sales representative for additional information and support.

The information given in the FANUC manuals or original manufacturer documentation shall prevail. Technical data is subject to change without prior notice. No part of this document may be reproduced in any form. All rights reserved. © FANUC 2017

# 321

## Integrated Operation & Programming Guidance Functions

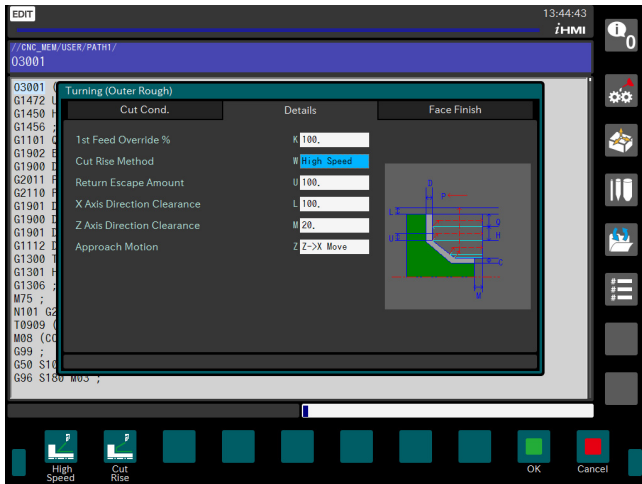

### Notice

Certain functions may require additional hardware, different CPU type or additional memory capacity or may cause compatibility issue with other functions. In case of doubt, contact your FANUC sales representative for additional information and support.

The information given in the FANUC manuals or original manufacturer documentation shall prevail. Technical data is subject to change without prior notice. No part of this document may be reproduced in any form. All rights reserved. © FANUC 2017

## iHMI Machining Cycle

### Features

iHMI Machining Cycle is a user interface for the execution of machining cycles. It is an extension for the FANUC iHMI operation interface. More than 200 cycles for milling and turning are included in this function. Graphical guidance screens assist the user in selecting the proper cycle and inputting the cycle parameter data. Part shapes can be input graphically and can be saved for re-use. Up to 4 paths are supported by the function.

Panel iH / iH Pro is necessary to use the function.

### Benefits

- Execute complex machining operations easily by simply selecting and parametrizing machining cycles
- Reduce the time from drawing to cutting

### Ordering Information

Specification	Description
A02B-0323-R911	30i-B iHMI Machining Cycle (for 1-Path System)
A02B-0323-R912	30i-B iHMI Machining Cycle (for 2-Path System)
A02B-0323-R913	30i-B iHMI Machining Cycle (for 3-Path System)
A02B-0323-R914	30i-B iHMI Machining Cycle (for 4-Path System)

# 322

## Integrated Operation & Programming Guidance Functions

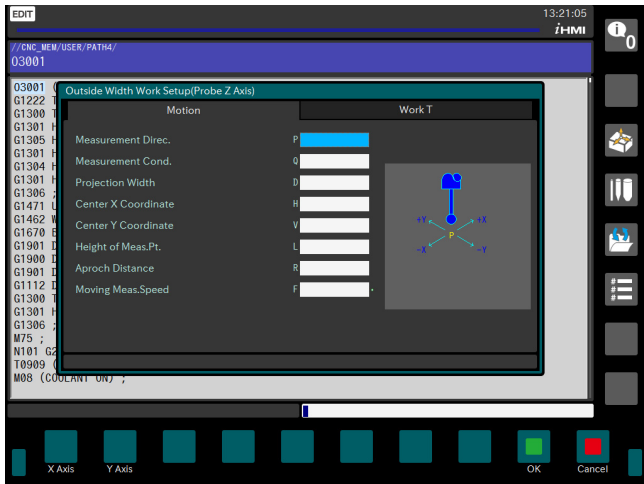

### Notice

Certain functions may require additional hardware, different CPU type or additional memory capacity or may cause compatibility issue with other functions. In case of doubt, contact your FANUC sales representative for additional information and support.

The information given in the FANUC manuals or original manufacturer documentation shall prevail. Technical data is subject to change without prior notice. No part of this document may be reproduced in any form. All rights reserved. © FANUC 2017

## iHMI Set-Up Guidance

### Features

iHMI Set-Up Guidance is a user interface for the execution of measurement cycles. It is an extension for the FANUC iHMI operation interface. More than 100 cycles for tool measurement, workpiece set-up, post-machining inspection and calibration are included in this function. Graphical guidance screens assist the user in selecting the proper cycle and inputting the cycle parameter data.

Panel iH / iH Pro is necessary to use the function.

### Benefits

- Execute complex measurement operations easily by simply selecting and parametrizing machining cycles
- Increase the accuracy of machined parts
- Reduce the time from drawing to cutting

### Ordering Information

Specification	Description
A02B-0323-R910	30i-B iHMI Set-up Guidance
A02B-0326-R910	31i-B5 iHMI Set-up Guidance
A02B-0327-R910	31i-B iHMI Set-up Guidance
A02B-0328-R910	32i-B iHMI Set-up Guidance

# 323

## Integrated Operation & Programming Guidance Functions

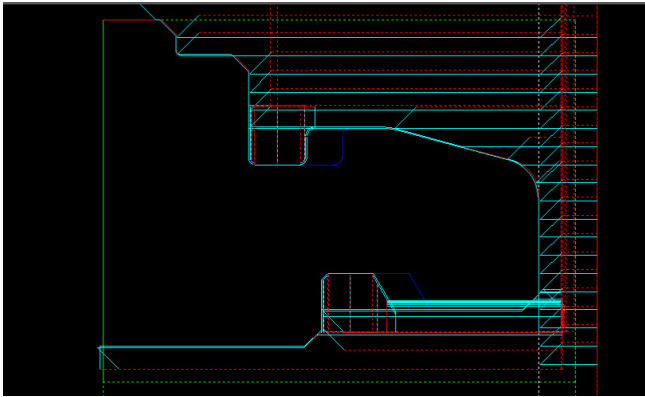

# iHMI Conversational Programming for Complex Lathe

## Features

iHMI Conversational Programming for Complex Lathe is a conversational programming tool for lathes. It is an extension for the FANUC iHMI operation interface. This function allows you to create NC programs by just inputting blanks and part shapes and by selecting machining processes.

Generally, creating part programs requires programming knowledge of G AND M codes. With this function, part programs can be created automatically without any programming knowledge.

The basic function can create part programs for X-Z axes (turning) and C-Y axes (milling). Two-spindle machining is also supported. CAD data can be read in by the function.

The 2-Path function extension allows to create part programs for controlling a second path. Milling machining with Tilted Working Plane by B axis is supported by the B-Axis function extension. Both extensions require the basic function.

Panel iH Pro is necessary to use the function. Only 15" or 19" displays with touch panel are supported.

## Benefits

- Create part programs for complex lathes easily without any programming knowledge
- Reduce the time from drawing to cutting

## Ordering Information

Specification	Description
A02B-0323-R940	30i-B Basic Function of Conversational Programming for Complex Lathe for iHMI
A02B-0323-R941	30i-B B-Axis Function of Conversational Programming for Complex Lathe for iHMI
A02B-0323-R942	30i-B 2-Path Function of Conversational Programming for Complex Lathe for iHMI
A02B-0326-R940	31i-B5 Basic Function of Conversational Programming for Complex Lathe for iHMI
A02B-0326-R941	31i-B5 B-Axis Function of Conversational Programming for Complex Lathe for iHMI
A02B-0326-R942	31i-B5 2-Path Function of Conversational Programming for Complex Lathe for iHMI
A02B-0327-R940	31i-B Basic Function of Conversational Programming for Complex Lathe for iHMI
A02B-0327-R941	31i-B B-Axis Function of Conversational Programming for Complex Lathe for iHMI
A02B-0327-R942	31i-B 2-Path Function of Conversational Programming for Complex Lathe for iHMI
A02B-0328-R940	32i-B Basic Function of Conversational Programming for Complex Lathe for iHMI
A02B-0328-R941	32i-B B-Axis Function of Conversational Programming for Complex Lathe for iHMI
A02B-0328-R942	32i-B 2-Path Function of Conversational Programming for Complex Lathe for iHMI

### Notice

Certain functions may require additional hardware, different CPU type or additional memory capacity or may cause compatibility issue with other functions. In case of doubt, contact your FANUC sales representative for additional information and support.

The information given in the FANUC manuals or original manufacturer documentation shall prevail. Technical data is subject to change without prior notice. No part of this document may be reproduced in any form. All rights reserved. © FANUC 2017

# 324

## Functions

## Auxiliary / Spindle Speed Functions

---

This section of the catalogue contains the functions related to auxiliary and spindle functions in the CNC.

Some of the functions detailed in the catalogue:

- Analogue spindle control
- Spindle orientation
- Spindle synchronous control
- Multi-spindlecontrol
- Spindle CS contour control
- High precision learning control
- Etc.

### Notice

Certain functions may require additional hardware, different CPU type or additional memory capacity or may cause compatibility issue with other functions. In case of doubt, contact your FANUC sales representative for additional information and support.

The information given in the FANUC manuals or original manufacturer documentation shall prevail. Technical data is subject to change without prior notice. No part of this document may be reproduced in any form. All rights reserved. © FANUC 2017

# 325

## Auxiliary / Spindle Speed Functions

## 2nd Auxilliary Function

---

### Features

The 2nd Auxiliary Function provides a second part programming code called "code B" to activate Auxiliary functions.

Up to eight digits, selectable by a parameter setting and a strobe signal are sent to the PMC. Only one B code is allowed per block.

This function is a basic function in FANUC Series 0i-F.

### Benefits

- Allows programming of B code to do M code functions
- Sometime B codes provide ease of use for operation and programming
- Typical application Turn on coolant command  
Pallet 1=M08, Pallet 2=B08
- No change in cycle time

### Ordering Information

Specification	Description
A02B-0323-J920	30i-B 2nd Auxiliary Function
A02B-0326-J920	31i-B5 2nd Auxiliary Function
A02B-0327-J920	31i-B 2nd Auxiliary Function
A02B-0328-J920	32i-B 2nd Auxiliary Function
A02B-0333-J920	35i-B 2nd Auxiliary Function

#### Notice

Certain functions may require additional hardware, different CPU type or additional memory capacity or may cause compatibility issue with other functions. In case of doubt, contact your FANUC sales representative for additional information and support.

The information given in the FANUC manuals or original manufacturer documentation shall prevail. Technical data is subject to change without prior notice. No part of this document may be reproduced in any form. All rights reserved. © FANUC 2017

# 326

## Auxiliary / Spindle Speed Functions

# Auxiliary Function Output in Moving Axis

## Features

The Auxiliary Function Output in Moving Axis provides a way when specifying absolute coordinate values and auxiliary function (M, B) at the G50.9 block, that auxiliary functions are output to PMC when the absolute coordinate enters the specified area in movement block. G50.9 can be specified in 2 blocks continuously.

In other words, the auxiliary function output point in the movement block can be specified in two. Code signals and strobe signals are output to the same signal address as usual auxiliary function.

## Benefits

- Simplification of the programming

## Ordering Information

Specification	Description
A02B-0323-S889	30i-B Auxilliary Function Output in Moving Axis
A02B-0326-S889	31i-B5 Auxilliary Function Output in Moving Axis
A02B-0327-S889	31i-B Auxilliary Function Output in Moving Axis
A02B-0328-S889	32i-B Auxilliary Function Output in Moving Axis
A02B-0339-S889	0i-TF Auxiliary Function Output in Moving Axis
A02B-0340-S889	0i-MF Auxiliary Function Output in Moving Axis

### Notice

Certain functions may require additional hardware, different CPU type or additional memory capacity or may cause compatibility issue with other functions. In case of doubt, contact your FANUC sales representative for additional information and support.

The information given in the FANUC manuals or original manufacturer documentation shall prevail. Technical data is subject to change without prior notice. No part of this document may be reproduced in any form. All rights reserved. © FANUC 2017

# 327

## Auxiliary / Spindle Speed Functions

# Waiting Function by Specifying Start Point

## Features

Control based on M codes is normally used to make one path to wait on the other during machining. When a M code for waiting is specified in a block of a path during automatic operation, the other path waits for the same M code to be specified before starting the execution of the next block.

With the Waiting Function by Specifying Start Point function, by specifying a start point with a waiting M code, the absolute coordinate value of that path or the other path can be used as the condition for waiting.

## Benefits

- Simplification of the programming

## Ordering Information

Specification	Description
A02B-0323-S888	30i-B Waiting Function by Specifying Start Point
A02B-0326-S888	31i-B5 Waiting Function by Specifying Start Point
A02B-0327-S888	31i-B Waiting Function by Specifying Start Point
A02B-0328-S888	32i-B Waiting Function by Specifying Start Point
A02B-0339-S888	0i-TF Waiting Function by Specifying Start Point
A02B-0340-S888	0i-MF Waiting Function by Specifying Start Point

### Notice

Certain functions may require additional hardware, different CPU type or additional memory capacity or may cause compatibility issue with other functions. In case of doubt, contact your FANUC sales representative for additional information and support.

The information given in the FANUC manuals or original manufacturer documentation shall prevail. Technical data is subject to change without prior notice. No part of this document may be reproduced in any form. All rights reserved. © FANUC 2017



# 328

## Auxiliary / Spindle Speed Functions

# Spindle Serial Output

## Features

A speed command is output to the spindle motor according to the specified spindle speed.

This function is a basic function in FANUC Series 0i-MF and 0i-TF.

## Benefits

- Permits Contouring C axis capability
- Single point threads capability
- Allows for spindle orientation
- Better interface as compared to Analog
- Can have 2 serial spindles per path

## Ordering Information

Specification	Description
A02B-0323-J850	30i-B Spindle Serial Output
A02B-0326-J850	31i-B5 Spindle Serial Output
A02B-0327-J850	31i-B Spindle Serial Output
A02B-0328-J850	32i-B Spindle Serial Output
A02B-0333-J850	35i-B Spindle Serial Output

### Notice

Certain functions may require additional hardware, different CPU type or additional memory capacity or may cause compatibility issue with other functions. In case of doubt, contact your FANUC sales representative for additional information and support.

The information given in the FANUC manuals or original manufacturer documentation shall prevail. Technical data is subject to change without prior notice. No part of this document may be reproduced in any form. All rights reserved. © FANUC 2017

# 329

## Auxiliary / Spindle Speed Functions

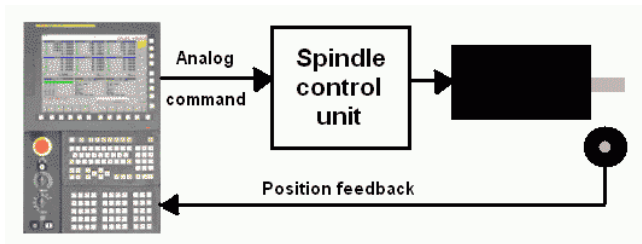

## Spindle Analog Output

### Features

Allows speed proportional to analog output voltage command on S code.

This function is a basic function in FANUC Series 0i-MF and 0i-TF.

### Benefits

- Allows speed proportional to analog output voltage command on S code
- Constant surface speed control possible
- Third party spindles can be interfaced

### Ordering Information

Specification	Description
A02B-0323-J860	30i-B Spindle Analog Output Function
A02B-0326-J860	31i-B5 Spindle Analog Output Function
A02B-0327-J860	31i-B Spindle Analog Output Function
A02B-0328-J860	32i-B Spindle Analog Output Function
A02B-0333-J860	35i-B Spindle Analog Output Function

#### Notice

Certain functions may require additional hardware, different CPU type or additional memory capacity or may cause compatibility issue with other functions. In case of doubt, contact your FANUC sales representative for additional information and support.

The information given in the FANUC manuals or original manufacturer documentation shall prevail. Technical data is subject to change without prior notice. No part of this document may be reproduced in any form. All rights reserved. © FANUC 2017

# 330

## Auxiliary / Spindle Speed Functions

# Constant Surface Speed Control

## Features

When a surface speed (in m/min or feet/min) is specified with an S code (a numeric value following S), the spindle speed is controlled so that the surface speed is kept constant with respect to the change in tool position.

This function is a basic function in FANUC Series 0i-MF and 0i-TF.

## Benefits

- Spindle speed adjusted automatically to maintain constant amount of material
- Typical example are surface grinders: as diameter increases speed reduces thereby improving surface finish, reducing tool wear while maintaining constant material removal rate

## Ordering Information

Specification	Description
A02B-0323-J855	30i-B Constant Surface Speed Control
A02B-0326-J855	31i-B5 Constant Surface Speed Control
A02B-0327-J855	31i-B Constant Surface Speed Control
A02B-0328-J855	32i-B Constant Surface Speed Control
A02B-0333-J855	35i-B Constant Surface Speed Control

### Notice

Certain functions may require additional hardware, different CPU type or additional memory capacity or may cause compatibility issue with other functions. In case of doubt, contact your FANUC sales representative for additional information and support.

The information given in the FANUC manuals or original manufacturer documentation shall prevail. Technical data is subject to change without prior notice. No part of this document may be reproduced in any form. All rights reserved. © FANUC 2017

# 331

## Auxiliary / Spindle Speed Functions

# Actual Spindle Speed Output

## Features

The actual spindle speed calculated from the spindle motor position coder feedback signal is output in 16-bit binary code.

This function is a basic function in FANUC Series 0i-TF.

## Benefits

- Simplification of the programming

## Ordering Information

Specification	Description
A02B-0323-J856	30i-B Actual Spindle Speed Output
A02B-0326-J856	31i-B5 Actual Spindle Speed Output
A02B-0327-J856	31i-B Actual Spindle Speed Output
A02B-0328-J856	32i-B Actual Spindle Speed Output
A02B-0333-J856	35i-B Actual Spindle Speed Output

### Notice

Certain functions may require additional hardware, different CPU type or additional memory capacity or may cause compatibility issue with other functions. In case of doubt, contact your FANUC sales representative for additional information and support.

The information given in the FANUC manuals or original manufacturer documentation shall prevail. Technical data is subject to change without prior notice. No part of this document may be reproduced in any form. All rights reserved. © FANUC 2017

# 332

## Auxiliary / Spindle Speed Functions

# Spindle Orientation

## Features

Spindle orientation can be performed by simply mounting a position coder on the spindle thereby stopping the spindle at fixed point.

This function is a basic function in FANUC Series 0i-MF and 0i-TF.

## Benefits

- No need to mount stoppers or pins to physically stop the spindle at same location every time
- Minimizes mechanical parts and improves accuracy and machine life
- Accuracy of orientation even at high speeds reduces cycle time
- Permits precise tool changes
- Orientation can be done either from machine operator panel or by simple M command

## Ordering Information

Specification	Description
A02B-0323-J853	30i-B Spindle Orientation for One Spindle
A02B-0326-J853	31i-B5 Spindle Orientation for One Spindle
A02B-0327-J853	31i-B Spindle Orientation for One Spindle
A02B-0328-J853	32i-B Spindle Orientation for One Spindle
A02B-0333-J853	35i-B Spindle Orientation for One Spindle

### Notice

Certain functions may require additional hardware, different CPU type or additional memory capacity or may cause compatibility issue with other functions. In case of doubt, contact your FANUC sales representative for additional information and support.

The information given in the FANUC manuals or original manufacturer documentation shall prevail. Technical data is subject to change without prior notice. No part of this document may be reproduced in any form. All rights reserved. © FANUC 2017

# 333

## Auxiliary / Spindle Speed Functions

# Spindle Output Switching Function

## Features

The Spindle Output Switching functions allows to switch seamlessly between the two windings of the spindle motor. One winding is used for low speed and the other winding for high speed. This provides a stable output for the spindle motor over a large speed range.

This function is a basic function in FANUC Series 0i-MF and 0i-TF.

## Benefits

- Constant characteristic over a wide speed range of the spindle
- Increases the quality output of the machine

## Ordering Information

Specification	Description
A02B-0323-J854	30i-B Spindle Output Switching for One Spindle (Speed-Range Switching)
A02B-0326-J854	31i-B5 Spindle Output Switching for One Spindle (Speed-Range Switching)
A02B-0327-J854	31i-B Spindle Output Switching for One Spindle (Speed-Range Switching)
A02B-0328-J854	32i-B Spindle Output Switching for One Spindle (Speed-Range Switching)
A02B-0333-J854	35i-B Spindle Output Switching for One Spindle (Speed-Range Switching)

### Notice

Certain functions may require additional hardware, different CPU type or additional memory capacity or may cause compatibility issue with other functions. In case of doubt, contact your FANUC sales representative for additional information and support.

The information given in the FANUC manuals or original manufacturer documentation shall prevail. Technical data is subject to change without prior notice. No part of this document may be reproduced in any form. All rights reserved. © FANUC 2017

# 334

## Auxiliary / Spindle Speed Functions

# Spindle Synchronous Control

## Features

In a machine having two or more spindles (such as a multi-path lathe), this function provides a way to synchronize the spindles together.

When a workpiece is switched between two spindles during spindle rotation, or when the spindle speeds of two spindles are accelerated or decelerated while the spindles are holding a workpiece, the spindles can be rotated at the same speed. This is spindle speed synchronization.

When a workpiece is transferred from one spindle to the other, the rotations of the two spindles can be made in phase to each other, matching the angular displacement. This is called phase synchronization.

## Benefits

- Simplification of the handling of the spindle in multi-spindle lathes

## Ordering Information

Specification	Description
A02B-0323-J858	30i-B Spindle Synchronous Control - Incl. Spindle Tandem Control
A02B-0326-J858	31i-B5 Spindle Synchronous Control - Incl. Spindle Tandem Control
A02B-0327-J858	31i-B Spindle Synchronous Control - Incl. Spindle Tandem Control
A02B-0328-J858	32i-B Spindle Synchronous Control - Incl. Spindle Tandem Control
A02B-0333-J858	35i-B Spindle Synchronous Control - Incl. Spindle Tandem Control
A02B-0339-J858	0i-TF Spindle Synchronous Control
A02B-0340-J858	0i-MF Spindle Synchronous Control

### Notice

Certain functions may require additional hardware, different CPU type or additional memory capacity or may cause compatibility issue with other functions. In case of doubt, contact your FANUC sales representative for additional information and support.

The information given in the FANUC manuals or original manufacturer documentation shall prevail. Technical data is subject to change without prior notice. No part of this document may be reproduced in any form. All rights reserved. © FANUC 2017

# 335

## Auxiliary / Spindle Speed Functions

# Simple Spindle Synchronous Control

---

## Features

Allows second spindle to be controlled as slave to the first one.

## Benefits

- Multiple identical parts can be cut
- Double the output using two spindles
- No need to create two part programs

## Ordering Information

Specification	Description
A02B-0340-J748	0i-MF Simple Spindle Synchronous Control

### Notice

Certain functions may require additional hardware, different CPU type or additional memory capacity or may cause compatibility issue with other functions. In case of doubt, contact your FANUC sales representative for additional information and support.

The information given in the FANUC manuals or original manufacturer documentation shall prevail. Technical data is subject to change without prior notice. No part of this document may be reproduced in any form. All rights reserved. © FANUC 2017



# 336

## Auxiliary / Spindle Speed Functions

# Multi-Spindle Control

## Features

In addition to the first spindle, the second to fourth, sixth or eighth spindle, can be controlled using an S command from the CNC. The maximum number of spindle is dependant on the CNC capabilities / type.

Spindle commands are specified using a single S command as conventionally done. A spindle is selected depending on the signal from the PMC or the address P command.

Gear change between two stages can be made for additional spindles in the same manner as for the first spindle. Parameter setting provides the possibility to set a maximum spindle speed for each spindle and clamp the speed of each spindle at the corresponding maximum spindle speed.

The position coder interfaces for the second to fourth spindles can be selected and added. The additional position coders are selected by signals from the PMC.

This function is a basic function in FANUC Series 0i-TF.

## Benefits

- Simplification of the programming
- Increase of the throughput of the machine
- Overall increase of the productivity of the machine

## Ordering Information

Specification	Description
A02B-0323-J859	30i-B Multi-Spindle Control
A02B-0326-J859	31i-B5 Multi-Spindle Control
A02B-0327-J859	31i-B Multi-Spindle Control
A02B-0328-J859	32i-B Multi-Spindle Control
A02B-0333-J859	35i-B Multi-Spindle Control (Max. 4 Spindles)
A02B-0340-J859	0i-MF Multi-Spindle Control

### Notice

Certain functions may require additional hardware, different CPU type or additional memory capacity or may cause compatibility issue with other functions. In case of doubt, contact your FANUC sales representative for additional information and support.

The information given in the FANUC manuals or original manufacturer documentation shall prevail. Technical data is subject to change without prior notice. No part of this document may be reproduced in any form. All rights reserved. © FANUC 2017

# 337

## Auxiliary / Spindle Speed Functions

# Spindle Positioning

## Features

The workpiece mounted on the spindle can be positioned at a certain angle by moving the spindle attached to the spindle motor by a certain angle. This function is called the Spindle Positioning function.

During turning, use of this function allows for instance to perform a drilling operation at any position on the circumference of the workpiece.

The spindle position is detected by the position coder attached to the spindle.

Whether to use the spindle for spindle positioning (spindle positioning mode) or to use the spindle for spindle rotation (spindle rotation mode) is command by special M code (set by parameters).

This function is a basic function in FANUC Series 0i-MF and 0i-TF.

## Benefits

- Addition of machining capabilities at the circumference of a turned part
- Simplification of the programming
- Improvement of the overall machining productivity

## Ordering Information

Specification	Description
A02B-0323-J851	30i-B Spindle Positioning
A02B-0326-J851	31i-B5 Spindle Positioning
A02B-0327-J851	31i-B Spindle Positioning
A02B-0328-J851	32i-B Spindle Positioning

### Notice

Certain functions may require additional hardware, different CPU type or additional memory capacity or may cause compatibility issue with other functions. In case of doubt, contact your FANUC sales representative for additional information and support.

The information given in the FANUC manuals or original manufacturer documentation shall prevail. Technical data is subject to change without prior notice. No part of this document may be reproduced in any form. All rights reserved. © FANUC 2017

# 338

## Auxiliary / Spindle Speed Functions

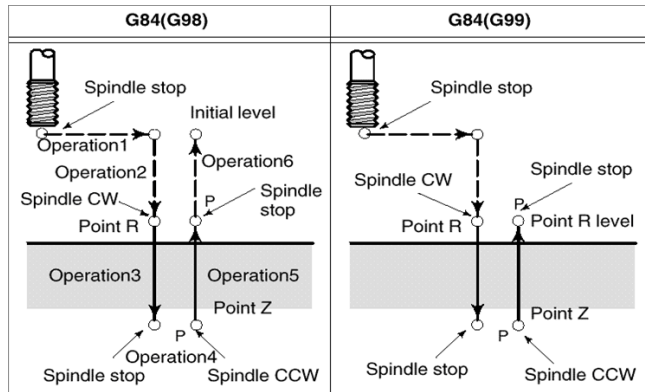

## Rigid Tapping

### Features

Rigid tapping is a function for performing high-precision tapping by exercising position control so that the spindle rotation is synchronized with tapping axis feed at all times.

In a tapping cycle (M series: G84/G74, T series: G84/G88), synchronous control is applied to the tapping operation of a tapping axis and the operation of the spindle.

This function is a basic function in FANUC Series 0i-MF and 0i-TF.

### Benefits

- Tools such as a float tapper are not needed
- Improvement of the tapped hole quality
- Reduction of tap breakage
- Reduction of tool holders cost by 50%
- Control of the depth for blind holes
- Better tap life
- Higher speed, higher precision tapping

### Ordering Information

Specification	Description
A02B-0323-J828	30i-B Rigid Tapping
A02B-0326-J828	31i-B5 Rigid Tapping
A02B-0327-J828	31i-B Rigid Tapping
A02B-0328-J828	32i-B Rigid Tapping
A02B-0333-R707	35i-B Rigid Tapping - Incl. Rigid Tapping Retract

#### Notice

Certain functions may require additional hardware, different CPU type or additional memory capacity or may cause compatibility issue with other functions. In case of doubt, contact your FANUC sales representative for additional information and support.

The information given in the FANUC manuals or original manufacturer documentation shall prevail. Technical data is subject to change without prior notice. No part of this document may be reproduced in any form. All rights reserved. © FANUC 2017

# 339

## Auxiliary / Spindle Speed Functions

# Rigid Tapping by Manual Handle

## Features

This function allows switching from a programmed command for rigid tapping to the handle mode. The tapping itself can then be performed while moving the tapping axis by manual handle.

## Benefits

- Allows operator feedback by using handle for rigid tapping to overcome hard spots in material, hole misalignment
- Ideal for repair/rework, generally for large parts
- Tapping is possible without separate set up
- Other than Z axis tapping possible
- Minimizes handling for low volume parts

## Ordering Information

Specification	Description
A02B-0323-J651	30i-B Rigid Tapping by Manual Handle
A02B-0326-J651	31i-B5 Rigid Tapping by Manual Handle
A02B-0327-J651	31i-B Rigid Tapping by Manual Handle
A02B-0328-J651	32i-B Rigid Tapping by Manual Handle
A02B-0339-J651	0i-TF Rigid Tapping by Manual Handle
A02B-0340-J651	0i-MF Rigid Tapping by Manual Handle

### Notice

Certain functions may require additional hardware, different CPU type or additional memory capacity or may cause compatibility issue with other functions. In case of doubt, contact your FANUC sales representative for additional information and support.

The information given in the FANUC manuals or original manufacturer documentation shall prevail. Technical data is subject to change without prior notice. No part of this document may be reproduced in any form. All rights reserved. © FANUC 2017

# 340

## Auxiliary / Spindle Speed Functions

# Arbitrary Position Reference Setting for Cs Axis

## Features

When a reference position return command (G28 or a manual reference position return) is executed for the first time since a serial spindle is placed in the Cs contour control mode, an arbitrary position can be set as the reference position by parameter setting.

In this case, the system performs reference position return, assuming that the current position is the reference position, so the system does not move the spindle to position it to the reference position.

Because the reference position return operation does not involve positioning to the spindle position specific to the spindle, this function can reduce the cycle time.

## Benefits

- Reduction of the cycle time
- Simplification of the programming
- Improvement of the overall machining productivity

## Ordering Information

Specification	Description
A02B-0323-S664	30i-B Arbitrary position reference setting for CS Axis
A02B-0326-S664	31i-B5 Arbitrary Position Reference Setting for CS Axis
A02B-0327-S664	31i-B Arbitrary Position Reference Setting for CS Axis
A02B-0328-S664	32i-B Arbitrary Position Reference Setting for Cs Axis
A02B-0339-S664	0i-TF Arbitrary Position Reference Setting for CS Axis
A02B-0340-S664	0i-MF Arbitrary Position Reference Setting for Cs-Axis

### Notice

Certain functions may require additional hardware, different CPU type or additional memory capacity or may cause compatibility issue with other functions. In case of doubt, contact your FANUC sales representative for additional information and support.

The information given in the FANUC manuals or original manufacturer documentation shall prevail. Technical data is subject to change without prior notice. No part of this document may be reproduced in any form. All rights reserved. © FANUC 2017

# 341

## Auxiliary / Spindle Speed Functions

# M-Code Group Check Function

## Features

The M code group check function checks if a combination of multiple M codes (up to three M codes) contained in a block is correct.

This function has two purposes:

- To detect if any of the multiple M codes specified in a block include an M code that must be specified alone
- To detect if any of the multiple M codes specified in a block include M codes that belong to the same group.

In either of these cases, alarm is issued.

## Benefits

- Addition of check function to avoid programming mistakes
- Simplification of the programming
- Improvement of the overall machining productivity

## Ordering Information

Specification	Description
A02B-0323-J922	30i-B M Code Group Check
A02B-0326-J922	31i-B5 M Code Group Check
A02B-0327-J922	31i-B M Code Group Check
A02B-0328-J922	32i-B M Code Group Check
A02B-0339-J922	0i-TF M-Code Group Check
A02B-0340-J922	0i-MF M-Code Group Check

### Notice

Certain functions may require additional hardware, different CPU type or additional memory capacity or may cause compatibility issue with other functions. In case of doubt, contact your FANUC sales representative for additional information and support.

The information given in the FANUC manuals or original manufacturer documentation shall prevail. Technical data is subject to change without prior notice. No part of this document may be reproduced in any form. All rights reserved. © FANUC 2017

# 342

## Auxiliary / Spindle Speed Functions

# Spindle Speed Fluctuation Detection

## Features

With the Spindle Speed Fluctuation Detection function, an overheat alarm OH0704 ("OVERHEAT") is raised and the spindle speed fluctuation detection alarm signal SPAL is issued when the spindle speed deviates from the specified speed due to machine conditions.

This function is useful to prevent preventing the seizure of the guide bushing.

G26 enables spindle speed fluctuation detection. G25 disables spindle speed fluctuation detection.

This function is a basic function in FANUC Series 0i-TF.

## Benefits

- Protection of machine and spindle parts
- Reduction of maintenance cases
- Improvement of the overall machining productivity

## Ordering Information

Specification	Description
A02B-0323-J857	30i-B Spindle Speed Fluctuation Detection
A02B-0326-J857	31i-B5 Spindle Speed Fluctuation Detection
A02B-0327-J857	31i-B Spindle Speed Fluctuation Detection
A02B-0328-J857	32i-B Spindle Speed Fluctuation Detection

### Notice

Certain functions may require additional hardware, different CPU type or additional memory capacity or may cause compatibility issue with other functions. In case of doubt, contact your FANUC sales representative for additional information and support.

The information given in the FANUC manuals or original manufacturer documentation shall prevail. Technical data is subject to change without prior notice. No part of this document may be reproduced in any form. All rights reserved. © FANUC 2017

# 343

## Auxiliary / Spindle Speed Functions

# Spindle Control with Servo Motor

## Features

This function allows to execute spindle rotation commands and spindle-speed functions such as rigid tapping, with a servo motor. It handles the servo motor used as a live tool axis as a single spindle. The option for spindle serial output and multi-spindle control function is necessary to use this function.

## Spindle speed control with servo motor

Allows to perform speed control with rotation commands (S commands), using a servo motor as a live tool. At the switching between rotation commands and positioning commands, no reference position return is necessary.

## Live tool indexing function

There are two types of live tool indexing functions:

- Execution of the commands in the next block without waiting for the completion of live tool indexing
- Execution of the next block after waiting for the completion of live tool indexing.

The type that does not wait for completion allows the user to specify commands for other axes before issuing the next command for the live tool indexing command axis. It also allows the user to check to see if live tool indexing has completed before issuing the next command for the live tool indexing command axis.

## Rigid tapping with servo motor

Allows to perform rigid tapping with a servo motor as a rotation axis. The option for rigid tapping and canned cycle is necessary to use rigid tapping with servo motor.

## Benefits

- Simplification of the machine structure
- Simplification of the programming
- Improvement of the overall machining productivity

## Ordering Information

Specification	Description
A02B-0323-J978	30i-B Spindle Control with Servo Motor (Live Tool Control)

### Notice

Certain functions may require additional hardware, different CPU type or additional memory capacity or may cause compatibility issue with other functions. In case of doubt, contact your FANUC sales representative for additional information and support.

The information given in the FANUC manuals or original manufacturer documentation shall prevail. Technical data is subject to change without prior notice. No part of this document may be reproduced in any form. All rights reserved. © FANUC 2017



# 344

Specification	Description
A02B-0326-J978	31i-B5 Spindle Control with Servo Motor (Live Tool Control)
A02B-0327-J978	31i-B Spindle Control with Servo Motor (Live Tool Control)
A02B-0328-J978	32i-B Spindle Control with Servo Motor (Live Tool Control)
A02B-0333-J978	35i-B Spindle Control with Servo Motor (Live Tool Control)
A02B-0339-J978	0i-TF Spindle Control with Servo Motor
A02B-0340-J978	0i-MF Spindle Control with Servo Motor

## Notice

Certain functions may require additional hardware, different CPU type or additional memory capacity or may cause compatibility issue with other functions. In case of doubt, contact your FANUC sales representative for additional information and support.

The information given in the FANUC manuals or original manufacturer documentation shall prevail. Technical data is subject to change without prior notice. No part of this document may be reproduced in any form. All rights reserved. © FANUC 2017

# 345

## Auxiliary / Spindle Speed Functions

# Spindle Control with Cs Contour Control

## Features

This function allows the execution of spindle rotation commands and spindle-speed functions such as rigid tapping, with a Cs contour control axis.

A speed control with rotation commands (S commands) is possible, using a Cs contour control axis. At the switching between rotation commands and positioning commands, no reference position return is necessary.

## Benefits

- Increase of the flexibility of the spindle control
- Simplification of the programming
- Improvement of the overall machining productivity

## Ordering Information

Specification	Description
A02B-0323-J985	30i-B Spindle Control with CS Contour Control
A02B-0326-J985	31i-B5 Spindle Control with CS Contour Control
A02B-0327-J985	31i-B Spindle Control with CS Contour Control
A02B-0328-J985	32i-B Spindle Control with CS Contour Control

### Notice

Certain functions may require additional hardware, different CPU type or additional memory capacity or may cause compatibility issue with other functions. In case of doubt, contact your FANUC sales representative for additional information and support.

The information given in the FANUC manuals or original manufacturer documentation shall prevail. Technical data is subject to change without prior notice. No part of this document may be reproduced in any form. All rights reserved. © FANUC 2017

# 346

## Auxiliary / Spindle Speed Functions

# Spindle Control Switching Function for High-Speed Machining

## Features

Generally, motion command must be given after the spindle deceleration stop and the reference position return in the case of machining after switching from spindle speed control to Cs contour control.

When the Spindle Control Switching function for High-Speed cycle machining is used with high-speed cycle machining function, it is possible to start the machining on the Cs contour control mode without stopping the spindle rotation by establishing the reference position of the Cs contour control axis while the spindle is rotating.

In addition, the control mode of the spindle can be switched from Cs contour control to spindle speed control without stopping the spindle rotation by utilizing the signal, which is outputted during high-speed cycle machining.

As the acceleration/deceleration is not performed at changing control mode, the cycle time can be reduced.

## Benefits

- Reduction of cycle time
- Increase of the machine productivity

## Ordering Information

Specification	Description
A02B-0323-R608	30i-B High-Speed Cycle Machining - Spindle Control Switching Function
A02B-0326-R608	31i-B5 High-Speed Cycle Machining - Spindle Control Switching Function
A02B-0327-R608	31i-B High-Speed Cycle Machining - Spindle Control Switching Function

### Notice

Certain functions may require additional hardware, different CPU type or additional memory capacity or may cause compatibility issue with other functions. In case of doubt, contact your FANUC sales representative for additional information and support.

The information given in the FANUC manuals or original manufacturer documentation shall prevail. Technical data is subject to change without prior notice. No part of this document may be reproduced in any form. All rights reserved. © FANUC 2017

# 347

## Auxiliary / Spindle Speed Functions

# Thread Start Position Compensation for Changing Spindle Speed

---

## Features

The thread cutting is correctly performed by this function even if the spindle override is changed in the interval of the thread cutting performing.

The spindle override can be changed only while the thread cutting is not performed.

## Benefits

- Reduction of the cycle time
- Increase of the machine productivity

## Ordering Information

Specification	Description
A02B-0323-S946	30i-B Thread Start Position Compensation in Changing Spindle Speed function
A02B-0326-S946	31i-B5 Thread Start Position Compensation in Changing Spindle Speed Function
A02B-0327-S946	31i-B Thread Start Position Compensation in Changing Spindle Speed Function
A02B-0328-S946	32i-B Thread Start Position Compensation in Changing Spindle Speed Function

### Notice

Certain functions may require additional hardware, different CPU type or additional memory capacity or may cause compatibility issue with other functions. In case of doubt, contact your FANUC sales representative for additional information and support.

The information given in the FANUC manuals or original manufacturer documentation shall prevail. Technical data is subject to change without prior notice. No part of this document may be reproduced in any form. All rights reserved. © FANUC 2017

# 348

## Auxiliary / Spindle Speed Functions

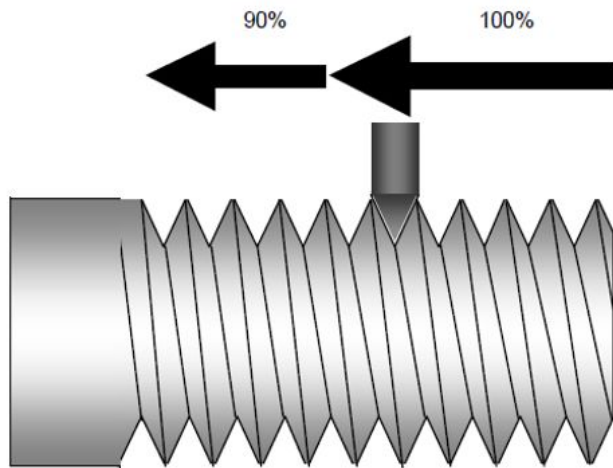

## Arbitrary Speed Threading

### Features

Spindle speed cannot be changed normally during threading because the tool movement could not synchronize with the spindle rotation. This function allows threading to change the spindle speed without losing the precision.

This function is available for constant lead threading, threading cycle, and multiple threading cycle.

Changing the spindle speed can prevent the vibration that occurs during threading at the specific spindle speed for large size machine. Besides, for repetitive machining, the same thread shape can be machined even if the spindle speed is changed between rough machining and finishing machining.

### Benefits

- Reduction of vibrations
- Improvement of the threading quality on large parts
- Increase of the machine productivity

### Ordering Information

Specification	Description
A02B-0323-R672	30i-B Arbitrary Speed Threading
A02B-0326-R672	31i-B5 Arbitrary Speed Threading
A02B-0327-R672	31i-B Arbitrary Speed Threading
A02B-0328-R672	32i-B Arbitrary Speed Threading
A02B-0339-R672	0i-TF Arbitrary Speed Threading
A02B-0340-R672	0i-MF Arbitrary Speed Threading

#### Notice

Certain functions may require additional hardware, different CPU type or additional memory capacity or may cause compatibility issue with other functions. In case of doubt, contact your FANUC sales representative for additional information and support.

The information given in the FANUC manuals or original manufacturer documentation shall prevail. Technical data is subject to change without prior notice. No part of this document may be reproduced in any form. All rights reserved. © FANUC 2017

# 349

## Auxiliary / Spindle Speed Functions

# Designation of Servo Axes for Spindle Use

## Features

Specify the number of servo axes for spindle use (movement command invalidity) in spindle control with servo motor. The number of servo axes for spindle use needs to be included in spindle axes specification. Spindle control with servo motor is required to use this option.

## Benefits

- Simplification of the machine structure
- Simplification of the programming
- Improvement of the overall machining productivity

## Ordering Information

Specification	Description
A02B-0328-R710#1	32i-B Designation of Servo Axis for Spindle Use, 1st Axis
A02B-0328-R710#2	32i-B Designation of Servo Axis for Spindle Use, 2nd Axis
A02B-0328-R710#3	32i-B Designation of Servo Axis for Spindle Use, 3rd Axis
A02B-0328-R710#4	32i-B Designation of Servo Axis for Spindle Use, 4th Axis

### Notice

Certain functions may require additional hardware, different CPU type or additional memory capacity or may cause compatibility issue with other functions. In case of doubt, contact your FANUC sales representative for additional information and support.

The information given in the FANUC manuals or original manufacturer documentation shall prevail. Technical data is subject to change without prior notice. No part of this document may be reproduced in any form. All rights reserved. © FANUC 2017

# 350

## Auxiliary / Spindle Speed Functions

## Extended Spindle Orientation

---

### Features

This function extends the spindle orientation function so that up to 8 spindle motors can be positioned simultaneously.

### Benefits

- Simplification of the programming

### Ordering Information

Specification	Description
A02B-0323-J861	30i-B Extended Spindle Orientation, Max. 8 Spindles
A02B-0326-J861	31i-B5 Extended Spindle Orientation, Max. 6 Spindles
A02B-0327-J861	31i-B Extended Spindle Orientation, Max. 6 Spindles
A02B-0328-J861	32i-B Extended Spindle Orientation, Max. 6 Spindles
A02B-0333-J861	35i-B Extended Spindle Orientation, Max. 4 Spindles

#### Notice

Certain functions may require additional hardware, different CPU type or additional memory capacity or may cause compatibility issue with other functions. In case of doubt, contact your FANUC sales representative for additional information and support.

The information given in the FANUC manuals or original manufacturer documentation shall prevail. Technical data is subject to change without prior notice. No part of this document may be reproduced in any form. All rights reserved. © FANUC 2017

# 351

## Auxiliary / Spindle Speed Functions

# Extended Spindle Output Switching Function

## Features

This function extends the Spindle Output Switching function so that winding switching can be performed for up to 8 spindle motors.

## Benefits

- Constant characteristic over a wide speed range of the spindle
- Increases the quality output of the machine

## Ordering Information

Specification	Description
A02B-0323-J862	30i-B Extended Spindle Output Switching Function, Max. 8 Spindles
A02B-0326-J862	31i-B5 Extended Spindle Output Switching Function, Max.6 Spindles
A02B-0327-J862	31i-B Extended Spindle Output Switching Function, Max. 4 Spindles
A02B-0328-J862	32i-B Extended Spindle Output Switching Function, Max. 4 Spindles
A02B-0333-J862	35i-B Extended Spindle Output Switching Function, Max. 4 Spindles

### Notice

Certain functions may require additional hardware, different CPU type or additional memory capacity or may cause compatibility issue with other functions. In case of doubt, contact your FANUC sales representative for additional information and support.

The information given in the FANUC manuals or original manufacturer documentation shall prevail. Technical data is subject to change without prior notice. No part of this document may be reproduced in any form. All rights reserved. © FANUC 2017



# 352

## Auxiliary / Spindle Speed Functions

# Spindle Axes Expansion

---

## Features

This option expands the max. number of spindle axes. In a 1-path system, the max. number is expanded to 3 spindle axes. In a 2-path system, the max. number is expanded to 4 spindle axes in total. Up to 3 spindle axes can be used in one path.

## Benefits

- Extends the application range of the FANUC 0i-F series

## Ordering Information

Specification	Description
A02B-0339-R604	0i-TF Spindle Axes Expansion
A02B-0340-R604	0i-MF Spindle Axes Expansion

### Notice

Certain functions may require additional hardware, different CPU type or additional memory capacity or may cause compatibility issue with other functions. In case of doubt, contact your FANUC sales representative for additional information and support.

The information given in the FANUC manuals or original manufacturer documentation shall prevail. Technical data is subject to change without prior notice. No part of this document may be reproduced in any form. All rights reserved. © FANUC 2017

# 353

## Auxiliary / Spindle Speed Functions

# Spindle Serial/Analog Output

## Features

An analog spindle can be used with serial spindles at the same time. An analog spindle can be used for one of the controlled spindle axes of the system.

In this function, the spindle output control and the spindle output control by the PMC can be used for an analog spindle.

## Benefits

- Possibility to mix analog and digital spindle control
- Improvement of the machine flexibility

## Ordering Information

Specification	Description
A02B-0323-R584	30i-B Serial / Analog Spindle Control
A02B-0326-R584	31i-B5 Serial / Analog Spindle Control
A02B-0327-R584	31i-B Serial / Analog Spindle Control
A02B-0328-R584	32i-B Serial / Analog Spindle Control

### Notice

Certain functions may require additional hardware, different CPU type or additional memory capacity or may cause compatibility issue with other functions. In case of doubt, contact your FANUC sales representative for additional information and support.

The information given in the FANUC manuals or original manufacturer documentation shall prevail. Technical data is subject to change without prior notice. No part of this document may be reproduced in any form. All rights reserved. © FANUC 2017

# 354

## Auxiliary / Spindle Speed Functions

# Spindle Switching Function

## Features

The Spindle Switching function can realize the spindle control in arbitrary combination of spindle motors and commands to a spindle.

The combination of spindle motors and commands can be switched by the signals of the spindle switching function.

## Benefits

- Increase of the flexibility of the machine
- Simplification of programming
- Overall increase of the machining productivity

## Ordering Information

Specification	Description
A02B-0323-R515	30i-B Flexible Path Spindle Assignment
A02B-0326-R515	31i-B5 Flexible Path Spindle Assignment
A02B-0327-R515	31i-B Flexible Path Spindle Assignment
A02B-0328-R515	32i-B Flexible Path Spindle Assignment

### Notice

Certain functions may require additional hardware, different CPU type or additional memory capacity or may cause compatibility issue with other functions. In case of doubt, contact your FANUC sales representative for additional information and support.

The information given in the FANUC manuals or original manufacturer documentation shall prevail. Technical data is subject to change without prior notice. No part of this document may be reproduced in any form. All rights reserved. © FANUC 2017

# 355

## Auxiliary / Spindle Speed Functions

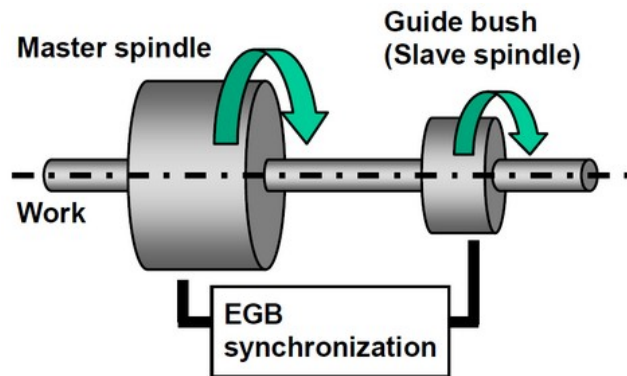

## Spindle Synchronous Control for Guide Bush

### Features

In order to control an axis (slave spindle axis) to follow an axis (master spindle axis) synchronously between two spindle axes, the function “Spindle Electronic Gear Box” called “Spindle EGB” or “Simple spindle EGB” can be used. Both functions require Cs contour control to the slave axis.

With the “Spindle Synchronous Control for Guide Bush”, a similar functionality as for the Simple Spindle EGB can be realized WITHOUT using Cs contour control for the slave axis.

When this function is used, the additional control axis is not necessary because there is no Cs contour control axis.

### Benefits

- Simplification of the implementation of spindle synchronization for a rotary guide bush

### Ordering Information

Specification	Description
A02B-0323-R420	30i-B Spindle Synchronous Control for Guide Bush
A02B-0326-R420	31i-B5 Spindle Synchronous Control for Guide Bush
A02B-0327-R420	31i-B Spindle Synchronous Control for Guide Bush
A02B-0328-R420	32i-B Spindle Synchronous Control for Guide Bush
A02B-0339-R420	0i-TF Spindle Synchronous Control for Guide Bush
A02B-0340-R420	0i-MF Spindle Synchronous Control for Guide Bush

### Notice

Certain functions may require additional hardware, different CPU type or additional memory capacity or may cause compatibility issue with other functions. In case of doubt, contact your FANUC sales representative for additional information and support.

The information given in the FANUC manuals or original manufacturer documentation shall prevail. Technical data is subject to change without prior notice. No part of this document may be reproduced in any form. All rights reserved. © FANUC 2017

# 356

## Functions

## Tool Functions / Tool Compensation

---

This section of the catalogue contains the functions related to Tool Management and Tool compensation.

Some of the functions detailed in the catalogue:

- Tool offset
- Tool Center Point control (TCP)
- Smooth TCP
- Automatic compensation
- Geometry compensation
- Tool wear compensation
- Advanced Tool Management
- Wheel wear compensation
- Etc.

### Notice

Certain functions may require additional hardware, different CPU type or additional memory capacity or may cause compatibility issue with other functions. In case of doubt, contact your FANUC sales representative for additional information and support.

The information given in the FANUC manuals or original manufacturer documentation shall prevail. Technical data is subject to change without prior notice. No part of this document may be reproduced in any form. All rights reserved. © FANUC 2017

# 357

## Tool Functions / Tool Compensation

### Tool Offset Pairs

#### Features

This function enhances the maximum number of tool offset to a higher maximum value. The tool offset number is specified with the last three digits in T-code value. The tool offset number is specified with the remaining digits after excluding the three digits used to specify the tool offset number.

The maximum size of the tool offset depends on the type of CNC. Refer to the ordering information table for further details.

#### Benefits

- Increase of the tool capability of the CNC
- Increase of the flexibility of the machine

#### Ordering Information

Specification	Description
A02B-0323-J721	30i-B Tool Offset, 999 Pairs
A02B-0323-J925	30i-B Tool Offset, 64 Pairs
A02B-0323-J926	30i-B Tool Offset, 99 Pairs
A02B-0323-J927	30i-B Tool Offset, 200 Pairs
A02B-0323-J928	30i-B Tool Offset, 400 Pairs
A02B-0323-S614	30i-B Tool Offset, 499 Pairs
A02B-0323-S622	30i-B Tool Offset, 2000 Pairs (up to 999 Pairs Available in Each Path)
A02B-0326-J721	31i-B5 Tool Offset, 999 Pairs
A02B-0326-J925	31i-B5 Tool Offset, 64 Pairs
A02B-0326-J926	31i-B5 Tool Offset, 99 Pairs
A02B-0326-J927	31i-B5 Tool Offset, 200 Pairs
A02B-0326-J928	31i-B5 Tool Offset, 400 Pairs
A02B-0326-S614	31i-B5 Tool Offset, 499 Pairs
A02B-0326-S622	31i-B5 Tool Offset, 2000 Pairs (up to 999 Pairs Available in Each Path)
A02B-0327-J721	31i-B Tool Offset, 999 Pairs
A02B-0327-J925	31i-B Tool Offset, 64 Pairs
A02B-0327-J926	31i-B Tool Offset, 99 Pairs
A02B-0327-J927	31i-B Tool Offset, 200 Pairs
A02B-0327-J928	31i-B Tool Offset, 400 Pairs
A02B-0327-S614	31i-B Tool Offset, 499 Pairs

#### Notice

Certain functions may require additional hardware, different CPU type or additional memory capacity or may cause compatibility issue with other functions. In case of doubt, contact your FANUC sales representative for additional information and support.

The information given in the FANUC manuals or original manufacturer documentation shall prevail. Technical data is subject to change without prior notice. No part of this document may be reproduced in any form. All rights reserved. © FANUC 2017

Specification	Description
A02B-0327-S622	31i-B Tool Offset, 2000 Pairs (up to 999 Pairs Available in Each Path)
A02B-0328-J925	32i-B Tool Offset, 64 Pairs
A02B-0328-J926	32i-B Tool Offset, 99 Pairs
A02B-0328-J927	32i-B Tool Offset, 200 Pairs
A02B-0328-J928	32i-B Tool Offset, 400 Pairs
A02B-0333-J927	35i-B Tool Offset, 200 Pairs
A02B-0334-J927	PM i-A Tool Offset, 200 Pairs
A02B-0339-J927	0i-TF Tool Offset Pairs, 200 Pairs

## Notice

Certain functions may require additional hardware, different CPU type or additional memory capacity or may cause compatibility issue with other functions. In case of doubt, contact your FANUC sales representative for additional information and support.

The information given in the FANUC manuals or original manufacturer documentation shall prevail. Technical data is subject to change without prior notice. No part of this document may be reproduced in any form. All rights reserved. © FANUC 2017

# 359

## Tool Functions / Tool Compensation

# Tool Offset Memory B

## Features

Tool Offset Memory B provides separate offsets for geometry compensation and wear compensation. There is no difference between cutter compensation (D code) and tool length compensation (H code).

## Setting Example for Tool Compensation Memory B

Offset Number	Compensation Value (Geometry)	Compensation Value (Wear)	Common to D and H Codes
001	10100	0,100	for D code
002	20200	0,200	for D code
003	100000	0,100	for H code
...	...	...	...

## Benefits

- Addition of the Tool Offset Memory B to the CNC
- Simplification of the programming
- Improvement of the overall machining productivity

## Ordering Information

Specification	Description
A02B-0323-S616	30i-B Tool Offset Memory B
A02B-0326-S616	31i-B5 Tool Offset Memory B
A02B-0327-S616	31i-B Tool Offset Memory B
A02B-0328-S616	32i-B Tool Offset Memory B

### Notice

Certain functions may require additional hardware, different CPU type or additional memory capacity or may cause compatibility issue with other functions. In case of doubt, contact your FANUC sales representative for additional information and support.

The information given in the FANUC manuals or original manufacturer documentation shall prevail. Technical data is subject to change without prior notice. No part of this document may be reproduced in any form. All rights reserved. © FANUC 2017



# 360

## Tool Functions / Tool Compensation

# Tool Offset Memory C

## Features

Tool Offset Memory C provides for geometry compensation and wear compensation in separate tool compensation memory. Geometry compensation and wear compensation can thus be set separately. Separate memories are prepared for cutter compensation (for D code) and for tool length compensation (for H code).

## Setting Example for Tool Compensation Memory C

Offset Number	D Code		H Code	
	Compensation Value (Geometry)	Compensation Value (Wear)	Compensation Value (Geometry)	Compensation Value (Wear)
001	10000	0,100	100000	0,100
002	20000	0,200	200000	0,300
...	...	...	...	...

This function is a basic function in FANUC Series 0i-MF.

## Benefits

- Addition of the Tool Offset Memory C to the CNC
- Simplification of the programming
- Improvement of the overall machining productivity

## Ordering Information

Specification	Description
A02B-0323-J937	30i-B Tool Offset Memory C
A02B-0326-J937	31i-B5 Tool Offset Memory C
A02B-0327-J937	31i-B Tool Offset Memory C
A02B-0328-J937	32i-B Tool Offset Memory C
A02B-0333-J937	35i-B Tool Offset Memory C

### Notice

Certain functions may require additional hardware, different CPU type or additional memory capacity or may cause compatibility issue with other functions. In case of doubt, contact your FANUC sales representative for additional information and support.

The information given in the FANUC manuals or original manufacturer documentation shall prevail. Technical data is subject to change without prior notice. No part of this document may be reproduced in any form. All rights reserved. © FANUC 2017

# 361

## Tool Functions / Tool Compensation

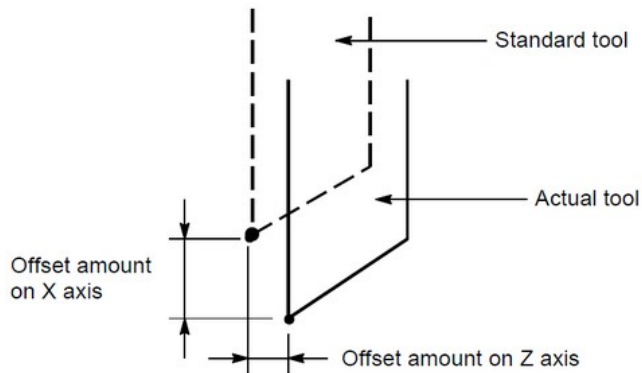

## Tool Offset

### Features

The Tool Offset function is an option on the milling software of the Series 30i CNC. The programmed travel distance of the tool can be increased or decreased by a specified tool offset value or by twice the offset value. The Tool Offset function can also be applied to an additional axis.

The Tool Offset function is standard in the turning software of the Series 30i CNC. It is used to compensate for the difference when the tool actually used differs from the imagined tool used in programming (usually standard tool).

This function is a basic function in FANUC Series 0i-MF and 0i-TF.

### Benefits

- Simplifies the operation of the machine
- Improves machining productivity

### Ordering Information

Specification	Description
A02B-0323-S617	30i-B Tool Offset
A02B-0326-S617	31i-B5 Tool Offset
A02B-0327-S617	31i-B Tool Offset
A02B-0328-S617	32i-B Tool Offset

#### Notice

Certain functions may require additional hardware, different CPU type or additional memory capacity or may cause compatibility issue with other functions. In case of doubt, contact your FANUC sales representative for additional information and support.

The information given in the FANUC manuals or original manufacturer documentation shall prevail. Technical data is subject to change without prior notice. No part of this document may be reproduced in any form. All rights reserved. © FANUC 2017

# 362

## Tool Functions / Tool Compensation

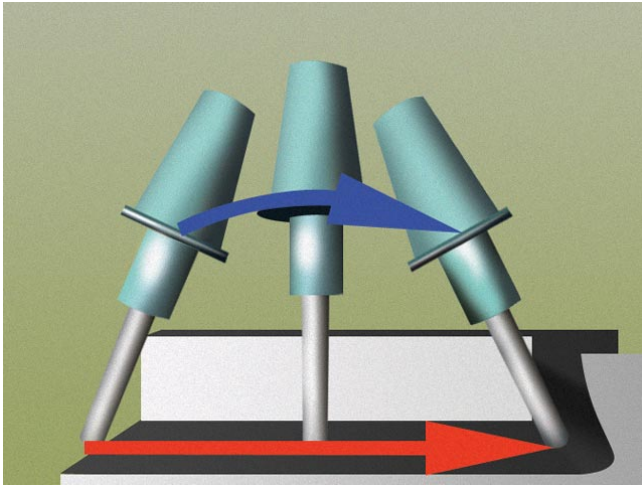

## Tool Center Point Control

### Features

On a 5-axis machine having two rotary axes that turn a tool or table, this function performs tool length compensation constantly, even in the middle of a block, and exerts control so that the tool center point moves along the specified path.

### Benefits

- The tool center point will move along the specified path even if the direction of the tool changes with respect to the workpiece.
- May be used with all classes of 5-axes machine tools
- Uniform parameters with other 5-axes functions.

### Ordering Information

Specification	Description
A02B-0323-S677	30i-B Tool Center Point Control
A02B-0326-S677	31i-B5 Tool Center Point Control
A02B-0327-S677	31i-B Tool Center Point Control
A02B-0328-S677	32i-B Tool Center Point Control

#### Notice

Certain functions may require additional hardware, different CPU type or additional memory capacity or may cause compatibility issue with other functions. In case of doubt, contact your FANUC sales representative for additional information and support.

The information given in the FANUC manuals or original manufacturer documentation shall prevail. Technical data is subject to change without prior notice. No part of this document may be reproduced in any form. All rights reserved. © FANUC 2017

# 363

## Tool Functions / Tool Compensation

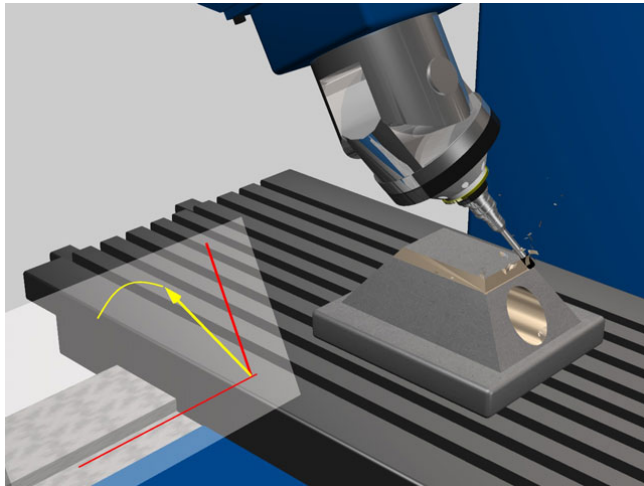

## Tool Posture Control

### Features

The function of Tool Posture Control, former Tool Posture Control of Tool Center Point Control for 5-Axis Machining, is in a way an extension of Tool Center Point Control, which controls the path of the tool centre point on a straight line.

Additionally the control of the tool is linked to the vector between the start and end point such that unintentional stock removal by the side of the cutting tool is avoided. Tool Posture Control is mainly used in side cutting, if pockets or forms with varying angles are being milled.

### Benefits

- Usage of different tool cutter radius for side cutting in 5-axis machining
- Higher machining flexibility
- Machining of complex 5-axis parts (e.g. pyramids and cones)

### Ordering Information

Specification	Description
A02B-0323-S994	30i-B Tool Posture Control of Tool Center Point Control (TCP) for 5-Axes Machining
A02B-0326-S994	31i-B5 Tool Posture Control of Tool Center Point Control (TCP) for 5-Axes Machining

#### Notice

Certain functions may require additional hardware, different CPU type or additional memory capacity or may cause compatibility issue with other functions. In case of doubt, contact your FANUC sales representative for additional information and support.

The information given in the FANUC manuals or original manufacturer documentation shall prevail. Technical data is subject to change without prior notice. No part of this document may be reproduced in any form. All rights reserved. © FANUC 2017

# 364

## Tool Functions / Tool Compensation

# Cutting Point Command

## Features

Whether when using end, ball or bull-nose milling tools, the Cutting Point Command function enables the definition of the orientation of the tool relative to the programmed path – information that previously would have had to be input to the CAM system. Now an operator may determine the optimum cutting conditions at the machine and the FANUC CNC will internally re-calculate the required tool path.

## Benefits

- Reduced Setup/Machining Time
- Cutting conditions can be easily adjusted/optimized by the operator
- Same part program can be used with various tools such as end, ball or bull-nose milling tools

## Ordering Information

Specification	Description
A02B-0323-S996	30i-B Cutting Point Command
A02B-0326-S996	31i-B5 Cutting Point Command

### Notice

Certain functions may require additional hardware, different CPU type or additional memory capacity or may cause compatibility issue with other functions. In case of doubt, contact your FANUC sales representative for additional information and support.

The information given in the FANUC manuals or original manufacturer documentation shall prevail. Technical data is subject to change without prior notice. No part of this document may be reproduced in any form. All rights reserved. © FANUC 2017

# 365

## Tool Functions / Tool Compensation

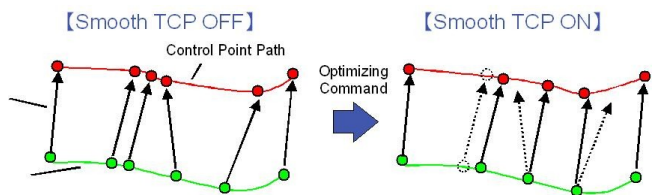

## Smooth TCP

### Features

The function Smooth TCP is based on the Tool Center Point Control function and compensates deviations in the tool orientation.

In addition Smooth TCP also ignores redundant commands with regard to the tool centre-point position.

### Benefits

- Shorter cycle times (in extreme cases, time savings of up to 44%)
- Smoother surfaces
- Minimisation of machine or tool wear due to avoidance of jerk in the motion profile

### Ordering Information

Specification	Description
A02B-0323-R639	30i-B Smooth Tool Center Point Control (TCP)
A02B-0326-R639	31i-B5 Smooth Tool Center Point Control (TCP)
A02B-0327-R639	31i-B Smooth Tool Center Point Control (TCP)

#### Notice

Certain functions may require additional hardware, different CPU type or additional memory capacity or may cause compatibility issue with other functions. In case of doubt, contact your FANUC sales representative for additional information and support.

The information given in the FANUC manuals or original manufacturer documentation shall prevail. Technical data is subject to change without prior notice. No part of this document may be reproduced in any form. All rights reserved. © FANUC 2017

# 366

## Tool Functions / Tool Compensation

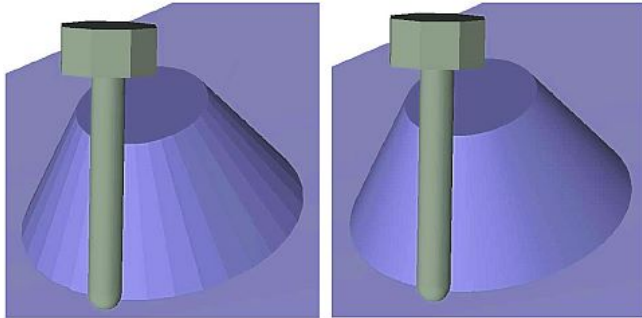

## High-Speed Smooth TCP

### Features

Under Tool Posture Control, the tool posture is controlled every moment for operation on the plane formed by the tool postures (tool length compensation vectors) at the start point and the end point of a block.

This control method is suitable for machining a plane with the side of a tool using the tool center point control.

Adding to the Tool Posture Control, the High-Speed Smooth TCP function generates and interpolates smooth surfaces from commanded tool center points and tool postures.

Traditionally, when a free surface is machined by Tool Posture Control, the free surface is approximated by polyhedrons (left illustration). When using the Smooth TCP, the free surface can be machined with smooth surfaces and the machining quality can be improved (right illustration).

This feature is suitable for machining free surfaces with tool side using Tool Center Point control. This feature has two modes, one is Speed priority mode in which speed has higher priority and the other is Surface quality priority mode in which quality of machining surface has higher priority. One of those modes can be selected by a command.

### Benefits

- Shorter cycle times (in extreme cases, time savings of up to 44%)
- Smoother surfaces
- Minimisation of machine or tool wear due to avoidance of jerk in the motion profile

### Ordering Information

Specification	Description
A02B-0323-R677	30i-B High-Speed Smooth TCP (Tool Center Point Control) - Incl. Smooth TCP, Tool Posture Control, Cutting Point Command Expansion of Axis Command in TCP Control
A02B-0326-R677	31i-B5 High-Speed Smooth TCP (Tool Center Point Control) - Incl. Smooth TCP, Tool Posture Control, Cutting Point Command Expansion of Axis Command in TCP Control

#### Notice

Certain functions may require additional hardware, different CPU type or additional memory capacity or may cause compatibility issue with other functions. In case of doubt, contact your FANUC sales representative for additional information and support.

The information given in the FANUC manuals or original manufacturer documentation shall prevail. Technical data is subject to change without prior notice. No part of this document may be reproduced in any form. All rights reserved. © FANUC 2017

# 367

## Tool Functions / Tool Compensation

# Expansion of Axis Command in Tool Center Point Control

---

## Features

In the tool center point control mode, this function enables to command an axis which is not controlled by tool center point control ("non 5-axis machining control axis"). This allows to move peripheral axes during tool center point control mode. The maximum number of non 5-axis machining control axes which can be specified in one block is 10 axes in 30i-B series, 2 axes in 31i-B5 series and 1 axis in 31i-B series.

## Benefits

- Move peripheral axes during 5-axis machining and reduce cycle time

## Ordering Information

Specification	Description
A02B-0323-R592	30i-B Expansion of Axis Command in Tool Center Point Control (TCP), for Linear Interpolation G01
A02B-0326-R592	31i-B5 Expansion of Axis Command in Tool Center Point Control (TCP), for Linear Interpolation G01
A02B-0327-R592	31i-B Expansion of Axis Command in Tool Center Point Control (TCP), for Linear Interpolation G01

### Notice

Certain functions may require additional hardware, different CPU type or additional memory capacity or may cause compatibility issue with other functions. In case of doubt, contact your FANUC sales representative for additional information and support.

The information given in the FANUC manuals or original manufacturer documentation shall prevail. Technical data is subject to change without prior notice. No part of this document may be reproduced in any form. All rights reserved. © FANUC 2017



# 368

## Tool Functions / Tool Compensation

### Y-Axis Offset

---

#### Features

Y-Axis Offset function is used in turning controls equipped with a third linear axis. When the Y axis, one of the basic three axes, is used with a lathe system, this function performs Y axis offset.

If the tool geometry / wear offset options are provided, both tool geometry offset and tool wear offset are effective to Y axis offset.

This function is a basic function in FANUC Series 0i-TF.

#### Benefits

- Addition of an additional offset capability for the Y axis
- Simplification of the programming
- Improvement of the overall machining productivity

#### Ordering Information

Specification	Description
A02B-0323-J934	30i-B Y-Axis Offset
A02B-0326-J934	31i-B5 Y-Axis Offset
A02B-0327-J934	31i-B Y-Axis Offset
A02B-0328-J934	32i-B Y-Axis Offset

#### Notice

Certain functions may require additional hardware, different CPU type or additional memory capacity or may cause compatibility issue with other functions. In case of doubt, contact your FANUC sales representative for additional information and support.

The information given in the FANUC manuals or original manufacturer documentation shall prevail. Technical data is subject to change without prior notice. No part of this document may be reproduced in any form. All rights reserved. © FANUC 2017

# 369

## Tool Functions / Tool Compensation

### 4th/5th Axis Offset

---

#### Features

This function performs the tool offset for the 4th and the 5th axis following the basic three axes X, Z, Y. The number of tool offset pairs are 32 pairs, the same as for the X, Z, Y axis.

It is possible to divide into a tool wear offset and a tool geometry offset by specifying a option. The number of 32 pairs can be optionally extended to 64, 99, 400, 999, 2000 pairs. The number of maximum pairs depends on the CNC type.

#### Benefits

- Addition of tool offset for the 4th and 5th axis
- Simplification of the programming
- Improvement of the overall machining productivity

#### Ordering Information

Specification	Description
A02B-0323-R517	30i-B 4th / 5th Axis Offset (Lathe System)
A02B-0326-R517	31i-B5 4th / 5th Axis Offset (Lathe System)
A02B-0327-R517	31i-B 4th / 5th Axis Offset (Lathe System)
A02B-0328-R517	32i-B 4th / 5th Axis Offset (Lathe System)
A02B-0339-R517	0i-TF 4th/5th Axis Offset

#### Notice

Certain functions may require additional hardware, different CPU type or additional memory capacity or may cause compatibility issue with other functions. In case of doubt, contact your FANUC sales representative for additional information and support.

The information given in the FANUC manuals or original manufacturer documentation shall prevail. Technical data is subject to change without prior notice. No part of this document may be reproduced in any form. All rights reserved. © FANUC 2017

# 370

## Tool Functions / Tool Compensation

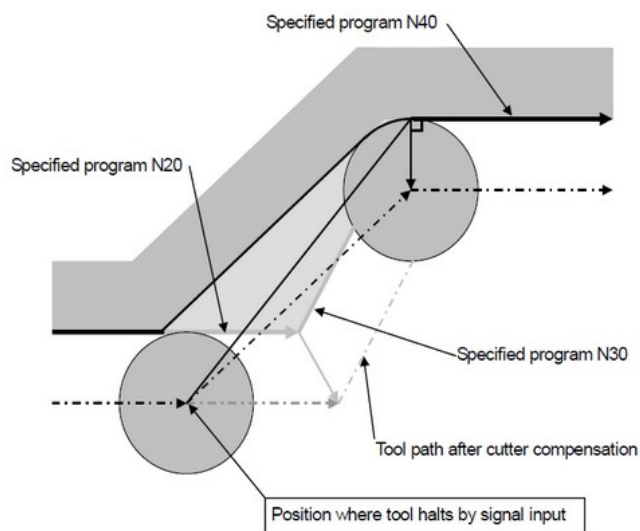

## Tool Radius / Tool Nose Radius Compensation

### Features

The Tool Radius Compensation function can offset a programmed tool path by the tool radius set in the CNC when machining is performed.

When the radius of the tool to be used for machining is measured and set as the offset value in the CNC, the tool moves along the offset path to cut a programmed profile. As a consequence, when the tool diameter changes, only the offset value needs to be changed and it is not necessary to modify the program.

To obtain the actual offset tool path, the CNC internally calculates intersections of a straight line and a straight line, an arc and an arc, and a straight line and an arc automatically. The programmer only has to program a machining profile, therefore the programming can be done very easily.

This function is a basic function in FANUC Series 0i-F.

### Benefits

- Simplification of the programming
- Improvement of the overall machining productivity

### Ordering Information

Specification	Description
A02B-0323-J930	30i-B Tool Radius (Cutter) Compensation and Tool Nose Radius Compensation
A02B-0326-J930	31i-B5 Tool Radius (Cutter) Compensation and Tool Nose Radius Compensation
A02B-0327-J930	31i-B Tool Radius (Cutter) Compensation and Tool Nose Radius Compensation
A02B-0328-J930	32i-B Tool Radius (Cutter) Compensation and Tool Nose Radius Compensation
A02B-0333-J930	35i-B Tool Radius (Cutter) Compensation

### Notice

Certain functions may require additional hardware, different CPU type or additional memory capacity or may cause compatibility issue with other functions. In case of doubt, contact your FANUC sales representative for additional information and support.

The information given in the FANUC manuals or original manufacturer documentation shall prevail. Technical data is subject to change without prior notice. No part of this document may be reproduced in any form. All rights reserved. © FANUC 2017

# 371

## Tool Functions / Tool Compensation

# Automatic Tool Nose Radius Compensation

## Features

When using the Tool Nose Radius Compensation function, it is necessary to command the direction offset by G41 / G42 depending on the cutting direction.

With the Automatic Tool Nose Radius Compensation function, it is possible to determinand set the direction offset automatically according to the current cutting direction.

## Benefits

- Easy Programming

## Ordering Information

Specification	Description
A02B-0323-S942	30i-B Automatic Tool Nose Radius Compensation
A02B-0326-S942	31i-B5 Automatic Tool Nose Radius Compensation
A02B-0327-S942	31i-B Automatic Tool Nose Radius Compensation
A02B-0328-S942	32i-B Automatic Tool Nose Radius Compensation

### Notice

Certain functions may require additional hardware, different CPU type or additional memory capacity or may cause compatibility issue with other functions. In case of doubt, contact your FANUC sales representative for additional information and support.

The information given in the FANUC manuals or original manufacturer documentation shall prevail. Technical data is subject to change without prior notice. No part of this document may be reproduced in any form. All rights reserved. © FANUC 2017

# 372

## Tool Functions / Tool Compensation

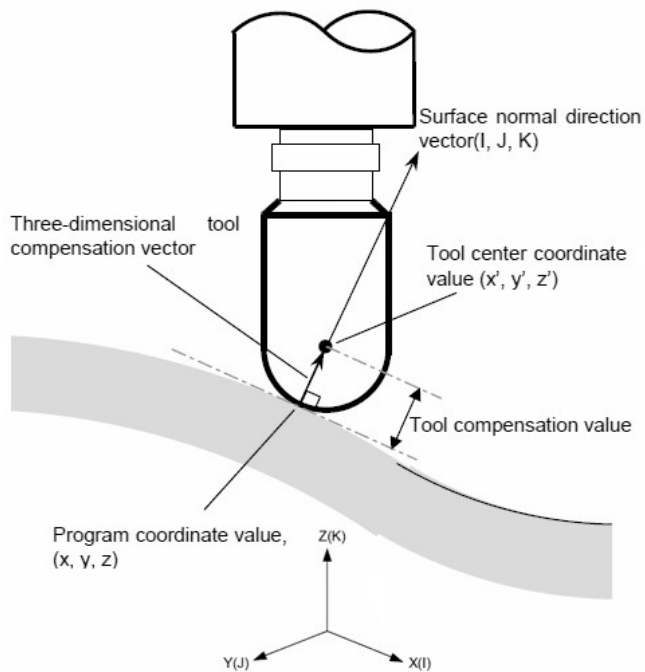

### Notice

Certain functions may require additional hardware, different CPU type or additional memory capacity or may cause compatibility issue with other functions. In case of doubt, contact your FANUC sales representative for additional information and support.

The information given in the FANUC manuals or original manufacturer documentation shall prevail. Technical data is subject to change without prior notice. No part of this document may be reproduced in any form. All rights reserved. © FANUC 2017

## 3-Dimensional Tool Compensation

### Features

The 3-Dimensional Tool Compensation function, used on machines having three basic orthogonal axes, calculates a compensation vector perpendicular to the machining surface as a three-dimensional compensation vector.

Typically, this function is used for ball-nosed cutters on 3-axis machines.

This function is different from the similar 5-axis compensation functions.

### Benefits

- Programming uncompensated surface coordinates of free-form 3D sculptured surfaces typically in Die and Mold applications
- 3-dimensional compensation for ball-nosed cutters
- Can easily change to a different sized ball-nosed cutter without re-calculating the part surface coordinates

### Ordering Information

Specification	Description
A02B-0323-J727	30i-B 3-Dimensional Tool Compensation
A02B-0326-J727	31i-B5 3-Dimensional Tool Compensation
A02B-0327-J727	31i-B 3-Dimensional Tool Compensation

# 373

## Tool Functions / Tool Compensation

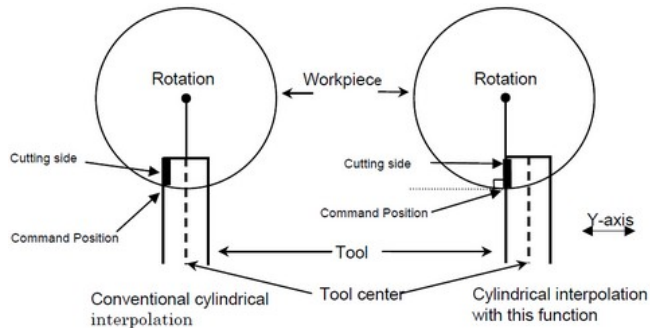

# Cutting Point Interpolation for Cylindrical Interpolation

## Features

The Cutting Point Interpolation function for Cylindrical Interpolation provides an easy use of the cutter compensation when performing cylindrical interpolation.

The conventional cylindrical interpolation function controls the tool center so that the tool axis always moves along a specified path on the cylindrical surface, towards the rotary axis (cylindrical axis) of the workpiece. The Cutting Point Interpolation for Cylindrical Interpolation function controls the tool so that the tangent of the tool and the cutting surface of a contour always passes the rotation center of the workpiece. This means that the cutting surface of the contour is always perpendicular to the cylinder.

With this function, the figure on the cutting surface can always be kept constant regardless of the cutter compensation value of the tool used.

As shown on the picture the tool is controlled in the offset axis (Y- axis) direction that is perpendicular to the tool centre.

## Benefits

- Addition of cutting capabilities for cylindrical shapes
- Simplification of the programming
- Improvement of the overall machining productivity

## Ordering Information

Specification	Description
A02B-0323-S674	30i-B Cutting Point Interpolation for Cylindrical Interpolation
A02B-0326-S674	31i-B5 Cutting Point Interpolation for Cylindrical Interpolation
A02B-0327-S674	31i-B Cutting Point Interpolation for Cylindrical Interpolation
A02B-0328-S674	32i-B Cutting Point Interpolation for Cylindrical Interpolation
A02B-0339-S674	0i-TF Cutting Point Interpolation for Cylindrical Interpolation
A02B-0340-S674	0i-MF Cutting Point Interpolation for Cylindrical Interpolation

### Notice

Certain functions may require additional hardware, different CPU type or additional memory capacity or may cause compatibility issue with other functions. In case of doubt, contact your FANUC sales representative for additional information and support.

The information given in the FANUC manuals or original manufacturer documentation shall prevail. Technical data is subject to change without prior notice. No part of this document may be reproduced in any form. All rights reserved. © FANUC 2017

# 374

## Tool Functions / Tool Compensation

# Tool Geometry/Wear Compensation

## Features

The Tool Geometry / Wear Compensation function changes the tool compensation memory configuration depending on whether the tool geometry and wear compensation functions are provided or not.

The following data items in tool compensation memory are affected:

- X- and Z-axis compensation values in tool offset
- Compensation value R when tool nose radius compensation is provided
- Y-axis compensation value when Y-axis offset is provided

When the tool geometry and wear compensation functions are not provided, there is no distinction between geometry compensation memory and wear compensation memory.

Therefore, a sum of the geometry compensation value and wear compensation value is set in compensation memory. When the tool geometry and wear compensation functions are provided, geometry compensation memory and wear compensation memory are prepared separately. In this case, geometry compensation values and wear compensation values can be set separately.

This function is a basic function in FANUC Series 0i-TF.

## Benefits

- Addition of compensation capabilities to the CNC
- Simplification of the programming
- Improvement of the overall machining productivity

## Ordering Information

Specification	Description
A02B-0323-J931	30i-B Tool Geometry and Wear Offset
A02B-0326-J931	31i-B5 Tool Geometry and Wear Offset
A02B-0327-J931	31i-B Tool Geometry and Wear Offset
A02B-0328-J931	32i-B Tool Geometry and Wear Offset

### Notice

Certain functions may require additional hardware, different CPU type or additional memory capacity or may cause compatibility issue with other functions. In case of doubt, contact your FANUC sales representative for additional information and support.

The information given in the FANUC manuals or original manufacturer documentation shall prevail. Technical data is subject to change without prior notice. No part of this document may be reproduced in any form. All rights reserved. © FANUC 2017

# 375

## Tool Functions / Tool Compensation

# 2nd Geometry Tool Offset

## Features

The 2nd Geometry Tool Offset function provides compensation for the difference in tool mounting position or in selected position; the second geometry tool offset can be provided in addition to tool offset.

Data that can be set for second geometry tool offset is the compensation values for the X-, Z-, and Y-axes.

## Benefits

- Addition of offset compensation
- Simplification of the programming
- Improvement of the overall machining productivity

## Ordering Information

Specification	Description
A02B-0323-J980	30i-B 2nd Geometry Tool Offset
A02B-0326-J980	31i-B5 2nd Geometry Tool Offset
A02B-0327-J980	31i-B 2nd Geometry Tool Offset
A02B-0328-J980	32i-B 2nd Geometry Tool Offset
A02B-0339-J980	0i-TF 2nd Geometry Tool Offset

### Notice

Certain functions may require additional hardware, different CPU type or additional memory capacity or may cause compatibility issue with other functions. In case of doubt, contact your FANUC sales representative for additional information and support.

The information given in the FANUC manuals or original manufacturer documentation shall prevail. Technical data is subject to change without prior notice. No part of this document may be reproduced in any form. All rights reserved. © FANUC 2017



# 376

## Tool Functions / Tool Compensation

# Tool Pairs for Tool Management Function

## Features

This function provides a framework and tables to manage machine tooling data. The tooling data table can be accessed through the PMC Window functions, C-Language Executor or via FOCAS / HSSB to a Panel i. When using this function, it is not necessary to develop an own machine-specific tool management HMI screens using C-Language Executor, Macro Executor, or PC-based high-level languages.

Data in the Tool Management table can be accessed by machine-specific tool change macros, read / write access through the main part program (G10 commands) and via manual data entry by the machine operator.

The Tool Management function is available in 3 different sizes:

- Tool Management Function - 64 pairs
- Tool Management Function - 240 pairs
- Tool Management Function - 1000 pairs.

## Benefits

- Custom tooling data HMI without using high level programming languages
- Management of tool life
- Sister tooling management (tool-type groups)
- Random or fixed tool-storage location.
- Customizable tool data management for Balluff ID, adaptive control, etc.

## Ordering Information

Specification	Description
A02B-0323-S830	30i-B Tool Management Function - 64 Tool Pairs
A02B-0323-S831	30i-B Tool Management Function - 240 Tool Pairs
A02B-0323-S833	30i-B Tool Management Function - 1000 Tool Pairs
A02B-0326-S830	31i-B5 Tool Management Function - 64 Tools Pairs
A02B-0326-S831	31i-B5 Tool Management Function - 240 Tool Pairs
A02B-0326-S833	31i-B5 Tool Management Function - 1000 Tool Pairs
A02B-0327-S830	31i-B Tool Management Function - 64 Tool Pairs
A02B-0327-S831	31i-B Tool Management Function - 240 Tool Pairs
A02B-0327-S833	31i-B Tool Management Function - 1000 Tool Pairs
A02B-0328-S830	32i-B Tool Management Function - 64 Tool Pairs
A02B-0328-S831	32i-B Tool Management Function - 240 Tool Pairs
A02B-0328-S833	32i-B Tool Management Function - 1000 Tool Pairs

### Notice

Certain functions may require additional hardware, different CPU type or additional memory capacity or may cause compatibility issue with other functions. In case of doubt, contact your FANUC sales representative for additional information and support.

The information given in the FANUC manuals or original manufacturer documentation shall prevail. Technical data is subject to change without prior notice. No part of this document may be reproduced in any form. All rights reserved. © FANUC 2017

# 377

Specification	Description
A02B-0339-S830	0i-TF Tool Management Function: 64 Pairs
A02B-0339-S831	0i-TF Tool Management Function: 240 Pairs
A02B-0339-S833	0i-TF Tool Management Function: 1000 Pairs
A02B-0340-S830	0i-MF Tool Management Function: 64 Pairs
A02B-0340-S831	0i-MF Tool Management Function: 240 Pairs
A02B-0340-S833	0i-MF Tool Management Function: 1000 Pairs

## Notice

Certain functions may require additional hardware, different CPU type or additional memory capacity or may cause compatibility issue with other functions. In case of doubt, contact your FANUC sales representative for additional information and support.

The information given in the FANUC manuals or original manufacturer documentation shall prevail. Technical data is subject to change without prior notice. No part of this document may be reproduced in any form. All rights reserved. © FANUC 2017

# 378

## Tool Functions / Tool Compensation

# Customized Data Expansion

## Features

This function provides 16 (or 36) additional customizable data columns for the Tool Management option. The data is located in columns 5 through 20 (or 5 through 40).

## Benefits

- Custom tooling data HMI without using high level programming languages
- Customizable tool data management for Balluff ID, adaptive control, etc
- Greater flexibility for machine-specific 'Tool Management' customization
- Enhanced tool data presentation.

## Ordering Information

Specification	Description
A02B-0323-S834	30i-B Tool Management Function - Customized Data Expansion (5 - 20)
A02B-0323-S835	30i-B Tool Management Function - Customized Data Expansion (5 - 40)
A02B-0326-S834	31i-B5 Tool Management Function - Customized Data Expansion (5 - 20)
A02B-0326-S835	31i-B5 Tool Management Function - Customized Data Expansion (5 - 40)
A02B-0327-S834	31i-B Tool Management Function - Customized Data Expansion (5 - 20)
A02B-0327-S835	31i-B Tool Management Function - Customized Data Expansion (5 - 40)
A02B-0328-S834	32i-B Tool Management Function - Customized Data Expansion (5 - 20)
A02B-0328-S835	32i-B Tool Management Function - Customized Data Expansion (5 - 40)
A02B-0339-S834	0i-TF Tool Management Function: Custom. Data Expansion (5-20)
A02B-0339-S835	0i-TF Tool Management Function: Custom. Data Expansion (5-40)
A02B-0340-S834	0i-MF Tool Management Function: Custom. Data Expansion (5-20)
A02B-0340-S835	0i-MF Tool Management Function: Custom. Data Expansion (5-40)

### Notice

Certain functions may require additional hardware, different CPU type or additional memory capacity or may cause compatibility issue with other functions. In case of doubt, contact your FANUC sales representative for additional information and support.

The information given in the FANUC manuals or original manufacturer documentation shall prevail. Technical data is subject to change without prior notice. No part of this document may be reproduced in any form. All rights reserved. © FANUC 2017

# 379

## Tool Functions / Tool Compensation

# Tool Management Expansion

## Features

The Tool Management Expansion function provides the following enhancements to the Tool Management Function:

- Customization of a tool management data item display
- Setting of the name of the spindle position and the wait position
- Setting of the customizing data with a decimal point
- Protection of a various tool management data by the key signal
- Selecting of the life counting cycle of tool life value
- Individual / each tool data screen
- Total life time display for tools of the same type<sup>1)</sup>
- Output to external device<sup>2)</sup>

1) Series 30i, 31i, 32i CNC only

2) Standard on Series 30i/31i/32i CNC

## Benefits

- Greater flexibility for machine-specific Tool Management customization
- Enhanced tool data presentation

## Ordering Information

Specification	Description
A02B-0323-S852	30i-B Tool Management Function - Tool Management Expansion
A02B-0326-S852	31i-B5 Tool Management Function - Tool Management Expansion
A02B-0327-S852	31i-B Tool Management Function - Tool Management Expansion
A02B-0328-S852	32i-B Tool Management Function - Tool Management Expansion
A02B-0339-S852	0i-TF Tool Management Expansion
A02B-0340-S852	0i-MF Tool Management Expansion

### Notice

Certain functions may require additional hardware, different CPU type or additional memory capacity or may cause compatibility issue with other functions. In case of doubt, contact your FANUC sales representative for additional information and support.

The information given in the FANUC manuals or original manufacturer documentation shall prevail. Technical data is subject to change without prior notice. No part of this document may be reproduced in any form. All rights reserved. © FANUC 2017

# 380

## Tool Functions / Tool Compensation

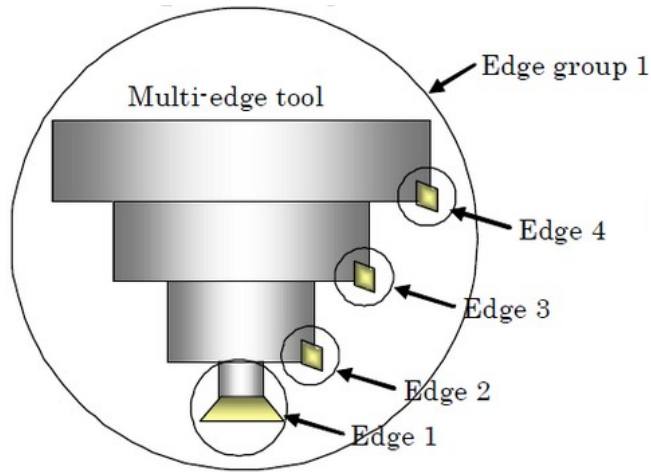

# Tool Management Function for Multi-Edge Tools

## Features

When using the Tool Management Function for Multi-Edge Tools to machine parts with a multi-edge tools (tools which has more than one edge), the tool life management is carried out for individual edges separately.

Unlike the conventional tool management function, which assigns an individual tool management data item to each tool, the multi-edge tool management function assigns an individual tool management data item to each edge.

## Benefits

- Simplifies the management of multi-edge tools on complex machining centers
- Increase of the flexibility of the tool changer
- Simplification of the programming of the tool changer handling

## Ordering Information

Specification	Description
A02B-0323-R681	30i-B Tool Management Function - Multi-Edge Tools
A02B-0326-R681	31i-B5 Tool Management Function - Multi-Edge Tools
A02B-0327-R681	31i-B Tool Management Function - Multi-Edge Tools
A02B-0328-R681	32i-B Tool Management Function - Multi-Edge Tools
A02B-0339-R681	0i-TF Tool Management Function for Multi-Edge Tools
A02B-0340-R681	0i-MF Tool Management Function for Multi-Edge Tools

### Notice

Certain functions may require additional hardware, different CPU type or additional memory capacity or may cause compatibility issue with other functions. In case of doubt, contact your FANUC sales representative for additional information and support.

The information given in the FANUC manuals or original manufacturer documentation shall prevail. Technical data is subject to change without prior notice. No part of this document may be reproduced in any form. All rights reserved. © FANUC 2017

# 381

## Tool Functions / Tool Compensation

# Tool Attachment/Detachment Management Function

## Features

The Tool Attachment / Detachment Management function enables the machine operator to load a tool and enter tool management data, all in one operation.

The tool will be registered to the empty magazine pocket selected, and the keyed-in Tool Data will be automatically entered into the Tool Management Data Table. Tool Attachment / Detachment is used in conjunction with the basic Tool Management Function and one of the optional Tool Management Function Pair features must also be activated.

Basic operation of the Tool Management Function requires that the Tool Type and Tool Data be defined in the Tool Management Table first before the tool can be assigned to the machine's spindle or tool magazine pocket. This is not always convenient for tool loading operations. Tool Attachment / Detachment allows the Machine Tool Builder / System Integrator to develop improved Tool Loading and Unloading procedures for enhanced end-user operation.

## Benefits

- Register / Delete a tool to / from the Magazine Management and Tool Management Tables simultaneously in one operation
- Automatic Attachment / Detachment operation enables the creation of Load / Unload cycles for automatic handling of tool to and from the magazine pocket

## Ordering Information

Specification	Description
A02B-0323-S997	30i-B Tool Management Function - Tool Attach / Detach Function
A02B-0326-S997	31i-B5 Tool Management Function - Tool Attach / Detach Function
A02B-0327-S997	31i-B Tool Management Function - Tool Attach / Detach Function
A02B-0328-S997	32i-B Tool Management Function - Tool Attach / Detach Function
A02B-0339-S997	0i-TF Tool Attachment / Detachment Management Function
A02B-0340-S997	0i-MF Tool Attachment / Detachment Management Function

### Notice

Certain functions may require additional hardware, different CPU type or additional memory capacity or may cause compatibility issue with other functions. In case of doubt, contact your FANUC sales representative for additional information and support.

The information given in the FANUC manuals or original manufacturer documentation shall prevail. Technical data is subject to change without prior notice. No part of this document may be reproduced in any form. All rights reserved. © FANUC 2017

# 382

## Tool Functions / Tool Compensation

# Tool Management Expansion B

## Features

The Tool Management Expansion B function provides the following enhancements to the Tool Management Function:

- Cartridge management data protection function
- Tool management data extraction function
- Tool management function magazine property / pot property
- Tool return function

## Benefits

- Increase of the flexibility to manage custom Tool Management systems

## Ordering Information

Specification	Description
A02B-0323-R616	30i-B Tool Management Function - Tool Management Expansion B
A02B-0326-R616	31i-B5 Tool Management Function - Tool Management Expansion B
A02B-0327-R616	31i-B Tool Management Function - Tool Management Expansion B
A02B-0328-R616	32i-B Tool Management Function - Tool Management Expansion B
A02B-0339-R616	0i-TF Tool Management Expansion B
A02B-0340-R616	0i-MF Tool Management Expansion B

### Notice

Certain functions may require additional hardware, different CPU type or additional memory capacity or may cause compatibility issue with other functions. In case of doubt, contact your FANUC sales representative for additional information and support.

The information given in the FANUC manuals or original manufacturer documentation shall prevail. Technical data is subject to change without prior notice. No part of this document may be reproduced in any form. All rights reserved. © FANUC 2017

# 383

## Tool Functions / Tool Compensation

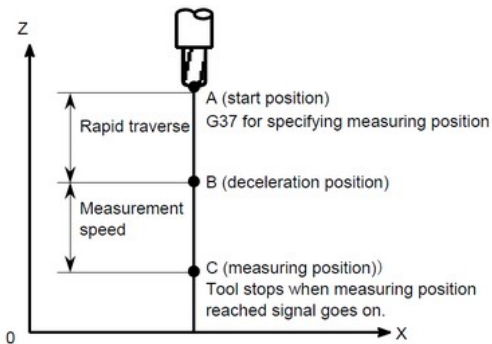

Compensation = (Current compensation) + [(Coordinate at tool stop) - (Coordinate at specification of measuring position)]

### Notice

Certain functions may require additional hardware, different CPU type or additional memory capacity or may cause compatibility issue with other functions. In case of doubt, contact your FANUC sales representative for additional information and support.

The information given in the FANUC manuals or original manufacturer documentation shall prevail. Technical data is subject to change without prior notice. No part of this document may be reproduced in any form. All rights reserved. © FANUC 2017

# Automatic Tool Length Measurement

## Features

The Automatic Tool Length Measurement function provides the capability to automatically measure tools. The difference between the coordinate value of tool when the tool end has reached the measuring position and coordinate value of the measuring position is automatically measured, calculated and added to the currently set tool offset amount by CNC system.

The machine must be equipped with measuring devices, for example touch probe, so that a signal is sent when the tool end has reached the measuring position.

The image shows an example of how the measuring position coordinate value is controlled.

When G37 is specified, the tool moves from the start point to the deceleration position by rapid traverse. Then, from the deceleration position, the tool decelerates to a parameter-set measurement federate and moves until the approach end signal is issued from the measuring device. The tool movement stops when the tool tip has reached the measurement position.

This function is a basic function in FANUC Series 0i-MF.

## Benefits

- Automation of the tool length measurement
- Simplification of the machine operation
- Improvement of the overall machining productivity

## Ordering Information

Specification	Description
A02B-0323-S618	30i-B Automatic Tool Length Measurement (CNC for Milling) / Automatic Tool Offset (CNC for Turning)
A02B-0326-S618	31i-B5 Automatic Tool Length Measurement (CNC for Milling) / Automatic Tool Offset (CNC for Turning)
A02B-0327-S618	31i-B Automatic Tool Length Measurement (CNC for Milling) / Automatic Tool Offset (CNC for Turning)
A02B-0328-S618	32i-B Automatic Tool Length Measurement (CNC for Milling) / Automatic Tool Offset (CNC for Turning)
A02B-0339-S618	0i-TF Automatic Tool Offset



# 384

## Tool Functions / Tool Compensation

# High-Speed Measuring Position Reach Signal Input

## Features

Measurement can be made using the high-speed measuring position reached signals HAE1 to HAE8 (connected directly to the CNC). This procedure is provided instead of the standard measuring position reached signals. Up to eight signal inputs can be used with the high-speed measuring position reached signals.

When using the standard function through the PMC, the delay and variation in detecting the input of a measuring position reached signal is 0 to 2 ms on the CNC side, excluding the PMC side.

A delay and variation in detecting the input of a high-speed measuring position reached signal can be reduced to 0.1 ms or lower, so that high-precision measurement can be made.

## Benefits

- Automation of the tool length measurement
- Simplification of the machine operation
- Improvement of the overall machining productivity

## Ordering Information

Specification	Description
A02B-0323-S998	30i-B High-Speed Measuring Position Reach Signal Input
A02B-0326-S998	31i-B5 High-Speed Measuring Position Reach Signal Input
A02B-0327-S998	31i-B High-Speed Measuring Position Reach Signal Input
A02B-0328-S998	32i-B High-Speed Measuring Position Reach Signal Input

### Notice

Certain functions may require additional hardware, different CPU type or additional memory capacity or may cause compatibility issue with other functions. In case of doubt, contact your FANUC sales representative for additional information and support.

The information given in the FANUC manuals or original manufacturer documentation shall prevail. Technical data is subject to change without prior notice. No part of this document may be reproduced in any form. All rights reserved. © FANUC 2017

# 385

## Tool Functions / Tool Compensation

# Tool Length / Work Zero Point Measurement

## Features

Tool Length /Work Zero Point Measurement function has been designed to simplify the procedure of tool length measurement.

This function facilitates the machining setup, resulting in a reduced machining setup time. The function eases the measurement of the workpiece origin offset. With this function, the operator can program a T / M code or a reference position return by specifying a manual numerical command on the tool length offset measurement screen.

## Benefits

- Automation of the tool length measurement
- Simplification of the machine operation
- Improvement of the overall machining productivity

## Ordering Information

Specification	Description
A02B-0323-J668	30i-B Tool Length / Work Zero Point Measurement
A02B-0326-J668	31i-B5 Tool Length / Work Zero Point Measurement
A02B-0327-J668	31i-B Tool Length / Work Zero Point Measurement
A02B-0328-J668	32i-B Tool Length/Work Zero Point Measurement

### Notice

Certain functions may require additional hardware, different CPU type or additional memory capacity or may cause compatibility issue with other functions. In case of doubt, contact your FANUC sales representative for additional information and support.

The information given in the FANUC manuals or original manufacturer documentation shall prevail. Technical data is subject to change without prior notice. No part of this document may be reproduced in any form. All rights reserved. © FANUC 2017

# 386

## Tool Functions / Tool Compensation

# Direct Input of Offset Value Measured B

## Features

The Direct Input of Offset Value Measured B function provides the capability to input offset values using a touch probe. Using the touch probe and by manually making the tool contact the touch probe, it is possible to set the offset amount of that tool automatically in the tool offset amount memory.

It is also possible to set the workpiece coordinate system shift amount automatically. The tool setter function for single-turret / two-spindle lathes is also available, which allows to use the direct input of the tool offset value measured B for each spindle in a single-turret / two-spindle lathe.

This function is a basic function in FANUC Series 0i-TF.

## Benefits

- Automation of the tool offset
- Simplification of the machine operation
- Improvement of the overall machining productivity

## Ordering Information

Specification	Description
A02B-0323-J933	30i-B Direct Input Value Measured B
A02B-0326-J933	31i-B5 Direct Input Value Measured B
A02B-0327-J933	31i-B Direct Input Value Measured B
A02B-0328-J933	32i-B Direct Input Value Measured B

### Notice

Certain functions may require additional hardware, different CPU type or additional memory capacity or may cause compatibility issue with other functions. In case of doubt, contact your FANUC sales representative for additional information and support.

The information given in the FANUC manuals or original manufacturer documentation shall prevail. Technical data is subject to change without prior notice. No part of this document may be reproduced in any form. All rights reserved. © FANUC 2017

# 387

## Tool Functions / Tool Compensation

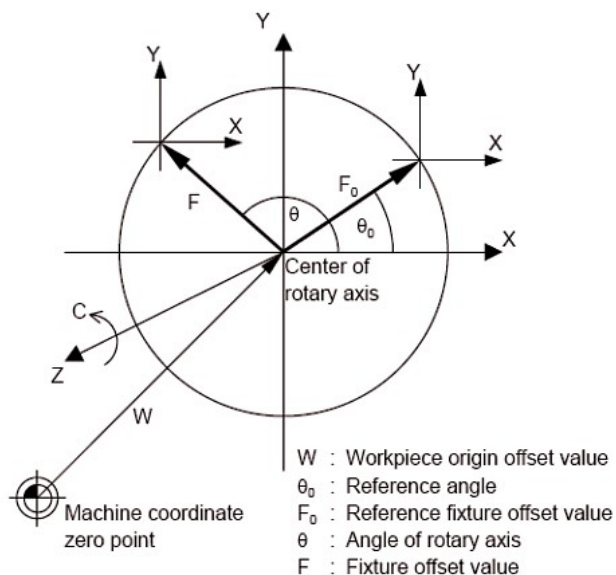

# Rotary Table Dynamic Fixture Offset

## Features

The Rotary Table Dynamic Fixture Offset function avoids for the operator to re-set the workpiece coordinate system whenever the rotary table rotates before cutting is started.

## Benefits

- Ability to adjust part location at the control level
- No need to repost programs if rotary axis is misaligned
- Ease of operation
- Reduce Setups

## Ordering Information

Specification	Description
A02B-0323-S728	30i-B Rotary Table Dynamic Fixture Offset
A02B-0326-S728	31i-B5 Rotary Table Dynamic Fixture Offset
A02B-0327-S728	31i-B Rotary Table Dynamic Fixture Offset
A02B-0328-S728	32i-B Rotary Table Dynamic Fixture Offset

### Notice

Certain functions may require additional hardware, different CPU type or additional memory capacity or may cause compatibility issue with other functions. In case of doubt, contact your FANUC sales representative for additional information and support.

The information given in the FANUC manuals or original manufacturer documentation shall prevail. Technical data is subject to change without prior notice. No part of this document may be reproduced in any form. All rights reserved. © FANUC 2017

# 388

## Tool Functions / Tool Compensation

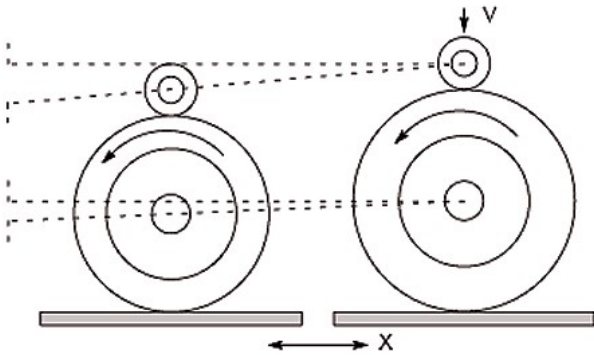

## Wheel Wear Compensation

### Features

The Wheel Wear Compensation function is used on grinding machines to compensate for wear of the wheel and dresser. The grinding-wheel and dresser are compensated continuously during grinding in the canned cycles for surface grinding (G75, and G77 to G79). They are compensated according to the amount of continuous dressing.

### Benefits

- Addition of compensation for grinding wheel
- Simplification of the programming
- Improvement of the overall machining productivity

### Ordering Information

Specification	Description
A02B-0323-J633	30i-B Wheel Wear Compensation
A02B-0326-J633	31i-B5 Wheel Wear Compensation
A02B-0327-J633	31i-B Wheel Wear Compensation
A02B-0328-J633	32i-B Wheel Wear Compensation

#### Notice

Certain functions may require additional hardware, different CPU type or additional memory capacity or may cause compatibility issue with other functions. In case of doubt, contact your FANUC sales representative for additional information and support.

The information given in the FANUC manuals or original manufacturer documentation shall prevail. Technical data is subject to change without prior notice. No part of this document may be reproduced in any form. All rights reserved. © FANUC 2017

# 389

## Tool Functions / Tool Compensation

# Changing Active Offset Value with Manual Move

## Features

When rough machining or semi-finishing need to be performed using a single tool, it is possible to make a fine adjustment of a tool length compensation value or cutter compensation value.

During setup, it is also desirable to make a fine adjustment of a workpiece origin offset once set.

With this function, a travel distance moved on an axis by manual feed is automatically added to the workpiece coordinate system or the currently valid offset number among the specified offset values (tool length compensation value / cutter compensation value / workpiece origin offset) to make a offset value change.

## Benefits

- On the fly adjustment of offset during rough machining or semi-finishing
- Simplification of the programming
- Improvement of the overall machining productivity

## Ordering Information

Specification	Description
A02B-0323-S825	30i-B Changing Active Offset Value with Manual Move
A02B-0326-S825	31i-B5 Changing Active Offset Value with Manual Move
A02B-0327-S825	31i-B Changing Active Offset Value with Manual Move
A02B-0328-S825	32i-B Changing Active Offset Value with Manual Move

### Notice

Certain functions may require additional hardware, different CPU type or additional memory capacity or may cause compatibility issue with other functions. In case of doubt, contact your FANUC sales representative for additional information and support.

The information given in the FANUC manuals or original manufacturer documentation shall prevail. Technical data is subject to change without prior notice. No part of this document may be reproduced in any form. All rights reserved. © FANUC 2017

# 390

## Tool Functions / Tool Compensation

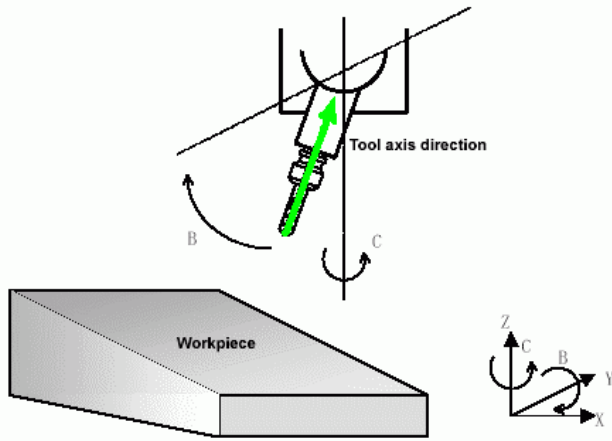

### Notice

Certain functions may require additional hardware, different CPU type or additional memory capacity or may cause compatibility issue with other functions. In case of doubt, contact your FANUC sales representative for additional information and support.

The information given in the FANUC manuals or original manufacturer documentation shall prevail. Technical data is subject to change without prior notice. No part of this document may be reproduced in any form. All rights reserved. © FANUC 2017

## Tool Length Compensation in Tool Axis Direction

### Features

On a five-axis machine, when two axes are used to rotate the tool, the tool length compensation can be performed in a specified tool axis direction on a rotation axis.

When a rotation axis is specified in tool axis direction tool length compensation mode, the tool length compensation is applied in a specified tool axis direction on the rotation axis by the compensation value specified in the H code.

As a consequence, the movement is made along the three linear axes (Xp, Yp, Zp).

### Benefits

- Addition of tool compensation function on a 5-axis machine
- Simplification of the programming
- Improvement of the overall machining productivity

### Ordering Information

Specification	Description
A02B-0323-S670	30i-B Tool Length Compensation in Tool Axis Direction
A02B-0326-S670	31i-B5 Tool Length Compensation in Tool Axis Direction

# 391

## Tool Functions / Tool Compensation

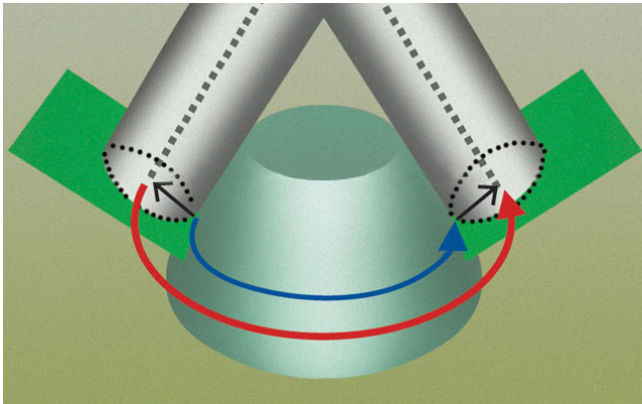

## 3-Dimensional Cutter Compensation

### Features

The 3-Dimensional Cutter Compensation function, formerly called Tool Radius Compensation for 5 Axis Machining, supports part programming of surface coordinates of full 5-Axes complex contours.

It allows the definition of the diameter of the tool at the control level rather than compensating for the tool radius in the part-program.

For machines having multiple rotary axes to freely control the orientation of a tool axis, this function calculates a tool vector from the positions of these rotary axes. This function then calculates a compensation vector in a plane perpendicular to the tool vector and applies three-dimensional cutter offset. This allows for full 5-Axes surface coordinate contouring of complex parts and for any adjustment of the tooling diameter to be maintained at the control level.

### Benefits

- Usage of different tool cutter radius for side cutting in 5-axis machining
- Higher machining flexibility
- Machining of complex 5-axis parts (e.g. pyramids and cones)
- Ability to adjust the tool diameter at the control
- Ability to offset part using machine work piece offsets
- Part Programming versus machine programming
- Program is easily transferable to similar machines
- No need to repost programs when tool diameter changes
- Saves on tooling costs. Easily use reground tooling

### Ordering Information

Specification	Description
A02B-0323-S667	30i-B 3-Dimensional Cutter Compensation
A02B-0326-S667	31i-B5 3-Dimensional Cutter Compensation
A02B-0327-S667	31i-B 3-Dimensional Cutter Compensation

#### Notice

Certain functions may require additional hardware, different CPU type or additional memory capacity or may cause compatibility issue with other functions. In case of doubt, contact your FANUC sales representative for additional information and support.

The information given in the FANUC manuals or original manufacturer documentation shall prevail. Technical data is subject to change without prior notice. No part of this document may be reproduced in any form. All rights reserved. © FANUC 2017



# 392

## Tool Functions / Tool Compensation

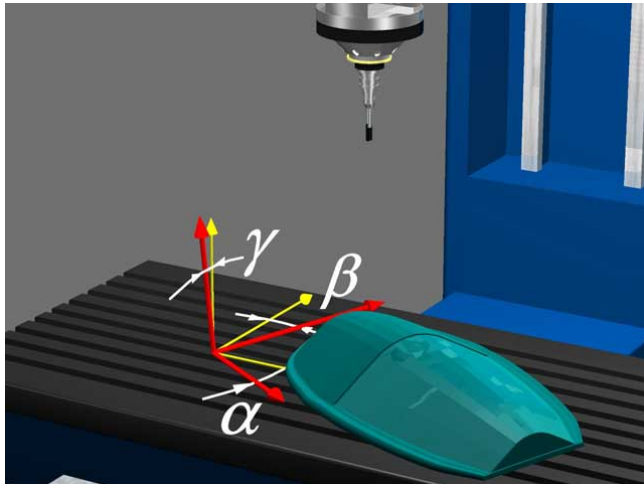

# Workpiece Setting Error Compensation

## Features

With large workpieces, it is often the case that a workpiece is clamped for the first or second machining stage and is then, perhaps, removed for measurement.

It must then be re-clamped before machining is continued and position errors are unavoidable. The Workpiece Setting Error Compensation feature detects this through measuring cycles that determine the error and automatically corrects prior to initiating the standard part program.

## Benefits

- Shortens set-up time
- More efficient production process
- Better quality
- Avoiding potential operators errors

## Ordering Information

Specification	Description
A02B-0323-S993	30i-B Workpiece Setting Error Compensation
A02B-0326-S993	31i-B5 Workpiece Setting Error Compensation
A02B-0327-S993	31i-B Workpiece Setting Error Compensation
A02B-0328-S993	32i-B Workpiece Setting Error Compensation

### Notice

Certain functions may require additional hardware, different CPU type or additional memory capacity or may cause compatibility issue with other functions. In case of doubt, contact your FANUC sales representative for additional information and support.

The information given in the FANUC manuals or original manufacturer documentation shall prevail. Technical data is subject to change without prior notice. No part of this document may be reproduced in any form. All rights reserved. © FANUC 2017

# 393

## Tool Functions / Tool Compensation

# Direct Input of Offset Value Measured B for 2-Spindle Lathe

## Features

In lathe with two touch sensors, each tool offset and workpiece origin offset for two workpiece coordinate systems can be automatically calculated. The lathe, which has a back spindle, has a different workpiece coordinate system for each spindle.

## Benefits

- For 2 workpiece coordinate system, each tool offset and workpiece origin offset can be automatically calculated

## Ordering Information

Specification	Description
A02B-0323-J686	30i-B Direct Input of Offset Value Measured B for 2 Spindle Lathe
A02B-0326-J686	31i-B5 Direct Input of Offset Value Measured B for 2 Spindle Lathe
A02B-0327-J686	31i-B Direct Input of Offset Value Measured B for 2 Spindle Lathe
A02B-0328-J686	32i-B Direct Input of Offset Value Measured B for 2 Spindle Lathe
A02B-0339-J686	0i-TF Direct input of Offset Value Measured B for 2 Spindle Lathe

### Notice

Certain functions may require additional hardware, different CPU type or additional memory capacity or may cause compatibility issue with other functions. In case of doubt, contact your FANUC sales representative for additional information and support.

The information given in the FANUC manuals or original manufacturer documentation shall prevail. Technical data is subject to change without prior notice. No part of this document may be reproduced in any form. All rights reserved. © FANUC 2017

# 394

## Tool Functions / Tool Compensation

# Tool Life Management

## Features

When the usage of a tool exceeds the preset hours or times of use, another tool in the same group which has not yet exceeded the preset lifetime is selected.

This function is a basic function in FANUC Series 0i-MF and 0i-TF.

## Benefits

- Improvement of the tool group management
- Optimization of the machine and tool usage
- Automatic alarm generated
- Automation for mass production

## Ordering Information

Specification	Description
A02B-0323-J935	30i-B Tool Life Management
A02B-0323-J936	30i-B Tool Life Management - Addition of Tool Pairs
A02B-0326-J935	31i-B5 Tool Life Management
A02B-0326-J936	31i-B5 Tool Life Management - Addition of Tool Pairs
A02B-0327-J935	31i-B Tool Life Management
A02B-0327-J936	31i-B Tool Life Management - Addition of Tool Pairs
A02B-0328-J935	32i-B Tool Life Management
A02B-0328-J936	32i-B Tool Life Management - Addition of Tool Pairs

### Notice

Certain functions may require additional hardware, different CPU type or additional memory capacity or may cause compatibility issue with other functions. In case of doubt, contact your FANUC sales representative for additional information and support.

The information given in the FANUC manuals or original manufacturer documentation shall prevail. Technical data is subject to change without prior notice. No part of this document may be reproduced in any form. All rights reserved. © FANUC 2017

# 395

## Tool Functions / Tool Compensation

# Spindle Unit Compensation

---

## Features

For a machine with multiple spindle units, the characteristic parameters, compensation amounts etc. can be set for each unit respectively. By compensating a selected unit during machining, it is possible to create programs that are not influenced by spindle unit compensation amounts.

If a spindle unit is controlled as a rotational axis, the compensation amount is calculated from the rotation angle automatically.

## Benefits

- Simplifies programming

## Ordering Information

Specification	Description
A02B-0323-R620	30i-B Spindle Unit Compensation
A02B-0326-R620	31i-B5 Spindle Unit Compensation
A02B-0327-R620	31i-B Spindle Unit Compensation

### Notice

Certain functions may require additional hardware, different CPU type or additional memory capacity or may cause compatibility issue with other functions. In case of doubt, contact your FANUC sales representative for additional information and support.

The information given in the FANUC manuals or original manufacturer documentation shall prevail. Technical data is subject to change without prior notice. No part of this document may be reproduced in any form. All rights reserved. © FANUC 2017

# 396

## Tool Functions / Tool Compensation

# Nutating Rotary Head Tool Length Compensation

## Features

For a machine with multiple spindle units, the characteristic parameters, tool axis directions etc. can be set for each unit respectively. By compensating a selected unit during machining, it is possible to create programs that are not influenced by tool length compensation amounts.

If a spindle unit is controlled as a rotational axis, the compensation amount is calculated from the rotation angle automatically.

## Benefits

- Simplifies programming

## Ordering Information

Specification	Description
A02B-0323-R628	30i-B Nutating Rotary Head Tool Length Compensation
A02B-0326-R628	31i-B5 Nutating Rotary Head Tool Length Compensation
A02B-0327-R628	31i-B Nutating Rotary Head Tool Length Compensation

### Notice

Certain functions may require additional hardware, different CPU type or additional memory capacity or may cause compatibility issue with other functions. In case of doubt, contact your FANUC sales representative for additional information and support.

The information given in the FANUC manuals or original manufacturer documentation shall prevail. Technical data is subject to change without prior notice. No part of this document may be reproduced in any form. All rights reserved. © FANUC 2017

# 397

## Tool Functions / Tool Compensation

# Automatic Alteration of Tool Position Compensation

## Features

The Automatic Alteration of Tool Position Compensation function is used to select a new tool number by an external signal from the PMC in manual operation mode.

When a tool is changed manually, the tool offset value (Tool geometry/wear compensation) can be adjusted to the selected tool by specifying the new tool number with an external signal through the PMC.

## Benefits

- Increase of the manual tool management capabilities
- Simplification of the programming
- Improvement of the overall machining productivity

## Ordering Information

Specification	Description
A02B-0323-J690	30i-B Automatic Alteration of Tool Position Compensation
A02B-0326-J690	31i-B5 Automatic Alteration of Tool Position Compensation
A02B-0327-J690	31i-B Automatic Alteration of Tool Position Compensation
A02B-0328-J690	32i-B Automatic Alteration of Tool Position Compensation
A02B-0339-J690	0i-TF Automatic Alteration of Tool Position Compensation

### Notice

Certain functions may require additional hardware, different CPU type or additional memory capacity or may cause compatibility issue with other functions. In case of doubt, contact your FANUC sales representative for additional information and support.

The information given in the FANUC manuals or original manufacturer documentation shall prevail. Technical data is subject to change without prior notice. No part of this document may be reproduced in any form. All rights reserved. © FANUC 2017

# 398

## Tool Functions / Tool Compensation

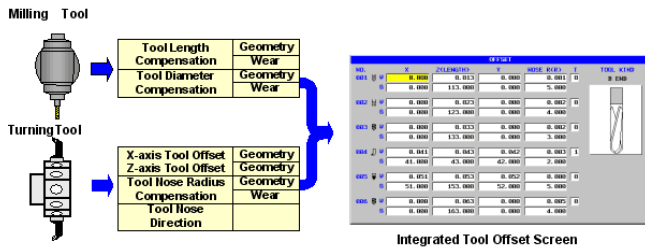

### Notice

Certain functions may require additional hardware, different CPU type or additional memory capacity or may cause compatibility issue with other functions. In case of doubt, contact your FANUC sales representative for additional information and support.

The information given in the FANUC manuals or original manufacturer documentation shall prevail. Technical data is subject to change without prior notice. No part of this document may be reproduced in any form. All rights reserved. © FANUC 2017

# Tool Offset for Milling and Turning Function

## Features

The Tool Offset Screen for Compound Machine function has been designed to meet the requirements of compound machine tools to manage both offset data of milling and turning tools on one offset screen, which simplifies the tool offset data management of compound machines.

Features:

- Manages and displays offset data of both milling and turning tools on an Integrated Tool Offset Screen
- Manages and displays geometry and wear compensation data on an Integrated Tool Offset Screen
- Displays tool shape in graphic for easy operation. Designates tool shape on the dedicated screen

## Limitation

The following functions cannot be used with this function:

- Tool position offset (G45~G48)
- Tool position offset B
- Changing Active Offset Value with Manual Move
- Basic operation package 2
- Manual Guide i
- Tool offset data cannot be protected by '8-level data protection function'

## Benefits

- Addition of tool management capabilities for compound machines
- Simplification of the setup and tool management
- Improvement of the overall machining productivity

## Ordering Information

Specification	Description
A02B-0323-R595	30i-B Tool Offset for Milling and Turning Function
A02B-0326-R595	31i-B5 Tool Offset for Milling and Turning Function
A02B-0327-R595	31i-B Tool Offset for Milling and Turning Function
A02B-0328-R595	32i-B Tool Offset for Milling and Turning Function
A02B-0339-R595	0i-TF Tool Offset for Milling and Turning Function

# 399

## Tool Functions / Tool Compensation

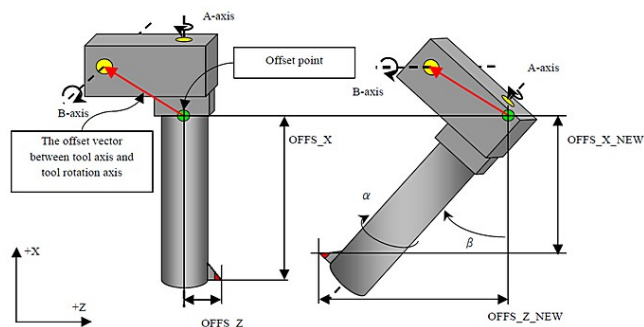

## Tool Offset Conversion Function

### Features

On a complicated machine composition that has rotation axes (see illustration), the tool offset of each axis and the direction of imaginary tool nose are changed by angle of rotation degree of the tool nose rotation axis and the swivel head axis.

It is assumed that the direction of the tool nose rotation axis is X(A-axis) and the direction of the swivel head axis is Y(B-axis) in X-Z plane.

In this function, the tool offset and the direction of imaginary tool nose (which are measured and are set to the tool offset screen when A and B are set to 0 degree) are converted into appropriate value which depends on the angle of the rotation axis (A and B) by the G44.1 command. The commanded angle of A-axis must be selected from 0 or 180 degree.

### Benefits

- Benefit list not available

### Ordering Information

Specification	Description
A02B-0323-R691	30i-B Tool Offset Conversion Function
A02B-0326-R691	31i-B5 Tool Offset Conversion Function
A02B-0327-R691	31i-B Tool Offset Conversion Function
A02B-0328-R691	32i-B Tool Offset Conversion Function

### Notice

Certain functions may require additional hardware, different CPU type or additional memory capacity or may cause compatibility issue with other functions. In case of doubt, contact your FANUC sales representative for additional information and support.

The information given in the FANUC manuals or original manufacturer documentation shall prevail. Technical data is subject to change without prior notice. No part of this document may be reproduced in any form. All rights reserved. © FANUC 2017



# 400

## Tool Functions / Tool Compensation

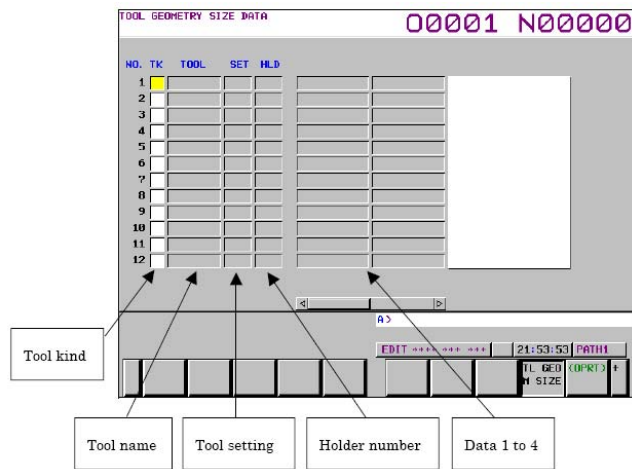

## Tool Geometry Size Data

### Features

The tool geometry size data can be set through a special input screen (Tool geometry size data setting screen) under the tool management screen.

The tool geometry size data stores tool data like shape and size etc. to be used in the 3D interference check function and dynamic graphic display function. It also applies to the simulation functionality of MANUAL GUIDE i.

### Benefits

- Addition of capabilities for the Tool Management function
- Simplification of the programming
- Improvement of the overall machining productivity

### Ordering Information

Specification	Description
A02B-0323-R589	30i-B Tool Geometry Size Data, 100 Pairs
A02B-0323-R590	30i-B Tool Geometry Size Data, 300 Pairs
A02B-0326-R362	31i-B5 Tool Geometry Size Data, 1000 Pairs
A02B-0326-R589	31i-B5 Tool Geometry Size Data, 100 Pairs
A02B-0326-R590	31i-B5 Tool Geometry Size Data, 300 Pairs
A02B-0327-R362	31i-B Tool Geometry Size Data, 1000 Pairs
A02B-0327-R589	31i-B Tool Geometry Size Data, 100 Pairs
A02B-0327-R590	31i-B Tool Geometry Size Data, 300 Pairs
A02B-0328-R362	32i-B Tool Geometry Size Data, 1000 Pairs
A02B-0328-R589	32i-B Tool Geometry Size Data, 100 Pairs
A02B-0328-R590	32i-B Tool Geometry Size Data, 300 Pairs
A02B-0339-R589	0i-TF Tool Geometry Size Data: 100 Pairs
A02B-0339-R590	0i-TF Tool Geometry Size Data, 300 Pairs
A02B-0340-R589	0i-MF Tool Geometry Size Data: 100 PAIRS
A02B-0340-R590	0i-MF Tool Geometry Size Data, 300 Pairs

### Notice

Certain functions may require additional hardware, different CPU type or additional memory capacity or may cause compatibility issue with other functions. In case of doubt, contact your FANUC sales representative for additional information and support.

The information given in the FANUC manuals or original manufacturer documentation shall prevail. Technical data is subject to change without prior notice. No part of this document may be reproduced in any form. All rights reserved. © FANUC 2017

# 401

## Tool Functions / Tool Compensation

NO.	TYPE NO.	MG	POT	TK	TOOL	SET	HLD	CUT AN	NOS AN
1	1111	1	1	1	GENERAL	8	1	100.000	60.000
2	2222	1	6	0	THREAD	6	1	40.000	26.000
3	3333	1	3	0	GROVE	4	2	32.500	67.000
4	4444	1	16	0	BUTTON	12	2	35.000	
5	0	0	0	0					
6	0	0	0	0					
7	0	0	0	0					
8	0	0	0	0					
9	0	0	0	0					
10	0	0	0	0					
11	0	0	0	0					
12	0	0	0	0					

## Tool Geometry Size Data - Additional Tool Type

### Features

This function supports to use the tool kind for the lathe system even if it is used in the machining center type path.

As a result, when the compound machining is executed in the machining center type path, the tool geometry size data can be used for it.

### Benefits

- Simplifies the management of tools for compound machines

### Ordering Information

Specification	Description
A02B-0323-R685	30i-B Addition of Tool Kind in Tool Geometry Size Data
A02B-0326-R685	31i-B5 Addition of Tool Kind in Tool Geometry Size Data
A02B-0327-R685	31i-B Addition of Tool Kind in Tool Geometry Size Data
A02B-0328-R685	32i-B Addition of Tool Kind in Tool Geometry Size Data
A02B-0339-R685	0i-TF Addition of Tool Geometry Size Data
A02B-0340-R685	0i-MF Addition of Tool Geometry Size Data

### Notice

Certain functions may require additional hardware, different CPU type or additional memory capacity or may cause compatibility issue with other functions. In case of doubt, contact your FANUC sales representative for additional information and support.

The information given in the FANUC manuals or original manufacturer documentation shall prevail. Technical data is subject to change without prior notice. No part of this document may be reproduced in any form. All rights reserved. © FANUC 2017

# 402

## Functions

# Accuracy Compensation Functions

---

Machine Compensation Functions are options that allow the CNC to compensate for mechanical inaccuracies in the machine.

Some of the functions detailed in the catalogue:

- Backlash compensation
- Pitch error compensation
- Inclination compensation
- Straightness compensation
- 3 dimensional error compensation
- 3 dimensional machine compensation
- Etc.

### Notice

Certain functions may require additional hardware, different CPU type or additional memory capacity or may cause compatibility issue with other functions. In case of doubt, contact your FANUC sales representative for additional information and support.

The information given in the FANUC manuals or original manufacturer documentation shall prevail. Technical data is subject to change without prior notice. No part of this document may be reproduced in any form. All rights reserved. © FANUC 2017

# 403

## Accuracy Compensation Functions

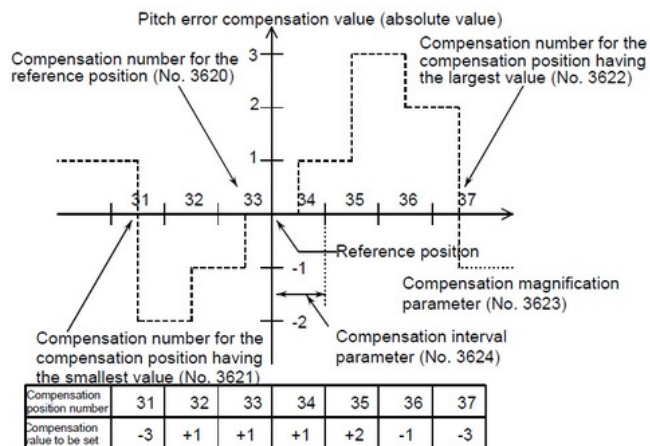

### Notice

Certain functions may require additional hardware, different CPU type or additional memory capacity or may cause compatibility issue with other functions. In case of doubt, contact your FANUC sales representative for additional information and support.

The information given in the FANUC manuals or original manufacturer documentation shall prevail. Technical data is subject to change without prior notice. No part of this document may be reproduced in any form. All rights reserved. © FANUC 2017

# Stored Pitch Error Compensation

## Features

The Pitch Error Compensation function is used to compensate for error in the ball screw. A total number of compensation points for the system are arbitrarily divided among the axes. The compensation amount, in detection units, is subject to a multiplier.

The pitch error compensation pulse at each pitch error compensation point is output in the interval between that point and the next compensation point, as shown in the figure.

## Benefits

- Improvement of machine precision
- Increase of production quality and overall machine productivity

## Ordering Information

Specification	Description
A02B-0323-J841	30i-B Pitch Error Compensation
A02B-0326-J841	31i-B5 Pitch Error Compensation
A02B-0327-J841	31i-B Pitch Error Compensation
A02B-0328-J841	32i-B Pitch Error Compensation
A02B-0339-J841	0i-TF Stored Pitch Error Compensation
A02B-0340-J841	0i-MF Stored Pitch Error Compensation

# 404

## Accuracy Compensation Functions

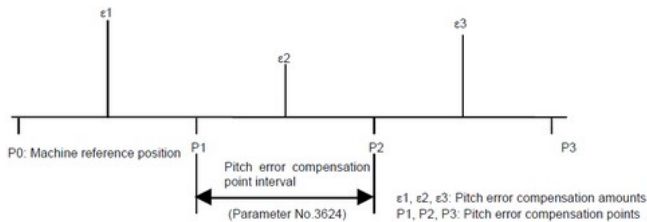

## Interpolation Type Pitch Error Compensation

### Features

The Interpolation Type Pitch Error Compensation function outputs divided compensation pulses between compensation points in such a way that a smoother pitch error compensation can be realized.

The compensation amount at each error compensation point is divided into pulses in the interval between that point and the next point on the travel axis and output, as shown in the figure.

The Stored Pitch Error Compensation function is required to be able to use this function, and can be used with Bi-Directional Pitch Error Compensation.

### Benefits

- Increase of the precision of the compensation
- Improvement of machine precision
- Increase of production quality and overall machine productivity

### Ordering Information

Specification	Description
A02B-0323-S644	30i-B Interpolation Type Pitch Error Compensation
A02B-0326-S644	31i-B5 Interpolation Type Pitch Error Compensation
A02B-0327-S644	31i-B Interpolation Type Pitch Error Compensation
A02B-0328-S644	32i-B Interpolation Type Pitch Error Compensation
A02B-0339-S644	0i-TF Interpolation Type Pitch Error Compensation
A02B-0340-S644	0i-MF Interpolation Type Pitch Error Compensation

#### Notice

Certain functions may require additional hardware, different CPU type or additional memory capacity or may cause compatibility issue with other functions. In case of doubt, contact your FANUC sales representative for additional information and support.

The information given in the FANUC manuals or original manufacturer documentation shall prevail. Technical data is subject to change without prior notice. No part of this document may be reproduced in any form. All rights reserved. © FANUC 2017

# 405

## Accuracy Compensation Functions

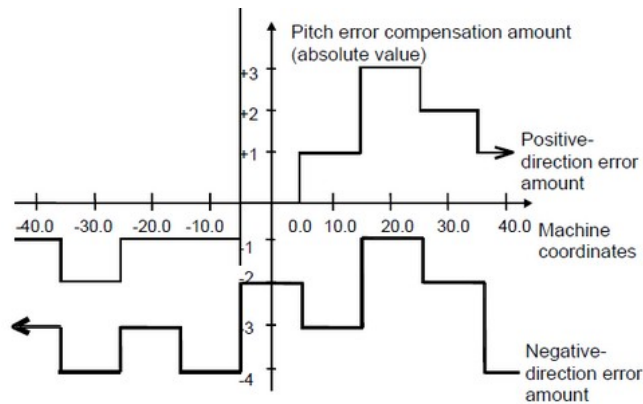

## Bi-Directional Pitch Error Compensation

### Features

The Bi-Directional Pitch Error Compensation function allows different pitch error compensation amounts to be set for travel in the positive direction and in the negative direction, so that pitch error compensation can be performed differently in the two directions.

The Stored Pitch Error Compensation function, as a comparison, does not distinguish between the directions of travel.

In addition, when the direction of travel is reversed, the compensation amount is automatically calculated from the pitch error compensation data to perform compensation in the same way as in backlash compensation. This reduces the difference between the paths in the positive and negative directions.

The total number of compensation points is 2048. It requires the option Stored Pitch Error Compensation.

### Benefits

- Compensation of the errors in 2 different directions
- Improvement of machine precision
- Increase of production quality and overall machine productivity

### Ordering Information

Specification	Description
A02B-0323-S656	30i-B Bi-Directional Pitch Error Compensation
A02B-0326-S656	31i-B5 Bi-Directional Pitch Error Compensation
A02B-0327-S656	31i-B Bi-Directional Pitch Error Compensation
A02B-0328-S656	32i-B Bi-Directional Pitch Error Compensation
A02B-0339-S656	0i-TF Bi-Directional Pitch Error Compensation
A02B-0340-S656	0i-MF Bi-Directional Pitch Error Compensation

#### Notice

Certain functions may require additional hardware, different CPU type or additional memory capacity or may cause compatibility issue with other functions. In case of doubt, contact your FANUC sales representative for additional information and support.

The information given in the FANUC manuals or original manufacturer documentation shall prevail. Technical data is subject to change without prior notice. No part of this document may be reproduced in any form. All rights reserved. © FANUC 2017

# 406

## Accuracy Compensation Functions

# Extended Bi-Directional Pitch Error Compensation

## Features

The Extended Bi-Directional Pitch Error Compensation function provides the same functionality as the Bi-Directional Pitch Error Compensation function, but increases the number of compensation points from 2048 to 5120.

It requires both Stored Pitch Error Compensation and Bi-Directional Pitch Error Compensation function activated in the CNC.

## Benefits

- Increase the precision of the compensation in 2 different directions
- Improvement of machine precision
- Increase of production quality and overall machine productivity

## Ordering Information

Specification	Description
A02B-0323-S657	30i-B Extended Bi-Directional Pitch Error Compensation
A02B-0326-S657	31i-B5 Extended Bi-Directional Pitch Error Compensation
A02B-0327-S657	31i-B Extended Bi-Directional Pitch Error Compensation
A02B-0328-S657	32i-B Extended Bi-Directional Pitch Error Compensation
A02B-0339-S657	0i-TF Extended Bi-Directional Pitch Error Compensation
A02B-0340-S657	0i-MF Extended Bi-Directional Pitch Error Compensation

### Notice

Certain functions may require additional hardware, different CPU type or additional memory capacity or may cause compatibility issue with other functions. In case of doubt, contact your FANUC sales representative for additional information and support.

The information given in the FANUC manuals or original manufacturer documentation shall prevail. Technical data is subject to change without prior notice. No part of this document may be reproduced in any form. All rights reserved. © FANUC 2017

# 407

## Accuracy Compensation Functions

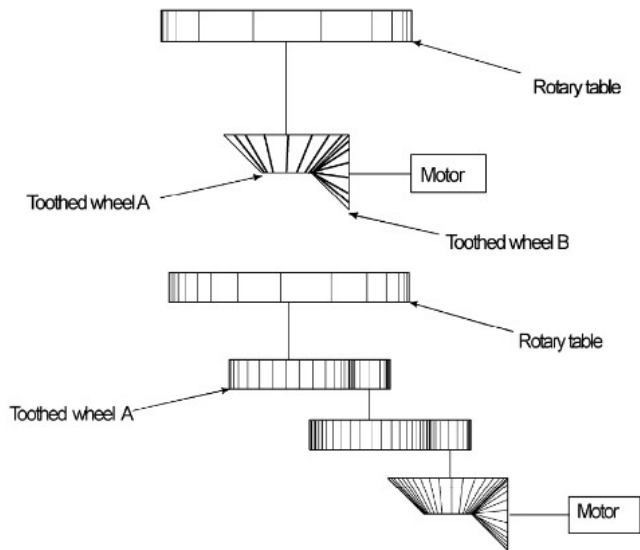

# Periodical Secondary Pitch Error Compensation

## Features

The Periodical Secondary Pitch Error Compensation is used when there is a gear between the motor and shaft of the axis of travel.

To compensate for pitch errors, the compensation for the pitch error due to the rotation of the gear is superimposed on the compensation for the pitch error per rotation of the rotary table. If the gear between the rotary table and the servo motor is of a single stage, as shown below, the stored pitch error compensation is used for the compensation for the pitch error of the toothed wheel A and Periodical Secondary Pitch Error compensation is used for the pitch error of the toothed wheel B.

If there is a multiple-stage gear, as shown below, the stored pitch error compensation is used for toothed wheel A and Periodical Secondary Pitch Error compensation is used for the cyclic pitch error that occurs in each pitch error compensation interval of toothed wheel A.

Although a rotary table is used as an example here, Periodical Secondary Pitch Error compensation can be used in the same way when the machine is moved along a linear axis using a gear. For example, in a configuration such as that shown below, stored pitch error compensation is used for the compensation for the pitch error of the drilling hole and Periodical Secondary Pitch Error compensation is used for the compensation for the pitch error of toothed wheel A.

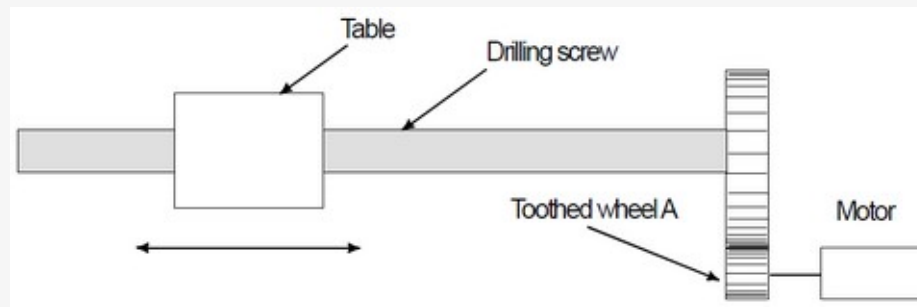

## Benefits

- Increase of the precision in geared systems such as rotation tables
- Improvement of machine precision
- Increase of production quality and overall machine productivity

### Notice

Certain functions may require additional hardware, different CPU type or additional memory capacity or may cause compatibility issue with other functions. In case of doubt, contact your FANUC sales representative for additional information and support.

The information given in the FANUC manuals or original manufacturer documentation shall prevail. Technical data is subject to change without prior notice. No part of this document may be reproduced in any form. All rights reserved. © FANUC 2017



# 408

## Ordering Information

Specification	Description
A02B-0323-S634	30i-B Periodical Secondary Pitch Error Compensation
A02B-0326-S634	31i-B5 Periodical Secondary Pitch Error Compensation
A02B-0327-S634	31i-B Periodical Secondary Pitch Error Compensation
A02B-0328-S634	32i-B Periodical Secondary Pitch Error Compensation

### Notice

Certain functions may require additional hardware, different CPU type or additional memory capacity or may cause compatibility issue with other functions. In case of doubt, contact your FANUC sales representative for additional information and support.

The information given in the FANUC manuals or original manufacturer documentation shall prevail. Technical data is subject to change without prior notice. No part of this document may be reproduced in any form. All rights reserved. © FANUC 2017

# 409

## Accuracy Compensation Functions

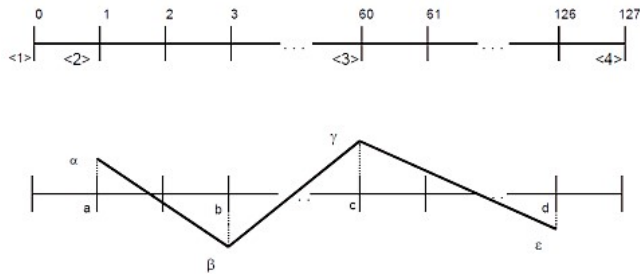

## Inclination Compensation

### Features

The Inclination Compensation function, also called "Gradient Compensation", may be super-imposed on the stored pitch error compensation to reduce the number of points that must be entered for stored pitch error compensation.

Three approximate straight lines are formed with four parameter specified compensation points and compensation amounts related to the respective compensation points.

Inclination compensation is carried out along these approximate straight lines at pitch error compensation intervals. The inclination compensation amount is added to the pitch error compensation amount.

To perform inclination compensation, the Stored Pitch Error Compensation must be set for the axis subject to compensation. Unlike the Stored Pitch Error Compensation function, whose amount is set up for an individual compensation point, an amount of inclination compensation is calculated for individual compensation points by setting up four typical points and compensation amounts for them.

This function can be used to reduce the number of stored pitch error compensation points that must be entered for long ball screws.

### Benefits

- Increase of the precision of systems with long ball screws and large machiens
- Improvement of machine precision
- Increase of production quality and overall machine productivity

### Ordering Information

Specification	Description
A02B-0323-J981	30i-B Inclination Compensation
A02B-0326-J981	31i-B5 Inclination Compensation
A02B-0327-J981	31i-B Inclination Compensation
A02B-0328-J981	32i-B Inclination Compensation
A02B-0333-J981	35i-B Inclination Compensation
A02B-0339-J981	0i-TF Inclination Compensation
A02B-0340-J981	0i-MF Inclination Compensation

#### Notice

Certain functions may require additional hardware, different CPU type or additional memory capacity or may cause compatibility issue with other functions. In case of doubt, contact your FANUC sales representative for additional information and support.

The information given in the FANUC manuals or original manufacturer documentation shall prevail. Technical data is subject to change without prior notice. No part of this document may be reproduced in any form. All rights reserved. © FANUC 2017

# 410

## Accuracy Compensation Functions

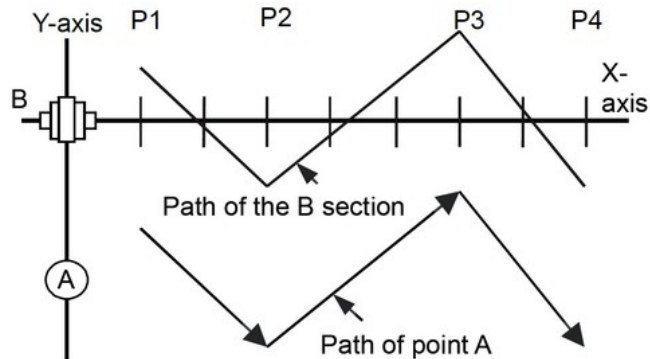

## Straightness Compensation

### Features

The Straightness Compensation function is used to compensate the alignment of two perpendicular axes.

In straightness compensation, similarly to Inclination compensation, four typical pitch error compensation points (a, b, c, and d) are selected from pitch error compensation points and specified as straightness compensation points, and compensation amounts are set up only for these four points.

For pitch error compensation points between straightness compensation points, the CNC calculates and outputs amounts that match straightness compensation. Straightness compensation largely differs from Inclination compensation in that the moving axis is not a compensation axis; Inclination compensation is applied directly to the moving axis.

This relationship is specified by a parameter (for example, to apply compensation to the Y-axis as movement occurs along the X-axis).

### Benefits

- Improvement of the precision for perpendicular axes
- Improvement of machine precision
- Increase of production quality and overall machine productivity

### Ordering Information

Specification	Description
A02B-0323-J747	30i-B Straightness Compensation
A02B-0326-J747	31i-B5 Straightness Compensation
A02B-0327-J747	31i-B Straightness Compensation
A02B-0328-J747	32i-B Straightness Compensation
A02B-0333-J747	35i-B Straightness Compensation
A02B-0339-J747	0i-TF Straightness Compensation
A02B-0339-J799	0i-TF Simple Straightness Compensation
A02B-0340-J747	0i-MF Straightness Compensation
A02B-0340-J799	0i-MF Simple Straightness Compensation

#### Notice

Certain functions may require additional hardware, different CPU type or additional memory capacity or may cause compatibility issue with other functions. In case of doubt, contact your FANUC sales representative for additional information and support.

The information given in the FANUC manuals or original manufacturer documentation shall prevail. Technical data is subject to change without prior notice. No part of this document may be reproduced in any form. All rights reserved. © FANUC 2017

# 411

## Accuracy Compensation Functions

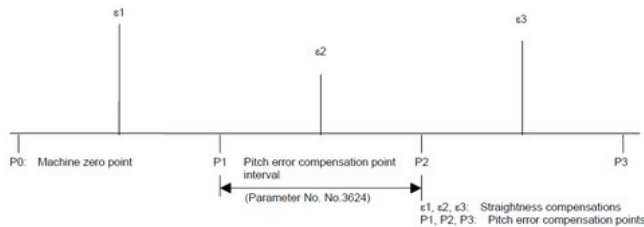

## Interpolation Type Straightness Compensation

### Features

The Interpolation Straightness Compensation function outputs divided compensation pulses between compensation points so that smoother straightness compensation can be realized.

In conventional straightness compensation, for each interval between pitch error compensation points set by parameters, the amount of all straightness compensation at the compensation point is output and compensation is performed. This function equally divides the amount of compensation for each interval between pitch error compensation points for compensation data set using 128 straightness compensation points and outputs it as a compensation pulse.

### Benefits

- Increase of the precision of the compensation for parallel axes
- Improvement of machine precision
- Increase of production quality and overall machine productivity

### Ordering Information

Specification	Description
A02B-0323-S639	30i-B Interpolation Type Straightness Compensation
A02B-0326-S639	31i-B5 Interpolation Type Straightness Compensation
A02B-0327-S639	31i-B Interpolation Type Straightness Compensation
A02B-0328-S639	32i-B Interpolated Type Straightness Compensation
A02B-0339-S639	0i-TF Interpolation Type Straightness Compensation
A02B-0340-S639	0i-MF Interpolation Type Straightness Compensation

#### Notice

Certain functions may require additional hardware, different CPU type or additional memory capacity or may cause compatibility issue with other functions. In case of doubt, contact your FANUC sales representative for additional information and support.

The information given in the FANUC manuals or original manufacturer documentation shall prevail. Technical data is subject to change without prior notice. No part of this document may be reproduced in any form. All rights reserved. © FANUC 2017

# 412

## Accuracy Compensation Functions

# Interpolated Straightness Compensation 3072 Points

---

## Features

The Interpolated Straightness Compensation 3072 Points function increases the number of compensation points to 3072.

The number of points which can be used for one pair of Interpolated straightness compensation is expanded to 1536.

As a result, a more accurate machining can be realized than with the standard compensations performed by the Interpolated Straightness Compensation function.

## Benefits

- Increases significantly the correction accuracy
- Improvement of machine precision
- Increase of production quality and overall machine productivity

## Ordering Information

Specification	Description
A02B-0323-R638	30i-B Interpolation Type Straightness Compensation 3072 Points
A02B-0326-R638	31i-B5 Interpolation Straightness Compensation 3072 Points
A02B-0327-R638	31i-B Interpolation Straightness Compensation 3072 Points
A02B-0339-R638	0i-TF Interpolation Type Straightness Compensation 3072 Points
A02B-0340-R638	0i-MF Interpolation Type Straightness Compensation, 3072 Points

### Notice

Certain functions may require additional hardware, different CPU type or additional memory capacity or may cause compatibility issue with other functions. In case of doubt, contact your FANUC sales representative for additional information and support.

The information given in the FANUC manuals or original manufacturer documentation shall prevail. Technical data is subject to change without prior notice. No part of this document may be reproduced in any form. All rights reserved. © FANUC 2017

# 413

## Accuracy Compensation Functions

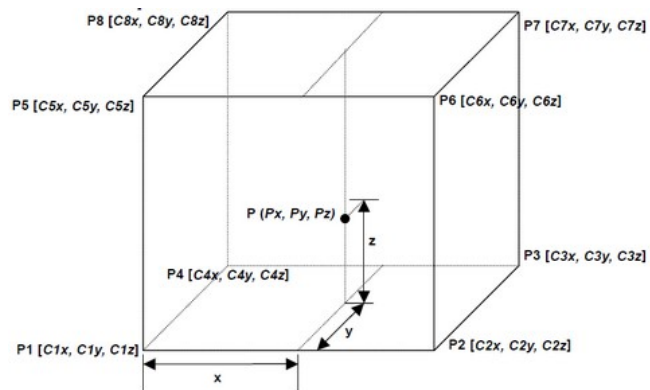

## 3-Dimensional Error Compensation

### Features

In ordinary pitch error compensation, the compensation is applied to a specified compensation axis according to the positional information of that axis. For example, pitch error compensation for the X-axis is performed based on the X-axis positional information.

With the 3-Dimensional Error Compensation function, the compensation is performed for the current position for up to three compensation axes by calculating the compensation data (for three axes) from the compensation amounts at eight periphery compensation points based on the internal ratio in a compensation area (rectangular parallelepiped) including the current position.

### Benefits

- Increase of the correction and compensation efficiency
- Improvement of machine precision
- Increase of production quality and overall machine productivity

### Ordering Information

Specification	Description
A02B-0323-S666	30i-B 3-D Error Compensation
A02B-0326-S666	31i-B5 3-D Error Compensation
A02B-0327-S666	31i-B 3-D Error Compensation

### Notice

Certain functions may require additional hardware, different CPU type or additional memory capacity or may cause compatibility issue with other functions. In case of doubt, contact your FANUC sales representative for additional information and support.

The information given in the FANUC manuals or original manufacturer documentation shall prevail. Technical data is subject to change without prior notice. No part of this document may be reproduced in any form. All rights reserved. © FANUC 2017

# 414

## Accuracy Compensation Functions

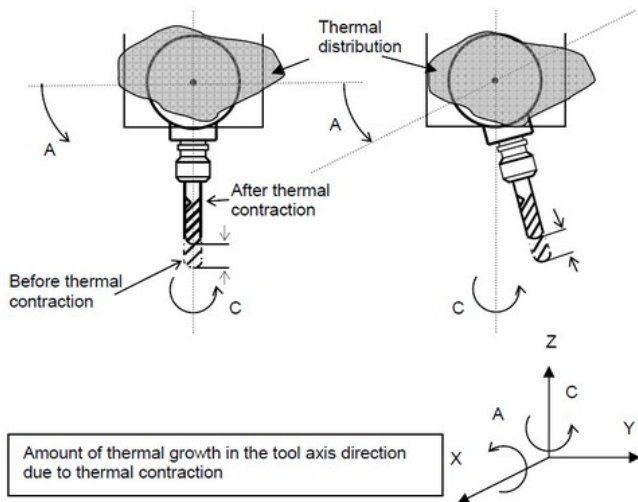

# Thermal Growth Compensation Along Tool Vector

## Features

The Thermal Growth Compensation Along Tool Vector function is used in five-axis machine applications where the tool is controlled by two rotary axes.

The compensation for thermal expansion or shrinkage of the tool can be applied along the tool vector specified with the rotation axes.

This function compensates for the thermal tool displacement set along the tool vector by setting the displacement as the input signal from the PMC or another unit.

## Benefits

- Compensation of thermal effects on 5-axis machines
- Improvement of machine precision
- Increase of production quality and overall machine productivity

## Ordering Information

Specification	Description
A02B-0323-S860	30i-B Thermal Growth Compensation
A02B-0326-S860	31i-B5 Thermal Growth Compensation
A02B-0327-S860	31i-B Thermal Growth Compensation

### Notice

Certain functions may require additional hardware, different CPU type or additional memory capacity or may cause compatibility issue with other functions. In case of doubt, contact your FANUC sales representative for additional information and support.

The information given in the FANUC manuals or original manufacturer documentation shall prevail. Technical data is subject to change without prior notice. No part of this document may be reproduced in any form. All rights reserved. © FANUC 2017

# 415

## Accuracy Compensation Functions

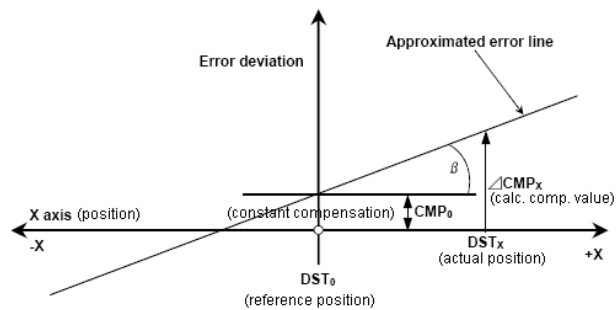

# Linear Inclination Compensation Function

## Features

The Linear Inclination Compensation function compensates the change of state of the machine by the approximated error line by the parameter of straight line slope and slice.

In Inclination Compensation, up to 3 approximated error lines are compensated. This function compensate it by one approximated error line. Moreover, this function can work independently of other compensation functions such as pitch error compensation, etc.

## Benefits

- Improvement of machine precision
- Increase of production quality and overall machine productivity

## Ordering Information

Specification	Description
A02B-0323-R520	30i-B Linear Inclination Compensation Function
A02B-0326-R520	31i-B5 Linear Inclination Compensation Function
A02B-0327-R520	31i-B Linear Inclination Compensation Function
A02B-0328-R520	32i-B Linear Inclination Compensation Function

### Notice

Certain functions may require additional hardware, different CPU type or additional memory capacity or may cause compatibility issue with other functions. In case of doubt, contact your FANUC sales representative for additional information and support.

The information given in the FANUC manuals or original manufacturer documentation shall prevail. Technical data is subject to change without prior notice. No part of this document may be reproduced in any form. All rights reserved. © FANUC 2017



# 416

## Accuracy Compensation Functions

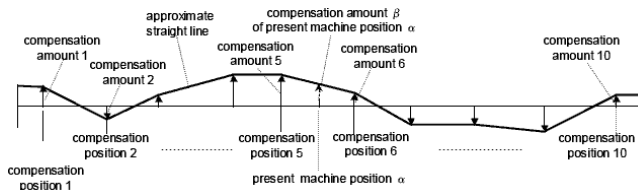

## 3-Dimensional Machine Position Compensation

### Features

The 3-Dimensional Machine Position Compensation function compensates machine position errors that occur during processing along an approximate straight line formed with specified compensation point in a machine coordinate and a compensation amount related to it.

Compensation of this function is carried out along nine approximate straight lines formed with ten compensation points and compensation amounts related to the respective compensation points.

Compensation amounts can be rewritten by the PMC window function or programmable parameter input (G10 L52), in addition, the rewritten value immediately becomes effective. Therefore, this function can be applied to compensation for those machine position errors that occurs during processing.

### Benefits

- Compensation of large machine tools
- Improvement of machine precision
- Increase of production quality and overall machine productivity

### Ordering Information

Specification	Description
A02B-0323-R581	30i-B 3-Dimensional Machine Position Compensation
A02B-0326-R581	31i-B5 3-Dimensional Machine Position Compensation
A02B-0327-R581	31i-B 3-Dimensional Machine Position Compensation
A02B-0328-R581	32i-B 3-Dimensional Machine Position Compensation

### Notice

Certain functions may require additional hardware, different CPU type or additional memory capacity or may cause compatibility issue with other functions. In case of doubt, contact your FANUC sales representative for additional information and support.

The information given in the FANUC manuals or original manufacturer documentation shall prevail. Technical data is subject to change without prior notice. No part of this document may be reproduced in any form. All rights reserved. © FANUC 2017

# 417

## Accuracy Compensation Functions

## 3-Dimensional Rotary Error Compensation

---

### Features

The 3D Rotary Error Compensation improves the correction of geometric machine errors by including not only linear axes but also any rotary axes that are used in the machining envelope.

In contrast to most compensation options, this function is able to process three-dimensional measurement data for the overall machine volume and makes it ideal for five-axis machines.

### Benefits

- Greater Cutting Accuracy and Precision

### Ordering Information

Specification	Description
A02B-0323-R649	30i-B 3-D Rotary Error Compensation
A02B-0326-R649	31i-B5 3-D Rotary Error Compensation
A02B-0327-R649	31i-B 3-D Rotary Error Compensation

#### Notice

Certain functions may require additional hardware, different CPU type or additional memory capacity or may cause compatibility issue with other functions. In case of doubt, contact your FANUC sales representative for additional information and support.

The information given in the FANUC manuals or original manufacturer documentation shall prevail. Technical data is subject to change without prior notice. No part of this document may be reproduced in any form. All rights reserved. © FANUC 2017

# 418

## Functions

## Hobbing / Electronic Gear Box

---

This section of the catalogue contains the functions related to hobbing functions and Electronic Gear Box (EGB) functions for gear cutting and gear grinding machines.

Some of the functions detailed in the catalogue:

- Electronic Gear Box
- Skip function for Electronic Gear Box
- Spindle Electronic Gear Box
- Phase synchronization
- Etc.

### Notice

Certain functions may require additional hardware, different CPU type or additional memory capacity or may cause compatibility issue with other functions. In case of doubt, contact your FANUC sales representative for additional information and support.

The information given in the FANUC manuals or original manufacturer documentation shall prevail. Technical data is subject to change without prior notice. No part of this document may be reproduced in any form. All rights reserved. © FANUC 2017

# 419

## Hobbing / Electronic Gear Box

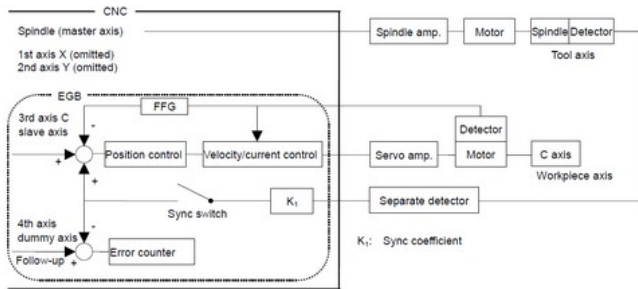

## Electronic Gear Box (EGB)

### Features

This function enables fabrication of high-precision gears, screws, and other components by rotating the workpiece in synchronization with a rotating tool or by moving the tool in synchronization with a rotating workpiece.

The rate of synchronization can be specified with a program. The synchronization of tool and workpiece axes with this function adopts a system in which the synchronization is directly controlled by digital servo, so that the workpiece axis can follow up the speed fluctuations on the tool axis with no error, thereby allowing fabrication of high-precision cogwheels.

### Benefits

- Addition of the Electronic Gear Box (EGB) function to the CNC
- Simplification of the programming
- Improvement of the overall machining productivity

### Ordering Information

Specification	Description
A02B-0323-J779	30i-B Electronic Gear Box
A02B-0326-J779	31i-B5 Electronic Gear Box
A02B-0327-J779	31i-B Electronic Gear Box
A02B-0328-J779	32i-B Electronic Gear Box
A02B-0339-J779	0i-TF Electronic Gear Box (EGB)
A02B-0340-J779	0i-MF Electronic Gear Box (EGB)

### Notice

Certain functions may require additional hardware, different CPU type or additional memory capacity or may cause compatibility issue with other functions. In case of doubt, contact your FANUC sales representative for additional information and support.

The information given in the FANUC manuals or original manufacturer documentation shall prevail. Technical data is subject to change without prior notice. No part of this document may be reproduced in any form. All rights reserved. © FANUC 2017

# 420

## Hobbing / Electronic Gear Box

# Skip Function for Electronic Gear Box (EGB) Axis

## Features

The Skip function for EGB axis enables the skip or high-speed skip signal for the EGB slave axis in synchronization mode with the EGB (electronic gear box).

This function has following features:

1. If a skip signal is input while an EGB axis skip command block is being executed, this block does not terminate until the specified number of skip signals have been input.
2. If a skip signal is input while an EGB axis skip command block is being executed, the tool remains in synchronous mode and moves, not stopping on the EGB slave axis.
3. The machine coordinates assumed when skip signals are input and the number of input skip signals are stored in specified custom macro variables.

## Benefits

- Addition of interaction between external signals and the EGB function
- Simplification of the programming
- Improvement of the overall machining productivity

## Ordering Information

Specification	Description
A02B-0323-J696	30i-B Skip Function for EGB Axis
A02B-0326-J696	31i-B5 Skip Function for EGB Axis
A02B-0327-J696	31i-B Skip Function for EGB Axis
A02B-0328-J696	32i-B Skip Function for EGB Axis
A02B-0339-J696	0i-TF Skip Function for EGB Axis
A02B-0340-J696	0i-MF Skip Function for EGB Axis

### Notice

Certain functions may require additional hardware, different CPU type or additional memory capacity or may cause compatibility issue with other functions. In case of doubt, contact your FANUC sales representative for additional information and support.

The information given in the FANUC manuals or original manufacturer documentation shall prevail. Technical data is subject to change without prior notice. No part of this document may be reproduced in any form. All rights reserved. © FANUC 2017

# 421

## Hobbing / Electronic Gear Box

# Electronic Gear Box (EGB) - 2 pairs

## Features

The Electronic Gear Box (EGB) function is a function for rotating a workpiece in sync with a rotating tool, or to move a tool in sync with a rotating workpiece. With this function, the high-precision machining of gears, threads, and other similar machining processes can be implemented.

A desired synchronization ratio can be programmed. Up to 2 sets of axes can be synchronized. A gear grinding machine can be controlled, for instance, by using one axis for rotating the workpiece in sync with the tool and another axis for performing dressing in sync with the tool.

## Benefits

- Addition of 2 sets of axis in the synchronization
- Simplification of the programming
- Improvement of the overall machining productivity

## Ordering Information

Specification	Description
A02B-0323-S710	30i-B Electronic Gear Box, 2 Pairs
A02B-0326-S710	31i-B5 Electronic Gear Box, 2 Pairs
A02B-0327-S710	31i-B Electronic Gear Box, 2 Pairs
A02B-0328-S710	32i-B Electronic Gear Box, 2 Pairs

### Notice

Certain functions may require additional hardware, different CPU type or additional memory capacity or may cause compatibility issue with other functions. In case of doubt, contact your FANUC sales representative for additional information and support.

The information given in the FANUC manuals or original manufacturer documentation shall prevail. Technical data is subject to change without prior notice. No part of this document may be reproduced in any form. All rights reserved. © FANUC 2017

# 422

## Hobbing / Electronic Gear Box

# Electronic Gear Box (EGB) Automatic Phase Synchronization

## Features

With the Electronic Gear Box (EGB) function active and when synchronization start or cancellation is specified, the synchronization is not started or canceled immediately. Instead, acceleration / deceleration is executed first. In this case, synchronization can be started or canceled while the spindle is rotating; the synchronization ratio can also be changed while the spindle is rotating.

At synchronization start, automatic phase synchronization is performed such that the workpiece axis position matches the position corresponding to the spindle one-rotation signal. With this synchronization, the same operation is performed as synchronization start caused by a one-rotation signal in hobbing synchronization when using the functions of a hobbing machine.

The spindle corresponds to the EGB master axis and the workpiece axis corresponds to an EGB slave axis.

## Benefits

- Addition of automatic synchronization to the EGB function
- Simplification of the programming
- Improvement of the overall machining productivity

## Ordering Information

Specification	Description
A02B-0323-S711	30i-B Electronic Gear Box Automatic Phase Synchronisation
A02B-0326-S711	31i-B5 Electronic Gear Box Automatic Phase Synchronisation
A02B-0327-S711	31i-B Electronic Gear Box Automatic Phase Synchronisation
A02B-0328-S711	32i-B Electronic Gear Box Automatic Phase Synchronisation
A02B-0339-S711	0i-TF Electronic Gear Box Automatic Phase Synchronisation
A02B-0340-S711	0i-MF Electronic Gear Box Automatic Phase Synchronisation

### Notice

Certain functions may require additional hardware, different CPU type or additional memory capacity or may cause compatibility issue with other functions. In case of doubt, contact your FANUC sales representative for additional information and support.

The information given in the FANUC manuals or original manufacturer documentation shall prevail. Technical data is subject to change without prior notice. No part of this document may be reproduced in any form. All rights reserved. © FANUC 2017

# 423

## Hobbing / Electronic Gear Box

# Spindle Electronic Gear Box (EGB)

## Features

A gear can be shaped (grind/cut) by the synchronization of the workpiece axis rotation to the tool axis (grinding axis / hob) rotation using two spindles as a tool axis and a workpiece axis. To synchronize these two axes, the Electronic gear box (EGB) is used.

In the Spindle EGB, the synchronous pulse is produced from the feedback pulse of the position detector attached to the tool axis (master axis) in the motor control, and the workpiece axis (slave axis) rotates with the pulse. Feedback pulse from Master side to Slave side is forwarded by the communication between spindle amplifiers.

The specifications of the Spindle EGB control are as follows:

1. The Spindle EGB synchronization is started by specifying T command (number of teeth) and L command (number of hob threads), which determine the synchronous ratio, in G81 block. The Spindle EGB synchronization is canceled by specifying G80.
2. The synchronous ratio is calculated from T and L command in G81 block and the number of position detector pulses per rotation about the tool and the workpiece axis (parameter setting).
3. This function has the retract function like the hobbing function.
4. The cutting helical gear is performed by specifying Q command (module or diametral pitch) and P command (gear helix angle) in G81 block.
5. The Spindle EGB synchronization is maintained regardless of whether the operation is automatic or manual.

## Benefits

- Addition of the Electronic Gear Box function to Spindle
- Simplification of the programming
- Improvement of the overall machining productivity

## Ordering Information

Specification	Description
A02B-0323-S720	30i-B Spindle Electronic Gear Box
A02B-0326-S720	31i-B5 Spindle Electronic Gear Box
A02B-0327-S720	31i-B Spindle Electronic Gear Box
A02B-0328-S720	32i-B Spindle Electronic Gear Box
A02B-0339-S720	0i-TF Spindle Electronic Gear Box

### Notice

Certain functions may require additional hardware, different CPU type or additional memory capacity or may cause compatibility issue with other functions. In case of doubt, contact your FANUC sales representative for additional information and support.

The information given in the FANUC manuals or original manufacturer documentation shall prevail. Technical data is subject to change without prior notice. No part of this document may be reproduced in any form. All rights reserved. © FANUC 2017



# 424

## Hobbing / Electronic Gear Box

# Flexible Synchronization Control

## Features

The Flexible Synchronization Control function applies to hobbing machines and other machines that require synchronization of multiple sets of axes with various gear ratios.

This function allows up to four individual sets to be synchronized independently. This can implement features specific to the hobbing machine such as synchronization between hobbing axis and a workpiece axis, Z-C synchronization in helical gear cutting, and Y-C synchronization in hobbing axis shift.

The specifications of flexible synchronization control are as follows:

1. The master axis number, slave axis number, and gear ratio are set in parameters.
2. There are four groups of these parameters. Synchronization of four groups can be performed at the same time.
3. For multiple master axes, one slave axis can also be specified.
4. Synchronization is started and canceled by DI signals from the PMC. When DI signal switching is to be made during automatic operation, a parameter-set M code must be used.
5. The two Cs axes can also be used as a master axis and slave axis.
6. The two Cs axes can also be used as a master axis and slave axis.
7. Feedback pulses of the spindle operating as the Cs axis can be used for feed per revolution. The command format is G95P<sub>;</sub>, where P<sub>;</sub> is the axis number of Cs axis.

## Benefits

- Addition of automatic synchronization to the Electronic Gear Box function
- Simplification of the programming
- Improvement of the overall machining productivity

## Ordering Information

Specification	Description
A02B-0323-S709	30i-B Flexible Synchronous Control
A02B-0326-S709	31i-B5 Flexible Synchronous Control
A02B-0327-S709	31i-B Flexible Synchronous Control
A02B-0328-S709	32i-B Flexible Synchronous Control
A02B-0339-S709	0i-TF Flexible Synchronous Control
A02B-0340-S709	0i-MF Flexible Synchronous Control

### Notice

Certain functions may require additional hardware, different CPU type or additional memory capacity or may cause compatibility issue with other functions. In case of doubt, contact your FANUC sales representative for additional information and support.

The information given in the FANUC manuals or original manufacturer documentation shall prevail. Technical data is subject to change without prior notice. No part of this document may be reproduced in any form. All rights reserved. © FANUC 2017

# 425

## Hobbing / Electronic Gear Box

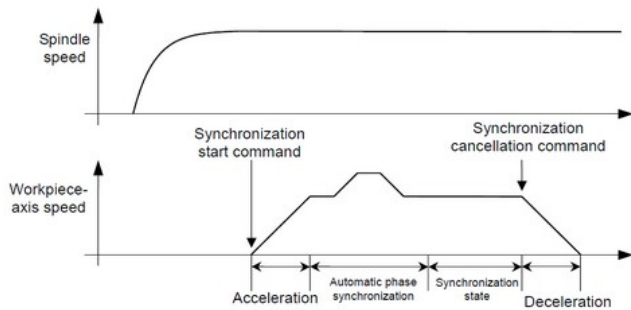

# Automatic Phase Synchronization for Flexible Synchronization Control

## Features

In the flexible synchronous control, when synchronization start or cancellation is specified, acceleration/deceleration is executed.

By this acceleration/deceleration, synchronization can be started or canceled while the master axis is moving.

Also, automatic phase synchronization can be performed such that the machine coordinate zero position of the master axis matches the slave axis machine coordinate position at the synchronization start.

## Benefits

- Addition of automatic synchronization to the Electronic Gear Box function
- Simplification of the programming
- Improvement of the overall machining productivity

## Ordering Information

Specification	Description
A02B-0323-S611	30i-B Automatic Phase Synchronization for Flexible Synchronous Control
A02B-0326-S611	31i-B5 Automatic Phase Synchronization for Flexible Synchronous Control
A02B-0327-S611	31i-B Automatic Phase Synchronization for Flexible Synchronous Control
A02B-0328-S611	32i-B Automatic Phase Synchronization for Flexible Synchronous Control
A02B-0339-S611	0i-TF Automatic Phase Synchronisation for Flexible Synchronous Control
A02B-0340-S611	0i-MF Automatic Phase Synchronisation for Flexibale Synchronous Control

### Notice

Certain functions may require additional hardware, different CPU type or additional memory capacity or may cause compatibility issue with other functions. In case of doubt, contact your FANUC sales representative for additional information and support.

The information given in the FANUC manuals or original manufacturer documentation shall prevail. Technical data is subject to change without prior notice. No part of this document may be reproduced in any form. All rights reserved. © FANUC 2017

# 426

## Hobbing / Electronic Gear Box

# Inter-Path Flexible Synchronization Control

## Features

The Inter-Path Flexible Synchronous Control function enables flexible synchronous control between axes in different paths in multi paths system.

Up to 4 slave axes can be specified in one path. An axis in other path can be specified as master axis of each slave axes. All synchronization pairs in all paths can be performed simultaneously.

## Benefits

- Increase of machine design flexibility
- Simplification of the programming
- Improvement of the overall machining productivity

## Ordering Information

Specification	Description
A02B-0323-S610	30i-B Inter-Path Flexible Synchronous Control
A02B-0326-S610	31i-B5 Inter-Path Flexible Synchronous Control
A02B-0327-S610	31i-B Inter-Path Flexible Synchronous Control
A02B-0328-S610	32i-B Inter-Path Flexible Synchronous Control
A02B-0339-S610	0i-TF Inter-Path Flexible Synchronous Control
A02B-0340-S610	0i-MF Inter-Path Flexible Synchronous Control

### Notice

Certain functions may require additional hardware, different CPU type or additional memory capacity or may cause compatibility issue with other functions. In case of doubt, contact your FANUC sales representative for additional information and support.

The information given in the FANUC manuals or original manufacturer documentation shall prevail. Technical data is subject to change without prior notice. No part of this document may be reproduced in any form. All rights reserved. © FANUC 2017

# 427

## Hobbing / Electronic Gear Box

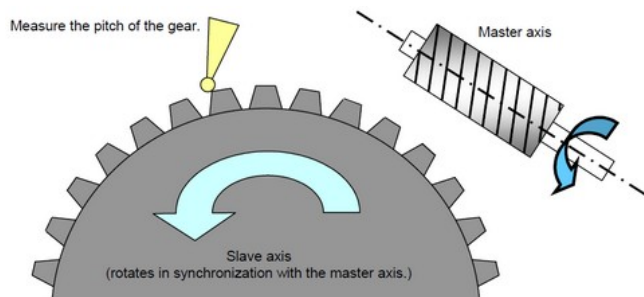

# Skip Function for Flexible Synchronization Control

## Features

This function provides the capability that skip function or high speed skip function can be commanded for the slave axis in the flexible synchronous control mode.

Features:

- The program block to enable the function is not interrupted until the total number of skip signal inputs reaches a value specified in the same block
- The machine coordinate position of the slave axis at each time of the signal inputs is stored in one of consecutive custom macro variables. The top number of the variables is specified in the block.
- The total number of the inputs is stored in another specified variable.

## Benefits

- Addition of event driven control capabilities to the flexible synchronous control mode
- Simplification of the programming
- Improvement of the overall machining productivity

## Ordering Information

Specification	Description
A02B-0323-S612	30i-B Skip Function for Flexible Synchronous Control
A02B-0326-S612	31i-B5 Skip Function for Flexible Synchronous Control
A02B-0327-S612	31i-B Skip Function for Flexible Synchronous Control
A02B-0328-S612	32i-B Skip Function for Flexible Synchronous Control
A02B-0339-S612	0i-TF Skip Function for Flexible Synchronous Control
A02B-0340-S612	0i-MF Skip Function for Flexible Synchronous Control

### Notice

Certain functions may require additional hardware, different CPU type or additional memory capacity or may cause compatibility issue with other functions. In case of doubt, contact your FANUC sales representative for additional information and support.

The information given in the FANUC manuals or original manufacturer documentation shall prevail. Technical data is subject to change without prior notice. No part of this document may be reproduced in any form. All rights reserved. © FANUC 2017

# 428

## Hobbing / Electronic Gear Box

# Hob Command by Flexible Synchronization Control

## Features

Allows the use of the hob command (G81/G81.4) prepared in the Electronic Gear Box function as a synchronization command for the Flexible synchronization control.

## Benefits

- Easy gear processing by flexible synchronization control

Flexible synchronization control option is required

## Ordering Information

Specification	Description
A02B-0323-R847	30i-B Hob Command by Flexible Synchronisation Control
A02B-0326-R847	31i-B5 Hob Command by Flexible Synchronisation Control
A02B-0327-R847	31i-B Hob Command by Flexible Synchronisation Control
A02B-0328-R847	32i-B Hob Command by Flexible Synchronisation Control
A02B-0339-R847	0i-TF Hob Command by Flexible Synchronous Control
A02B-0340-R847	0i-MF Hob Command by Flexible Synchronous Control

### Notice

Certain functions may require additional hardware, different CPU type or additional memory capacity or may cause compatibility issue with other functions. In case of doubt, contact your FANUC sales representative for additional information and support.

The information given in the FANUC manuals or original manufacturer documentation shall prevail. Technical data is subject to change without prior notice. No part of this document may be reproduced in any form. All rights reserved. © FANUC 2017

# 429

## Hobbing / Electronic Gear Box

## U-Axis Control 2 pairs

### Features

The U-axis control function enables two synchronous U-axis pairs to remain in a fixed position or to move at a programmed speed without using a mechanism such as a planetary gear box.

### Benefits

- Change of diameter being machined during multitasking machining operations

### Ordering Information

Specification	Description
A02B-0323-R659	30i-B U-Axis Control 2 Pairs
A02B-0326-R659	31i-B5 U-Axis Control 2 Pairs
A02B-0327-R659	31i-B U-Axis Control 2 Pairs

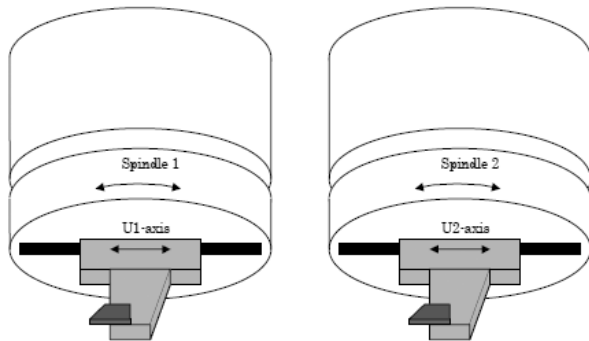

#### Notice

Certain functions may require additional hardware, different CPU type or additional memory capacity or may cause compatibility issue with other functions. In case of doubt, contact your FANUC sales representative for additional information and support.

The information given in the FANUC manuals or original manufacturer documentation shall prevail. Technical data is subject to change without prior notice. No part of this document may be reproduced in any form. All rights reserved. © FANUC 2017

# 430

## Functions

# Grinding Functions

## Features

The "Grinding Function A" package contains the following items:

- Multi-step skip
- Canned cycles for grinding
- Continuous dressing (0i-MF only)
- Infeed control (0i-MF only)

The "Grinding Function B" package contains the same functions as "Grinding Function A" and also the Angular Axis Control function.

Note: for more information about the functions included in the packages, refer to their respective descriptions in this catalogue.

## Benefits

- Simplification of the selection of the control functions required for popular grinding machine

## Ordering Information

Specification	Description
A02B-0339-S682	0i-TF Grinding Function A
A02B-0339-S683	0i-TF Grinding Function B
A02B-0340-S682	0i-MF Grinding Function A
A02B-0340-S683	0i-MF Grinding Function B

### Notice

Certain functions may require additional hardware, different CPU type or additional memory capacity or may cause compatibility issue with other functions. In case of doubt, contact your FANUC sales representative for additional information and support.

The information given in the FANUC manuals or original manufacturer documentation shall prevail. Technical data is subject to change without prior notice. No part of this document may be reproduced in any form. All rights reserved. © FANUC 2017

# 431

## Functions

# Punch Press Functions

---

This section of the catalogue contains the functions related to Punch Press machines.

### Notice

Certain functions may require additional hardware, different CPU type or additional memory capacity or may cause compatibility issue with other functions. In case of doubt, contact your FANUC sales representative for additional information and support.

The information given in the FANUC manuals or original manufacturer documentation shall prevail. Technical data is subject to change without prior notice. No part of this document may be reproduced in any form. All rights reserved. © FANUC 2017



# 432

## Punch Press Functions

```
N3221 G90 G00 X110. Y160. C0.  
N3222 G72 X50. Y100.  
N3223 G26 I60. J90. K4 C45.
```

#1 to #4 : Order of punch motion in N3223  
→ : Path of tool

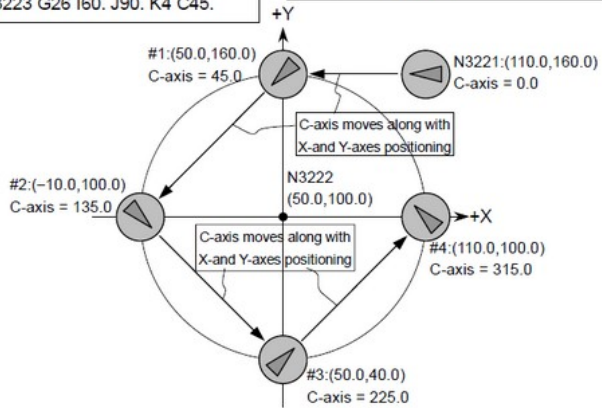

## C-Axis Control

### Features

The C-Axis Control function consist of the following functions:

- C-axis control (die angle indexing)
- C-axis synchronization control
- C-axis offset function

This function is a basic function in FANUC Series 0i-PF.

### C-axis control (die-angle indexing)

For predetermined dies (tools) on a turret, the angular position of the die can be changed with a command from a tape, a memory or MDI.

In the past, it was necessary to use many dies when the die shape is the same but the die arrangement is different. Even in such a case, this new function makes it possible to conduct the operations only with one die since the function can freely change the angular position of the die. Further, since chamfering of four corners of a workpiece can be performed only with one die, the time required for die change is reduced, resulting in shorter machining time.

Further, in pattern function for a circular geometry bolt hole circle, arc pattern, and arc nibbling function, the C axis is automatically controlled so that one side of the die always faces the center of arc at each punching position.

### C-axis synchronization control

The C-axis synchronization control function enables operation of the punch section of the die in sync with the die section of the die by using a separate servo motor for each section.

C-axis synchronization control simultaneously issues the same command to both servo motors. So, synchronization error correction, normally required to detect and reduce deviation between the two servo motors during synchronous operation, is not applied. In C-axis synchronization control, the master axis is referred to as the C1-axis, and the slave axis as the C2-axis.

### C-axis offset function

For the punch press, a tool is used which allows the angle to be changed according to the machine. This type of rotary tool is subject to CNC C-axis control. A C command is used to change the angular position of a tool. When a machine controlling multiple tools of this type is used, mechanical adjustment of each tool is necessary to ensure correct punching.

#### Notice

Certain functions may require additional hardware, different CPU type or additional memory capacity or may cause compatibility issue with other functions. In case of doubt, contact your FANUC sales representative for additional information and support.

The information given in the FANUC manuals or original manufacturer documentation shall prevail. Technical data is subject to change without prior notice. No part of this document may be reproduced in any form. All rights reserved. © FANUC 2017

# 433

This function simplifies mechanical adjustment by performing automatic C-axis offset when indexing up to 20 tools that allow angle changes. A machine that uses C-axis synchronization control enables offset to be performed separately for each of the C1-axis and C2-axis.

## Benefits

- Reduction of the number of dies
- Simplification of the mechanical adjustments
- Increase of the productivity of the punch press

## Ordering Information

Specification	Description
A02B-0331-J601	30i-PB C-Axis Control
A02B-0332-J601	31i-PB C-Axis Control

### Notice

Certain functions may require additional hardware, different CPU type or additional memory capacity or may cause compatibility issue with other functions. In case of doubt, contact your FANUC sales representative for additional information and support.

The information given in the FANUC manuals or original manufacturer documentation shall prevail. Technical data is subject to change without prior notice. No part of this document may be reproduced in any form. All rights reserved. © FANUC 2017

# 434

## Punch Press Functions

# T- and C-Axes Simultaneous Control

## Features

The conventional turret punch press cannot make a T-axis movement and C-axis movement simultaneously because of mechanical constraints. If the T and C commands are simultaneously specified, the CNC executes the commands successively.

Recently, machines without these mechanical constraints have been developed. The T-axis / C-axis simultaneous control function enables simultaneous control of the T-axis and C-axis on those new machines, consequently reducing the cycle time.

## Benefits

- Reduction of the cycle time of the punch press
- Increase of the machine productivity

## Ordering Information

Specification	Description
A02B-0331-S907	30i-PB T- and C-Axes Simultaneous Control
A02B-0332-S907	31i-PB T- and C-Axes Simultaneous Control
A02B-0338-S907	0i-PF T- and C-Axes Simultaneous Control

### Notice

Certain functions may require additional hardware, different CPU type or additional memory capacity or may cause compatibility issue with other functions. In case of doubt, contact your FANUC sales representative for additional information and support.

The information given in the FANUC manuals or original manufacturer documentation shall prevail. Technical data is subject to change without prior notice. No part of this document may be reproduced in any form. All rights reserved. © FANUC 2017

# 435

## Punch Press Functions

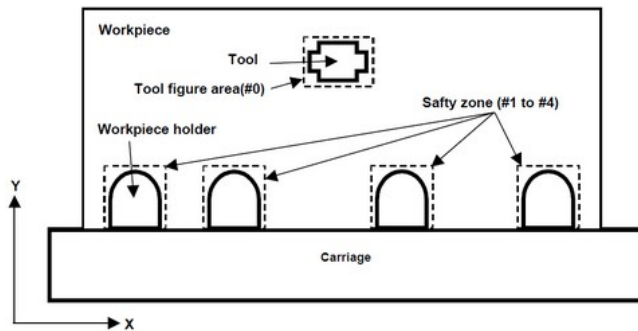

## Safety Zone Check

### Features

This is the safety function to set the safety zone for protecting the workpiece holder that holds the workpiece set on the carriage, and disable punching in that area or forbid the tool to approach thereinto.

This function permits to set tool figure area (#0) and up to four safety zones (#1 - #4), as shown above. Two types of safety zone check methods are available.

This function is a basic function in FANUC Series 0i-PF.

### Benefits

- Reduce risks on the machine and breakdowns
- Increase the overall machine productivity

### Ordering Information

Specification	Description
A02B-0331-J605	30i-PB Safety Zone Check
A02B-0332-J605	31i-PB Safety Zone Check

### Notice

Certain functions may require additional hardware, different CPU type or additional memory capacity or may cause compatibility issue with other functions. In case of doubt, contact your FANUC sales representative for additional information and support.

The information given in the FANUC manuals or original manufacturer documentation shall prevail. Technical data is subject to change without prior notice. No part of this document may be reproduced in any form. All rights reserved. © FANUC 2017

# 436

## Punch Press Functions

# Safety Zone Area Expansion

---

## Features

This function extends the safety zone check function as follows:

- Extends the safety zone check areas: Up to 8
- Extends the safety zone tool areas: Up to 16
- Adds interference safety zone area signals (DO signals): Fn228, Fn238
- Improves the automatic safety-zone setting

## Benefits

- Support of large punch press machines with multiple settings
- Reduce risks on the machine and breakdowns
- Increase the overall machine productivity

## Ordering Information

Specification	Description
A02B-0331-S908	30i-PB Safety Zone Area Expansion
A02B-0332-S908	31i-PB Safety Zone Area Expansion
A02B-0338-S908	0i-PF Safety Zone Area Expansion

### Notice

Certain functions may require additional hardware, different CPU type or additional memory capacity or may cause compatibility issue with other functions. In case of doubt, contact your FANUC sales representative for additional information and support.

The information given in the FANUC manuals or original manufacturer documentation shall prevail. Technical data is subject to change without prior notice. No part of this document may be reproduced in any form. All rights reserved. © FANUC 2017

# 437

## Punch Press Functions

# Clamp Zone Avoidance Function

---

## Features

By means of this function, the CNC monitors the positions of the tool and workpiece holder to avoid interference between the workpiece holder and tool.

Interference can be avoided automatically by the CNC or by the PMC, by using the DI/DO signals.

## Ordering Information

Specification	Description
A02B-0331-J622	30i-PB Clamp Zone Avoidance Function
A02B-0332-J622	31i-PB Clamp Zone Avoidance Function
A02B-0338-J622	0i-PF Clamp Zone Avoidance Function

### Notice

Certain functions may require additional hardware, different CPU type or additional memory capacity or may cause compatibility issue with other functions. In case of doubt, contact your FANUC sales representative for additional information and support.

The information given in the FANUC manuals or original manufacturer documentation shall prevail. Technical data is subject to change without prior notice. No part of this document may be reproduced in any form. All rights reserved. © FANUC 2017

# 438

## Punch Press Functions

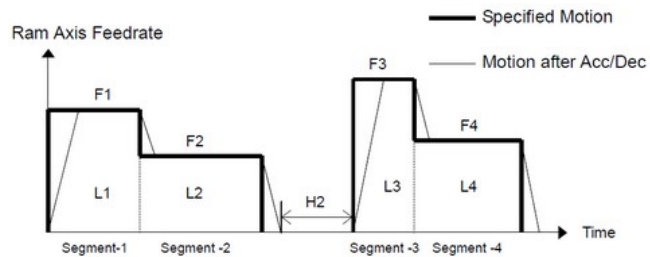

## RAM-Axis Control

### Features

The CNC cannot move RAM-axis by program command.

With this function, the RAM-axis moves automatically at the end of the block executing 1-cycle press by setting RAM-axis and the RAM-axis motion patterns.

### Benefits

- Simplification of the RAM axis command
- Increase of the punching quality

### Ordering Information

Specification	Description
A02B-0331-S919	30i-PB RAM Axis Control
A02B-0332-S919	31i-PB RAM Axis Control
A02B-0338-S919	0i-PF RAM Axis Control

### Notice

Certain functions may require additional hardware, different CPU type or additional memory capacity or may cause compatibility issue with other functions. In case of doubt, contact your FANUC sales representative for additional information and support.

The information given in the FANUC manuals or original manufacturer documentation shall prevail. Technical data is subject to change without prior notice. No part of this document may be reproduced in any form. All rights reserved. © FANUC 2017

# 439

## Punch Press Functions

# Program Auto Restart

---

## Features

When a laser cutting process is interrupted (by a reset operation or a power failure) the Program Auto Restart function provides the possibility to restart the cutting from the interruption point.

## Benefits

- Fast restart of the production after an interruption
- Simplification of the programming of the restart process
- Overall increase of the machine productivity

## Ordering Information

Specification	Description
A02B-0331-S904	30i-PB Automatic Program Restart
A02B-0332-S904	31i-PB Automatic Program Restart
A02B-0338-S904	0i-PF Program Automatic Restart

### Notice

Certain functions may require additional hardware, different CPU type or additional memory capacity or may cause compatibility issue with other functions. In case of doubt, contact your FANUC sales representative for additional information and support.

The information given in the FANUC manuals or original manufacturer documentation shall prevail. Technical data is subject to change without prior notice. No part of this document may be reproduced in any form. All rights reserved. © FANUC 2017



# 440

## Punch Press Functions

# Linear/Circular Punch Command

---

## Features

These commands specify the punch operation from start to end point taking tool diameter and punch interval into account.

## Ordering Information

Specification	Description
A02B-0331-J602	30i-PB Linear / Circular Punch Command
A02B-0332-J602	31i-PB Linear / Circular Punch Command
A02B-0338-J602	0i-PF Linear / Circular Punch Command

### Notice

Certain functions may require additional hardware, different CPU type or additional memory capacity or may cause compatibility issue with other functions. In case of doubt, contact your FANUC sales representative for additional information and support.

The information given in the FANUC manuals or original manufacturer documentation shall prevail. Technical data is subject to change without prior notice. No part of this document may be reproduced in any form. All rights reserved. © FANUC 2017

# 441

## Punch Press Functions

# Y-Axis Crack Cancel

---

## Features

With this function, when the M-codes which are set by parameters are commanded, the crack between work coordinate system and machine coordinate system of Y-axis repositioning motion is canceled.

## Example 1

Y1525M30

Y-axis moves including the crack of repositioning.

## Example 2

Y1525 ;

M30 ;

The work coordinate system is preset to the machine coordinate system to cancel the crack of repositioning by M30. (Y-axis does not move.)

## Benefits

- Simplification of the programming

## Ordering Information

Specification	Description
A02B-0331-J616	30i-PB Y-Axis Crack Cancel
A02B-0332-J616	31i-PB Y-Axis Crack Cancel
A02B-0338-J616	0i-PF Y-Axis Crack Cancel

### Notice

Certain functions may require additional hardware, different CPU type or additional memory capacity or may cause compatibility issue with other functions. In case of doubt, contact your FANUC sales representative for additional information and support.

The information given in the FANUC manuals or original manufacturer documentation shall prevail. Technical data is subject to change without prior notice. No part of this document may be reproduced in any form. All rights reserved. © FANUC 2017

# 442

## Punch Press Functions

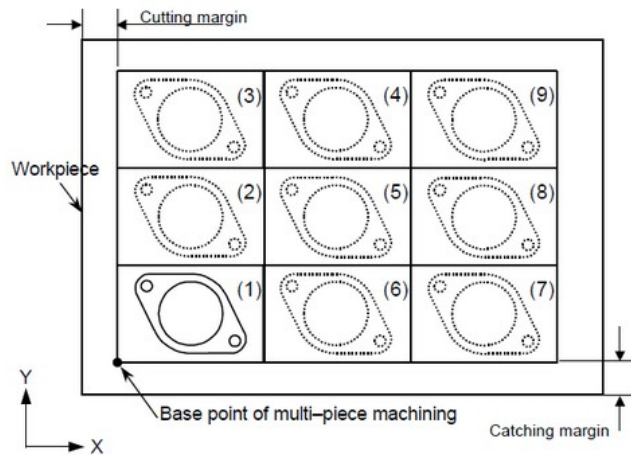

### Notice

Certain functions may require additional hardware, different CPU type or additional memory capacity or may cause compatibility issue with other functions. In case of doubt, contact your FANUC sales representative for additional information and support.

The information given in the FANUC manuals or original manufacturer documentation shall prevail. Technical data is subject to change without prior notice. No part of this document may be reproduced in any form. All rights reserved. © FANUC 2017

## Multi-Piece Machining

### Features

The multi-piece machining function enables several sheets of product with the same punching shape to be produced from a single sheet of material at a time by simple commands.

This function allows so called "trial machining" that performs punching only on a sheet of product from the machining program for "multi-piece machining" by a simple setup method, therefore the machining program can be easily checked before full machining.

This function is a basic function in FANUC Series 0i-PF.

### Benefits

- Simplification of the programming
- Overall increase of the machine efficiency and productivity

### Ordering Information

Specification	Description
A02B-0331-J603	30i-PB Multi-Piece Machining
A02B-0332-J603	31i-PB Multi-Piece Machining

# 443

## Punch Press Functions

# Multi-Piece Machining End Area Command

---

## Features

End area can be specified in Multi-piece machining commands blocks.

## Benefits

- Efficiency improvement of Multi-piece machining

## Ordering Information

Specification	Description
A02B-0331-S927	30i-PB Multi-Piece Machining End Area Command
A02B-0332-S927	31i-PB Multi-Piece Machining End Area Command
A02B-0338-S927	0i-PF Multi-Piece Machining End Area Command

### Notice

Certain functions may require additional hardware, different CPU type or additional memory capacity or may cause compatibility issue with other functions. In case of doubt, contact your FANUC sales representative for additional information and support.

The information given in the FANUC manuals or original manufacturer documentation shall prevail. Technical data is subject to change without prior notice. No part of this document may be reproduced in any form. All rights reserved. © FANUC 2017

# 444

## Punch Press Functions

# Tool Data Setting Function

---

## Features

This function makes the area used for registering tool numbers, tool position compensation, punch count and other tool data available to the user.

This enables the user to customize the registered tool data. This allows the conventional tool data setting method to be changed and the number of tools that can be registered to be increased considerably.

## Benefits

- Increase of the flexibility of the machine

## Ordering Information

Specification	Description
A02B-0331-J621	30i-PB Tool Data Setting Function
A02B-0332-J621	31i-PB Tool data Setting Function
A02B-0338-J621	0i-PF Tool Data Setting Function

### Notice

Certain functions may require additional hardware, different CPU type or additional memory capacity or may cause compatibility issue with other functions. In case of doubt, contact your FANUC sales representative for additional information and support.

The information given in the FANUC manuals or original manufacturer documentation shall prevail. Technical data is subject to change without prior notice. No part of this document may be reproduced in any form. All rights reserved. © FANUC 2017

# 445

## Punch Press Functions

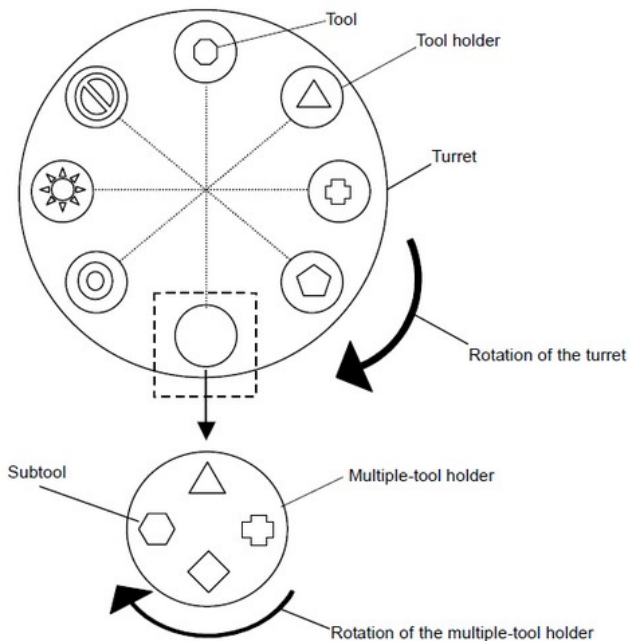

## Multiple Tool Control

### Features

A common way of handling the tools, i.e., the metal dies, for punch presses is to store each die in the tool holder. To select a tool, it is necessary to index the magazine containing the required tool holder to the position at which the tool is changed with a T command and to set the tool holder on the punch holder at that position.

In the multiple-tool system, however, one tool holder contains different types of metal dies. This makes it possible to change tools by simply moving the relevant tool holder. The multiple-tool system, therefore, reduces the time taken to change tools and enables a larger variety of tools to be used, enhancing the range of machining that can be performed.

This function is a basic function in FANUC Series 0i-PF.

### Benefits

- Increase of the flexibility and efficiency of the machine

### Ordering Information

Specification	Description
A02B-0331-J604	30i-PB Multiple Tool Control
A02B-0332-J604	31i-PB Multiple Tool Control

### Notice

Certain functions may require additional hardware, different CPU type or additional memory capacity or may cause compatibility issue with other functions. In case of doubt, contact your FANUC sales representative for additional information and support.

The information given in the FANUC manuals or original manufacturer documentation shall prevail. Technical data is subject to change without prior notice. No part of this document may be reproduced in any form. All rights reserved. © FANUC 2017

# 446

## Punch Press Functions

# Tool Life Management

---

## Features

The function sets the maximum punch count for each tool on the screen. If the actual punch count for a selected tool exceeds the predetermined maximum punch count, tool expired signal PTLCH is output.

Upon detecting this signal, the PMC outputs an alarm or instructs the operator to change the tool.

This function is a basic function in FANUC Series 0i-PF.

## Benefits

- Increase of the quality of the machining

## Ordering Information

Specification	Description
A02B-0331-J614	30i-PB Tool Life Management
A02B-0332-J614	31i-PB Tool Life Management

### Notice

Certain functions may require additional hardware, different CPU type or additional memory capacity or may cause compatibility issue with other functions. In case of doubt, contact your FANUC sales representative for additional information and support.

The information given in the FANUC manuals or original manufacturer documentation shall prevail. Technical data is subject to change without prior notice. No part of this document may be reproduced in any form. All rights reserved. © FANUC 2017

# 447

## Punch Press Functions

# High Speed Press Function

## Features

This function speeds up the execution of the following functions:

- 1-Cycle Press
- Nibbling function, Nibbling by M function
- High-Speed Press Control
- External Operation function
- RAM-Axis Control

The processing time of the punch finish signal \*PFIN / nibble finish signal \*NFIN is decreased, reducing the time between consecutive positioning blocks.

## Benefits

- Improve the machine hit rate by about 5 to 15%
- Reduce the cycle time of punch presses and increase productivity

## Ordering Information

Specification	Description
A02B-0338-S929	0i-PF High Speed Press Function

### Notice

Certain functions may require additional hardware, different CPU type or additional memory capacity or may cause compatibility issue with other functions. In case of doubt, contact your FANUC sales representative for additional information and support.

The information given in the FANUC manuals or original manufacturer documentation shall prevail. Technical data is subject to change without prior notice. No part of this document may be reproduced in any form. All rights reserved. © FANUC 2017



# 448

## Functions

# Laser Functions

---

This section of the catalogue contains the functions related to the CO2 Laser systems of FANUC.

Some of the functions detailed in the catalogue:

- Standard functions
- Gap control
- Cutting settings
- Laser high-speed control
- Etc.

### Notice

Certain functions may require additional hardware, different CPU type or additional memory capacity or may cause compatibility issue with other functions. In case of doubt, contact your FANUC sales representative for additional information and support.

The information given in the FANUC manuals or original manufacturer documentation shall prevail. Technical data is subject to change without prior notice. No part of this document may be reproduced in any form. All rights reserved. © FANUC 2017

# 449

## Laser Functions



## Standard Laser Functions

### Features

The Series 30i-LB or Series 31i-LB CNC are specialized CNC that can be connected to a FANUC CO2 laser oscillator via a dedicated interface and can be used to control a high-performance laser machine easily.

Beside the standard CNC function set, the Series 30i-LB or Series 31i-LB CNC feature a rich set of specialized functions for laser control and laser machine control.

### Key functions:

- Connection via a serial interface: the FANUC I/O LINK interface is used to connect the Series 30i-LB and Series 31i-LB CNC to a FANUC laser oscillator
- Laser Oscillator control: the following functions are provided in the LB CNC:
  - Oscillator start/stop sequence control
  - Automatic laser output compensation
  - Laser output feedback
  - Laser gas pressure control
  - Leakage check
  - Electric shutter control
  - Return light detection
  - Parameter management for uniform oscillator output
- Output control in synchronization with interpolation calculation:
  - Change an output command in each block separately
  - Control the output quickly without wasting time
  - Change the output without causing discontinuance between move commands
  - Control the output control according to the command type
- Automation of functions such as:
  - Assist gas control
  - Saving and restoring machining condition data
  - High-speed piercing control
  - Cutting restart function based on the retrace function

### Benefits

- Fast and performant integration of a laser machine

#### Notice

Certain functions may require additional hardware, different CPU type or additional memory capacity or may cause compatibility issue with other functions. In case of doubt, contact your FANUC sales representative for additional information and support.

The information given in the FANUC manuals or original manufacturer documentation shall prevail. Technical data is subject to change without prior notice. No part of this document may be reproduced in any form. All rights reserved. © FANUC 2017



# 451

## Laser Functions

# Addition of Cutting Condition Data

---

## Features

By specifying the addition of cutting condition data option, the specifications of the conventional cuttingcondition setting function are expanded.

## Ordering Information

Specification	Description
A02B-0329-S912	30i-LB Addition of Cutting Condition Data
A02B-0330-S912	31i-LB Addition of Cutting Condition Data

### Notice

Certain functions may require additional hardware, different CPU type or additional memory capacity or may cause compatibility issue with other functions. In case of doubt, contact your FANUC sales representative for additional information and support.

The information given in the FANUC manuals or original manufacturer documentation shall prevail. Technical data is subject to change without prior notice. No part of this document may be reproduced in any form. All rights reserved. © FANUC 2017

# 452

## Laser Functions

### Edge Machine Function

---

#### Features

The edge cutting function detects edges, controls deceleration-to-stop, performs piercing, and controls the feed rate and power during a shift from piercing to cutting.

It is capable of producing sharper edges. Using this function requires the cutting condition setting function.

#### Benefits

- Improvement of the cutting quality in edges
- Increase the quality of the cut and the performance of the machine
- Overall increase of the machine productivity

#### Ordering Information

Specification	Description
A02B-0329-J833	30i-LB Edge Cutting Function
A02B-0330-J833	31i-LB Edge Cutting Function

#### Notice

Certain functions may require additional hardware, different CPU type or additional memory capacity or may cause compatibility issue with other functions. In case of doubt, contact your FANUC sales representative for additional information and support.

The information given in the FANUC manuals or original manufacturer documentation shall prevail. Technical data is subject to change without prior notice. No part of this document may be reproduced in any form. All rights reserved. © FANUC 2017

# 453

## Laser Functions

# Minimum Unit 1% Duty Override

---

## Features

This function allows to override the current laser pulse duty with an resolution of 1% compared to the standard resolution of 10%. The override value can be specified within a range of 0 to 200%. With this function, it is possible to adjust the laser pulse duty during cutting with a finer graduation.

## Benefits

- Improves the quality of the cutting surface

## Ordering Information

Specification	Description
A02B-0329-S925	30i-LB Minimum Command 1 % Duty Override
A02B-0330-S925	31i-LB Minimum Command 1 % Duty Override

### Notice

Certain functions may require additional hardware, different CPU type or additional memory capacity or may cause compatibility issue with other functions. In case of doubt, contact your FANUC sales representative for additional information and support.

The information given in the FANUC manuals or original manufacturer documentation shall prevail. Technical data is subject to change without prior notice. No part of this document may be reproduced in any form. All rights reserved. © FANUC 2017

# 454

## Laser Functions

# Laser High-Speed Control Function 2

## Features

This function allows to transfer 4 sets of laser output conditions every 8msec in AI-NANO contour control mode to the laser oscillator via FSSB I/O. The Laser output can be controlled every 125msec by commanding the laser output conditions to the laser oscillator via FSSB I/O.

4 sets of laser output conditions such as laser power or block overlap position are transferred to DSP software for laser control in AI-NANO contour control mode. The DSP software controls 1 laser output conditions every 125 u sec and commands to laser oscillator via FSSB I/O.

## Benefits

- High-precision and high-speed laser processing can be realized
- Improvement of the overall machining productivity

## Ordering Information

Specification	Description
A02B-0329-S922	30i-LB Laser High-Speed Control 2
A02B-0330-S922	31i-LB Laser High-Speed Control 2

### Notice

Certain functions may require additional hardware, different CPU type or additional memory capacity or may cause compatibility issue with other functions. In case of doubt, contact your FANUC sales representative for additional information and support.

The information given in the FANUC manuals or original manufacturer documentation shall prevail. Technical data is subject to change without prior notice. No part of this document may be reproduced in any form. All rights reserved. © FANUC 2017

# 455

## Laser Functions

# Laser Oscillator Communication Control (FSSB Connection)

---

## Features

Third-party laser oscillators can be connected to the CNC by the laser interface unit. The laser interface unit itself is connected to the CNC unit via FSSB. This option is needed to control a third-party laser oscillator via FSSB. Laser output commands are transmitted to the laser interface unit and are output as analog signals.

## Benefits

- Controls third-party laser oscillators via FSSB high speed communication

## Ordering Information

Specification	Description
A02B-0323-C210	Laser Interface Unit - to Control 3rd Party Laser
A02B-0329-S928	30i-LB Laser Oscillator Communication Control (FSSB Connection) - to Control 3rd Party Laser via FSSB
A02B-0330-S928	30i-LB Laser Oscillator Communication Control (FSSB Connection) - to Control 3rd Party Laser via FSSB

### Notice

Certain functions may require additional hardware, different CPU type or additional memory capacity or may cause compatibility issue with other functions. In case of doubt, contact your FANUC sales representative for additional information and support.

The information given in the FANUC manuals or original manufacturer documentation shall prevail. Technical data is subject to change without prior notice. No part of this document may be reproduced in any form. All rights reserved. © FANUC 2017



# 456

## Laser Functions

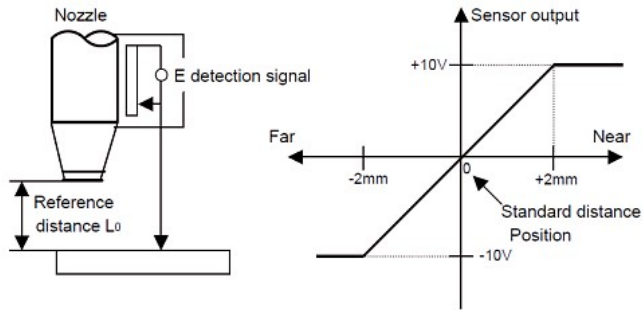

## Gap Control for Laser

### Features

When the laser cutting machine is equipped with a detector to measure the distance to the surface of the workpiece, it is possible with the Gap Control function to use an analog signal generated by this detector and send it to the CNC through a specified interface.

This signal is processed by the CNC and enables a precise gap control using the Z-axis of the CNC / machine.

### Benefits

- Control of the gap between nozzle and workpiece
- Improvement of the cutting quality

### Ordering Information

Specification	Description
A02B-0329-J817	30i-LB Gap Control
A02B-0330-J817	31i-LB Gap Control

#### Notice

Certain functions may require additional hardware, different CPU type or additional memory capacity or may cause compatibility issue with other functions. In case of doubt, contact your FANUC sales representative for additional information and support.

The information given in the FANUC manuals or original manufacturer documentation shall prevail. Technical data is subject to change without prior notice. No part of this document may be reproduced in any form. All rights reserved. © FANUC 2017

# 457

## Laser Functions

# Automatic Gap Control Axis Retract & Approaching Function

---

## Features

The Automatic Gap Control Axis Retraction and Approaching function enables an automatic retraction along the gap control axis under gap control during a positioning operation from the end point of the current cutting to the next cutting point along the X-/Y-axis.

It also enables to approach the workpiece along the gap control axis while approaching the next cutting point along the X-/Y-axis, without canceling the gap control mode, so the next cutting phase can be started.

## Benefits

- Increase the ease of use of the machine in nozzle approaching and retract cycles

## Ordering Information

Specification	Description
A02B-0329-S914	30i-LB Automatic Gap Control Axis Retraction and Approaching
A02B-0330-S914	31i-LB Automatic Gap Control Axis Retraction and Approaching

### Notice

Certain functions may require additional hardware, different CPU type or additional memory capacity or may cause compatibility issue with other functions. In case of doubt, contact your FANUC sales representative for additional information and support.

The information given in the FANUC manuals or original manufacturer documentation shall prevail. Technical data is subject to change without prior notice. No part of this document may be reproduced in any form. All rights reserved. © FANUC 2017

# 458

## Laser Functions

# Program Auto Restart

---

## Features

When a laser cutting process is interrupted (by a reset operation or a power failure) the Program Auto Restart function provides the possibility to restart the cutting from the interruption point.

## Benefits

- Fast restart of the production after an interruption
- Simplification of the programming of the restart process
- Overall increase of the machine productivity

## Ordering Information

Specification	Description
A02B-0329-S904	30i-LB Automatic Program Restart
A02B-0330-S904	31i-LB Automatic Program Restart

### Notice

Certain functions may require additional hardware, different CPU type or additional memory capacity or may cause compatibility issue with other functions. In case of doubt, contact your FANUC sales representative for additional information and support.

The information given in the FANUC manuals or original manufacturer documentation shall prevail. Technical data is subject to change without prior notice. No part of this document may be reproduced in any form. All rights reserved. © FANUC 2017

# 459

## Laser Functions

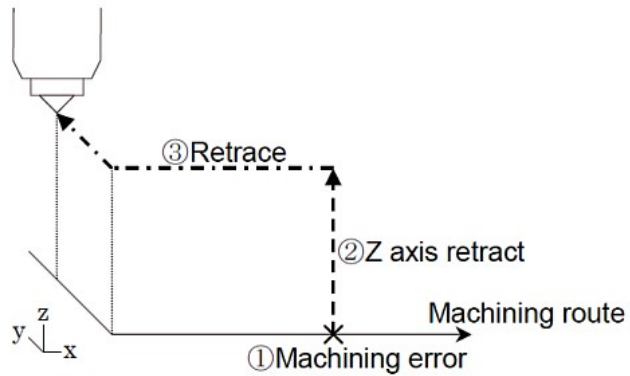

## Cutting Restart

### Features

The burning is generated in the laser cutting, and the cutting might not be able to be continued. In such a case, machining may be resumed by putting the machine back in the state in which it was before burning. This is done by a Processing Restart function.

If a machining error is detected, the cutting restart function moves the machine back to a specified position through the same path it had taken before the error occurred, while the laser beam is kept turned off.

When the machine gets back to the specified position, the cutting restart function again places the machine in an operable state and causes it to move forward to the position where it started going back.

### Benefits

- Simplification of the restart procedure of the machine in case of issue
- Simplification of the programming of the restart cycle
- Overall increase of the machine productivity

### Ordering Information

Specification	Description
A02B-0329-J887	30i-LB Cutting Restart
A02B-0330-J887	31i-LB Cutting Restart

### Notice

Certain functions may require additional hardware, different CPU type or additional memory capacity or may cause compatibility issue with other functions. In case of doubt, contact your FANUC sales representative for additional information and support.

The information given in the FANUC manuals or original manufacturer documentation shall prevail. Technical data is subject to change without prior notice. No part of this document may be reproduced in any form. All rights reserved. © FANUC 2017

# 460

## Laser Functions

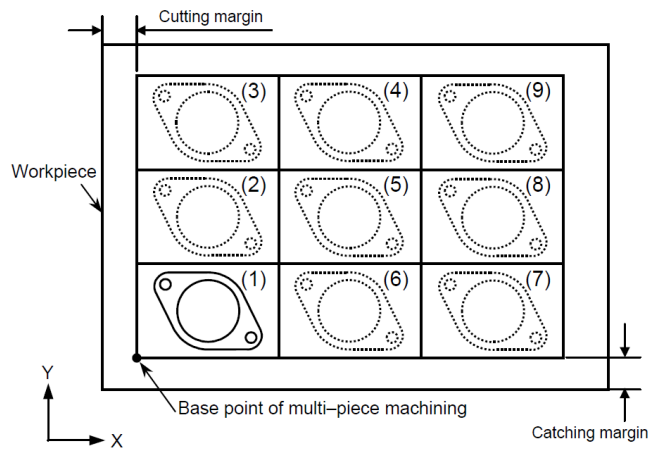

# Multi-Piece Machining

## Features

The Multi-piece Machining function enables several sheets of product with the same cut shape to be produced from a single sheet of material at a time by simple commands.

This function allows so called trial cutting that performs cutting only on a sheet of product from the cutting program for multi-piece machining by a simple setup method, therefore the cutting program can be easily checked before full machining.

## Benefits

- Reduction of the time from try out to production

## Ordering Information

Specification	Description
A02B-0329-J603	30i-LB Multi-Piece Machining
A02B-0330-J603	31i-LB Multi-Piece Machining

### Notice

Certain functions may require additional hardware, different CPU type or additional memory capacity or may cause compatibility issue with other functions. In case of doubt, contact your FANUC sales representative for additional information and support.

The information given in the FANUC manuals or original manufacturer documentation shall prevail. Technical data is subject to change without prior notice. No part of this document may be reproduced in any form. All rights reserved. © FANUC 2017

# 461

## Laser Functions

# Multi-Piece Machining End Area Command

---

## Features

With this function, the end area can be specified in Multi-piece machining comand blocks.

## Benefits

- Efficiency improvement of Multi-piece machining

## Ordering Information

Specification	Description
A02B-0329-S927	30i-LB Multi-Piece Machining End Area Command
A02B-0330-S927	31i-LB Multi-Piece Machining End Area Command

### Notice

Certain functions may require additional hardware, different CPU type or additional memory capacity or may cause compatibility issue with other functions. In case of doubt, contact your FANUC sales representative for additional information and support.

The information given in the FANUC manuals or original manufacturer documentation shall prevail. Technical data is subject to change without prior notice. No part of this document may be reproduced in any form. All rights reserved. © FANUC 2017

# 462

## Laser Functions

# Enhanced Buffer

---

## Features

This function enhances the number of reading blocks at cutter compensation (parameter No.19625). To find correct actual path, the intersecting point at the movement blocks is calculated with cutter compensation.

When the block that has no movement is commanded, eight blocks or less are read until the block which has the movement is found in this intersection calculation.

In the laser cutting, the piercing command, the cutting condition command, the assist gas command and the command with no movement might be consecutive. Even if the block which has no movement is continued 30 blocks or less, this function enables to maintain the offset vector and the beam route in cutter compensation mode and start-up mode as usual.

## Benefits

- Simplification of the programming
- Increase of the overall machine productivity

## Ordering Information

Specification	Description
A02B-0329-J611	30i-LB Buffer Expansion
A02B-0330-J611	31i-LB Buffer Expansion

### Notice

Certain functions may require additional hardware, different CPU type or additional memory capacity or may cause compatibility issue with other functions. In case of doubt, contact your FANUC sales representative for additional information and support.

The information given in the FANUC manuals or original manufacturer documentation shall prevail. Technical data is subject to change without prior notice. No part of this document may be reproduced in any form. All rights reserved. © FANUC 2017

# 463

## Laser Functions

# Attitude Control

---

## Features

When at least five controlled axes are specified and attitude control is also specified, control can be applied to the attitude of the nozzle with the fourth and fifth axes used as rotational axes.

When using this function, the laser machine tool can be use as a three-dimensional machine tool.

## Benefits

- Simplification of the programming
- Overall improvement of the machine productivity

## Ordering Information

Specification	Description
A02B-0329-J827	30i-LB Attitude Control

### Notice

Certain functions may require additional hardware, different CPU type or additional memory capacity or may cause compatibility issue with other functions. In case of doubt, contact your FANUC sales representative for additional information and support.

The information given in the FANUC manuals or original manufacturer documentation shall prevail. Technical data is subject to change without prior notice. No part of this document may be reproduced in any form. All rights reserved. © FANUC 2017



# 464

## Laser Functions

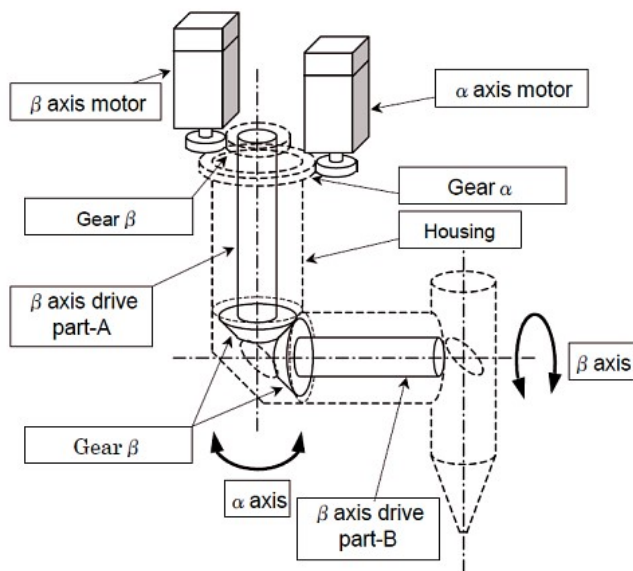

## Interaction Control

### Features

In nozzle attitude control, as shown in the diagram of the axis configuration of the nozzle head, the  $\beta$  axis motor is arranged around the Z axis. In the case of a structure which transmits by gear, if the  $\alpha$  axis is commanded, the housing rotates and the nozzle rotates around the Z axis.

However, simultaneously at this time gear  $\beta$  must rotate around gear  $\alpha$ . This movement results in the nozzle being rotated by the  $\beta$  axis.

Namely, if the  $\alpha$  axis rotates by an  $\alpha$  axis command, a rotational operation simultaneously occurs at the  $\beta$  axis.

Interaction control is the function to automatically generate commands in the  $\beta$  axis of the same amount as the  $\alpha$  axis commands in order to cancel the rotational operation of the  $\beta$  axis for a nozzle head of axis configuration such that the  $\beta$  axis rotates by the  $\alpha$  axis commands. The command polarity can be selected by parameter.

### Benefits

- Simplification of the programming
- Overall increase of the machine productivity

### Ordering Information

Specification	Description
A02B-0329-J864	30i-LB Interaction Control

#### Notice

Certain functions may require additional hardware, different CPU type or additional memory capacity or may cause compatibility issue with other functions. In case of doubt, contact your FANUC sales representative for additional information and support.

The information given in the FANUC manuals or original manufacturer documentation shall prevail. Technical data is subject to change without prior notice. No part of this document may be reproduced in any form. All rights reserved. © FANUC 2017

# 465

## Laser Functions

# W-Axis Gap Control

---

## Features

W axis gap control function is necessary for gap control using the second gap control axis.

## Benefits

- When W axis gap control function is effective, the gap control axis can select either of the first gap control axis or the second gap control axis.

## Ordering Information

Specification	Description
A02B-0329-J825	30i-LB W-Axis Gap Control

### Notice

Certain functions may require additional hardware, different CPU type or additional memory capacity or may cause compatibility issue with other functions. In case of doubt, contact your FANUC sales representative for additional information and support.

The information given in the FANUC manuals or original manufacturer documentation shall prevail. Technical data is subject to change without prior notice. No part of this document may be reproduced in any form. All rights reserved. © FANUC 2017

# 466

## Laser Functions

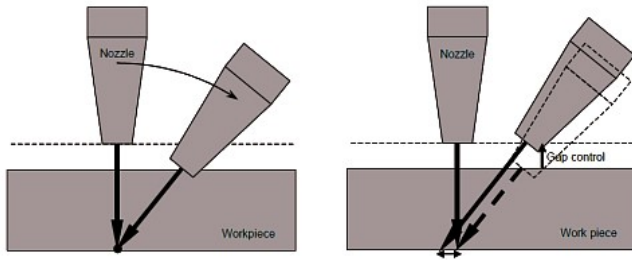

## Bevel Cutting Compensation Function

### Features

In the bevel cutting that uses the inclination to the work cutting side, the laser beam irradiation point specified by the program might become a work bottom.

Therefore, the laser beam irradiation point as a nozzle tip point in the nozzle length compensation function, operate the nozzle tip fixing mode, bevel angle changes, the nozzle might collide with the workpiece surface (left figure).

To avoid this collision, the gap control is used, the nozzle is done gap control in the vertical direction, the tracks error margin in the work bottom occurs (right figure).

By compensating the nozzle length automatically according to the bevel angle in the nozzle tip fixing mode, the bevel cutting compensation function loses the tracks error margin without the nozzle colliding with the workpiece surface.

### Benefits

- Increase of the cutting capabilities of the machine
- Avoidance of the collision between the nozzle and the working table

### Ordering Information

Specification	Description
A02B-0329-S909	30i-LB Bevel Cutting Compensation Function

#### Notice

Certain functions may require additional hardware, different CPU type or additional memory capacity or may cause compatibility issue with other functions. In case of doubt, contact your FANUC sales representative for additional information and support.

The information given in the FANUC manuals or original manufacturer documentation shall prevail. Technical data is subject to change without prior notice. No part of this document may be reproduced in any form. All rights reserved. © FANUC 2017

# 467

## Laser Functions

# Punch Press Function for Compound Cutting

## Features

When the function for Punch Press is activated and parameter ALA (No.16242#0) is 1, the punch press function becomes effective. As a result, the function of Series 30i/31i-PB CNC can be used also with Series 30i/31i-LB CNC.

When the punch press function is effective, the punch mode that does the punch press processing and the laser mode that does laser processing become possible. Each mode is switched by specified M code.

In the program, the punch press processing and the laser processing can be alternately done by one program when specified M code of each mode in the first block of the punch press processing and the laser processing.

## Benefits

- Increase of the capabilities of the laser CNC to punch press

## Ordering Information

Specification	Description
A02B-0329-R815	30i-LB Punch Press Function
A02B-0330-R815	31i-LB Punch Press Function

### Notice

Certain functions may require additional hardware, different CPU type or additional memory capacity or may cause compatibility issue with other functions. In case of doubt, contact your FANUC sales representative for additional information and support.

The information given in the FANUC manuals or original manufacturer documentation shall prevail. Technical data is subject to change without prior notice. No part of this document may be reproduced in any form. All rights reserved. © FANUC 2017

# 468

## Functions

# Gas Cutting Machine Functions

---

This section of the catalogue contains the functions related to Gas Cutting machines.

Some of the functions detailed in the catalogue:

- Torch swing
- In- acceleration / deceleration
- Corner control
- Tool offset B
- Etc.

### Notice

Certain functions may require additional hardware, different CPU type or additional memory capacity or may cause compatibility issue with other functions. In case of doubt, contact your FANUC sales representative for additional information and support.

The information given in the FANUC manuals or original manufacturer documentation shall prevail. Technical data is subject to change without prior notice. No part of this document may be reproduced in any form. All rights reserved. © FANUC 2017

# 469

## Gas Cutting Machine Functions

# Functions for Gas Cutting Machine

---

## Features

Options for the gas cutting machine functions by controller.

## Ordering Information

Specification	Description
A02B-0323-R535	30i-B Functions for Gas Cutting Machine
A02B-0326-R535	31i-B5 Functions for Gas Cutting Machine
A02B-0327-R535	31i-B Functions for Gas Cutting Machine

### Notice

Certain functions may require additional hardware, different CPU type or additional memory capacity or may cause compatibility issue with other functions. In case of doubt, contact your FANUC sales representative for additional information and support.

The information given in the FANUC manuals or original manufacturer documentation shall prevail. Technical data is subject to change without prior notice. No part of this document may be reproduced in any form. All rights reserved. © FANUC 2017

# 470

## Gas Cutting Machine Functions

# Automatic Exact Stop Check

## Features

The Automatic Exact Stop Check function checks the corner inner angle between successive blocks specifying linear interpolation (G01) or circular interpolation (G02, G03) and perform an exact stop automatically between the blocks if the angle is equal to or less than a set critical angle.

## Benefits

- Simplification of the programming
- Improvement of the overall machining productivity

## Ordering Information

Specification	Description
A02B-0323-R505	30i-B Automatic Exact Stop Check
A02B-0326-R505	31i-B5 Automatic Exact Stop Check
A02B-0327-R505	31i-B Automatic Exact Stop Check

### Notice

Certain functions may require additional hardware, different CPU type or additional memory capacity or may cause compatibility issue with other functions. In case of doubt, contact your FANUC sales representative for additional information and support.

The information given in the FANUC manuals or original manufacturer documentation shall prevail. Technical data is subject to change without prior notice. No part of this document may be reproduced in any form. All rights reserved. © FANUC 2017

# 471

## Gas Cutting Machine Functions

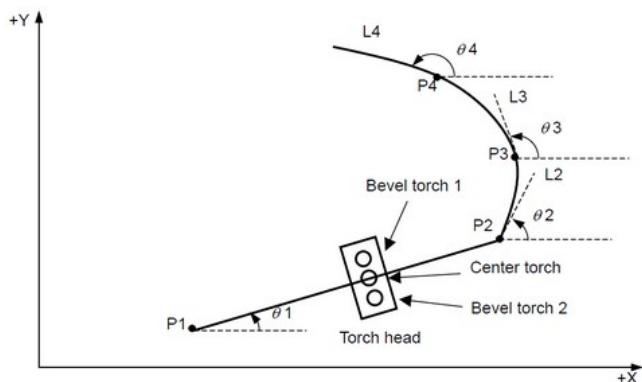

## Torch Swing for Gas Cutting Machine

### Features

For beveling using a torch head with a bevel torch (hereinafter simply referred to as a torch head), the torch head generally needs to be positioned in the normal direction to a specified straight line or arc at all times. This function automatically controls the torch head swing control axis (hereinafter referred to as the torch swing axis) to position the torch head in the normal direction to a specified straight line or arc.

For positioning in the normal direction to a straight line, the torch control axis is fed at a constant speed in the normal direction to the straight line according to linear interpolation execution. For positioning in the normal direction to an arc, the torch control axis is positioned in the momentarily changing normal direction to the arc according to circular interpolation execution.

### Benefits

- Addition of Torch Swing control for gas cutting process
- Simplification of the programming
- Improvement of the overall machining productivity

### Ordering Information

Specification	Description
A02B-0323-R506	30i-B Torch Swing for Gas Cutting Machine
A02B-0326-R506	31i-B5 Torch Swing for Gas Cutting Machine
A02B-0327-R506	31i-B Torch Swing for Gas Cutting Machine

### Notice

Certain functions may require additional hardware, different CPU type or additional memory capacity or may cause compatibility issue with other functions. In case of doubt, contact your FANUC sales representative for additional information and support.

The information given in the FANUC manuals or original manufacturer documentation shall prevail. Technical data is subject to change without prior notice. No part of this document may be reproduced in any form. All rights reserved. © FANUC 2017



# 472

## Gas Cutting Machine Functions

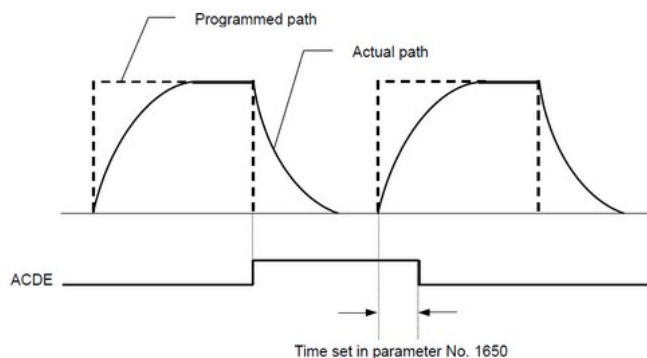

## In-Acceleration/Deceleration Signal

### Features

The In- Acceleration / Deceleration Signal function During deceleration in a block for cutting feed, the in-acceleration/ deceleration signal is output to the machine.

### Benefits

- Simplification of the programming
- Improvement of the overall machining productivity

### Ordering Information

Specification	Description
A02B-0323-R519	30i-B In-Acceleration / Deceleration Signal
A02B-0326-R519	31i-B5 In-Acceleration / Deceleration Signal
A02B-0327-R519	31i-B In-Acceleration / Deceleration Signal
A02B-0328-R519	FS 32i-B In-Acceleration / Deceleration Signal
A02B-0340-R519	0i-MF In-Acceleration / Deceleration Signal

### Notice

Certain functions may require additional hardware, different CPU type or additional memory capacity or may cause compatibility issue with other functions. In case of doubt, contact your FANUC sales representative for additional information and support.

The information given in the FANUC manuals or original manufacturer documentation shall prevail. Technical data is subject to change without prior notice. No part of this document may be reproduced in any form. All rights reserved. © FANUC 2017

# 473

## Gas Cutting Machine Functions

### Gentle Curve Cutting

---

#### Features

With the Gentle Curve Cutting function, if the V-axis is added as an axis parallel to the Y-axis, the V-axis in the gentle curve cutting cancel mode (G13) and a command for the Y-axis alone is assumed to be specified for the V-axis as well and enables movement also on the V-axis.

In the gentle curve cutting mode (G12), a command for the Y-axis is valid for the Y-axis alone and a command for the V-axis is valid for the V-axis alone.

#### Benefits

- Simplification of the programming
- Improvement of the overall machining productivity

#### Ordering Information

Specification	Description
A02B-0323-R504	30i-B Gentle Curve Cutting
A02B-0326-R504	31i-B5 Gentle Curve Cutting
A02B-0327-R504	31i-B Gentle Curve Cutting

#### Notice

Certain functions may require additional hardware, different CPU type or additional memory capacity or may cause compatibility issue with other functions. In case of doubt, contact your FANUC sales representative for additional information and support.

The information given in the FANUC manuals or original manufacturer documentation shall prevail. Technical data is subject to change without prior notice. No part of this document may be reproduced in any form. All rights reserved. © FANUC 2017

# 474

## Gas Cutting Machine Functions

### Corner Control by Feedrate

---

#### Features

If a block for cutting feed is followed by another block for cutting feed, the number of accumulated pulses in the automatic acceleration / deceleration circuit of each axis in the block being executed is assumed to be 0 and machining proceeds to the next block when the feedrate being decelerated on each axis with the automatic acceleration / deceleration circuit has decreased to or below the feedrate set in parameter.

#### Benefits

- Simplification of the programming
- Improvement of the overall machining productivity

#### Ordering Information

Specification	Description
A02B-0323-R508	30i-B Corner Control by Feedrate
A02B-0326-R508	31i-B5 Corner Control by Feedrate
A02B-0327-R508	31i-B Corner Control by Feedrate

#### Notice

Certain functions may require additional hardware, different CPU type or additional memory capacity or may cause compatibility issue with other functions. In case of doubt, contact your FANUC sales representative for additional information and support.

The information given in the FANUC manuals or original manufacturer documentation shall prevail. Technical data is subject to change without prior notice. No part of this document may be reproduced in any form. All rights reserved. © FANUC 2017

# 475

## Gas Cutting Machine Functions

### Tool Offset B

---

#### Features

With the Tool Offset B function G43H\_ or G44H\_ command, the tool offset not affected by mirror image can be applied.

With the G49 command, the tool offset can be canceled without being affected by the mirror image. The offset axes are the first axis and second axis for the plane selection.

#### Benefits

- Simplification of the programming
- Improvement of the overall machining productivity

#### Ordering Information

Specification	Description
A02B-0323-R507	30i-B Tool Position Offset B
A02B-0323-S616	30i-B Tool Offset Memory B
A02B-0326-R507	31i-B5 Tool Position Offset B
A02B-0326-S616	31i-B5 Tool Offset Memory B
A02B-0327-R507	31i-B Tool Position Offset B
A02B-0327-S616	31i-B Tool Offset Memory B
A02B-0328-S616	32i-B Tool Offset Memory B
A02B-0333-S616	35i-B Tool Offset Memory B

#### Notice

Certain functions may require additional hardware, different CPU type or additional memory capacity or may cause compatibility issue with other functions. In case of doubt, contact your FANUC sales representative for additional information and support.

The information given in the FANUC manuals or original manufacturer documentation shall prevail. Technical data is subject to change without prior notice. No part of this document may be reproduced in any form. All rights reserved. © FANUC 2017

# 476

## Gas Cutting Machine Functions

### Gap Control

---

#### Features

On machines which are equipped with a distance measurement sensor, the Gap Control function controls the motion of the Z-axis to keep the distance between the sensor and the workpiece constant.

An Analog Input Module of I/O Link is necessary to use this function.

#### Benefits

- Improve the quality of the cutting edge

#### Ordering Information

Specification	Description
A02B-0323-R636	30i-B Gap Control
A02B-0326-R636	31i-B5 Gap Control
A02B-0327-R636	31i-B Gap Control
A02B-0328-R636	FS 32i-B Gap Control
A02B-0340-R636	0i-MF Gap Control

#### Notice

Certain functions may require additional hardware, different CPU type or additional memory capacity or may cause compatibility issue with other functions. In case of doubt, contact your FANUC sales representative for additional information and support.

The information given in the FANUC manuals or original manufacturer documentation shall prevail. Technical data is subject to change without prior notice. No part of this document may be reproduced in any form. All rights reserved. © FANUC 2017

# 477

## Functions

# Editing Operation

---

This section of the catalogue contains the functions related to the Editing Operations on the CNC.

Some of the functions detailed in the catalogue:

- Size of parts program
- Number of programs
- Encryption
- Background editing
- Etc.

### Notice

Certain functions may require additional hardware, different CPU type or additional memory capacity or may cause compatibility issue with other functions. In case of doubt, contact your FANUC sales representative for additional information and support.

The information given in the FANUC manuals or original manufacturer documentation shall prevail. Technical data is subject to change without prior notice. No part of this document may be reproduced in any form. All rights reserved. © FANUC 2017

# 478

## Editing Operation

# Part Program Storage Size

## Features

The Part Program Storage is the amount of space available for the operator or user of the CNC to store CNC Part Programs.

The size of the program memory can be incremented to up to 8MB, depending on the CNC model.

Refer to the ordering information table for the sizes available.

## Ordering Information

Specification	Description
A02B-0323-J944	30i-B Part Program Memory, 128 kB
A02B-0323-J945	30i-B Part Program Memory, 256 kB
A02B-0323-J946	30i-B Part Program Memory, 512 kB
A02B-0323-J947	30i-B Part Program Memory, 1 MB
A02B-0323-J948	30i-B Part Program Memory, 2 MB
A02B-0323-J949	30i-B Part Program Memory, 4 MB
A02B-0323-J959	30i-B Part Program Memory, 8 MB
A02B-0326-J944	31i-B5 Part Program Memory, 128 kB
A02B-0326-J945	31i-B5 Part Program Memory, 256 kB
A02B-0326-J946	31i-B5 Part Program Memory, 512 kB
A02B-0326-J947	31i-B5 Part Program Memory, 1 MB
A02B-0326-J948	31i-B5 Part Program Memory, 2 MB
A02B-0326-J949	31i-B5 Part Program Memory, 4 MB
A02B-0326-J959	31i-B5 Part Program Memory, 8 MB
A02B-0327-J944	31i-B Part Program Memory, 128 kB
A02B-0327-J945	31i-B Part Program Memory, 256 kB
A02B-0327-J946	31i-B Part Program Memory, 512 kB
A02B-0327-J947	31i-B Part Program Memory, 1 MB
A02B-0327-J948	31i-B Part Program Memory, 2 MB
A02B-0327-J949	31i-B Part Program Memory, 4 MB
A02B-0327-J959	31i-B Part Program Memory, 8 MB
A02B-0328-J943	32i-B Part Program Memory, 64 kB
A02B-0328-J944	32i-B Part Program Memory, 128 kB
A02B-0328-J945	32i-B Part Program Memory, 256 kB
A02B-0328-J946	32i-B Part Program Memory, 512 kB
A02B-0328-J947	32i-B Part Program Memory, 1 MB

### Notice

Certain functions may require additional hardware, different CPU type or additional memory capacity or may cause compatibility issue with other functions. In case of doubt, contact your FANUC sales representative for additional information and support.

The information given in the FANUC manuals or original manufacturer documentation shall prevail. Technical data is subject to change without prior notice. No part of this document may be reproduced in any form. All rights reserved. © FANUC 2017

# 479

Specification	Description
A02B-0328-J948	32i-B Part Program Memory, 2 MB
A02B-0328-J949	32i-B Part Program Memory, 4 MB
A02B-0328-J959	32i-B Part Program Memory, 8 MB
A02B-0333-J943	35i-B Part Program Memory, 64 kB
A02B-0333-J944	35i-B Part Program Memory, 128 kB
A02B-0333-J945	35i-B Part Program Memory, 256 kB
A02B-0333-J946	35i-B Part Program Memory, 512 kB
A02B-0333-J947	35i-B Part Program Memory, 1 MB
A02B-0334-J943	PM i-A Part Program Memory, 64 kB
A02B-0334-J944	PM i-A Part Program Memory, 128 kB
A02B-0334-J945	PM i-A Part Program Memory, 256 kB
A02B-0334-J946	PM i-A Part Program Memory, 512 kB
A02B-0334-J947	PM i-A Part Program Memory, 1 MB
A02B-0339-J948	0i-TF Part Program Storage Size 2 MB
A02B-0340-J948	0i-MF Part Program Storage Size 2 MB

## Notice

Certain functions may require additional hardware, different CPU type or additional memory capacity or may cause compatibility issue with other functions. In case of doubt, contact your FANUC sales representative for additional information and support.

The information given in the FANUC manuals or original manufacturer documentation shall prevail. Technical data is subject to change without prior notice. No part of this document may be reproduced in any form. All rights reserved. © FANUC 2017



# 480

## Editing Operation

# Number of Registered Programs

## Features

The number of registered programs is the total number of programs, subject to the availability of memory space, which can be stored in the CNC. The number varies with the total size of part program storage. The Registered Program Expansion option increases the number of programs according to the table below:

Part Program Storage Length	Expansion 1	Expansion 2
64 KByte	120	--
128 KByte	250	--
256 KByte	500	--
512 KByte	1000	--
1MByte	1000	2000
2MByte	1000	4000
4MByte	1000	4000
8MByte	1000	4000

## Benefits

- Allows better organisation of complex part programs into subroutines
- Quick access to a large number of different programs for shop floor programming

## Ordering Information

Specification	Description
A02B-0323-J953	30i-B Registered Program Expansion 1, Max. 1000 Programs
A02B-0323-J954	30i-B Registered Program Expansion 2, Max. 4000 Programs
A02B-0326-J953	31i-B5 Registered Program Expansion 1, Max. 1000 Programs
A02B-0326-J954	31i-B5 Registered Program Expansion 2, Max. 4000 Programs
A02B-0327-J953	31i-B Registered Program Expansion 1, Max. 1000 Programs
A02B-0327-J954	31i-B Registered Program Expansion 2, Max. 4000 Programs
A02B-0328-J953	32i-B Registered Program Expansion 1, Max. 1000 Programs
A02B-0328-J954	32i-B Registered Program Expansion 2, Max. 4000 Programs
A02B-0333-J953	35i-B Registered Program Expansion 1, Max. 1000 Programs
A02B-0334-J953	PM i-A Registered Program Expansion 1
A02B-0339-J953	0i-TF Number of Registered Programs, Expansion 1
A02B-0340-J953	0i-MF Number of Registered Programs, Expansion 1

### Notice

Certain functions may require additional hardware, different CPU type or additional memory capacity or may cause compatibility issue with other functions. In case of doubt, contact your FANUC sales representative for additional information and support.

The information given in the FANUC manuals or original manufacturer documentation shall prevail. Technical data is subject to change without prior notice. No part of this document may be reproduced in any form. All rights reserved. © FANUC 2017

# 481

## Editing Operation

# Key and Program Encryption

## Features

The Key and Program Encryption function protects part programs from unauthorized use. Program contents can be protected by setting parameters for encryption and for the program security range.

- When the password and security range parameters are specified, the display, editing, and input/output operations are disabled for the programs within the security range.
- The programs in the security range can be encrypted before being output. Once encrypted, the programs cannot be decrypted. In addition, encrypted programs can be input directly.

## Benefits

- Increase of the safety and security of the machine operation

## Ordering Information

Specification	Description
A02B-0323-J778	30i-B Key and Program Encryption
A02B-0326-J778	31i-B5 Key and Program Encryption
A02B-0327-J778	31i-B Key and Program Encryption
A02B-0328-J778	32i-B Key and Program Encryption
A02B-0339-J778	0i-TF Key and Program Encryption
A02B-0340-J778	0i-MF Key and Program Encryption

### Notice

Certain functions may require additional hardware, different CPU type or additional memory capacity or may cause compatibility issue with other functions. In case of doubt, contact your FANUC sales representative for additional information and support.

The information given in the FANUC manuals or original manufacturer documentation shall prevail. Technical data is subject to change without prior notice. No part of this document may be reproduced in any form. All rights reserved. © FANUC 2017

# 482

## Editing Operation

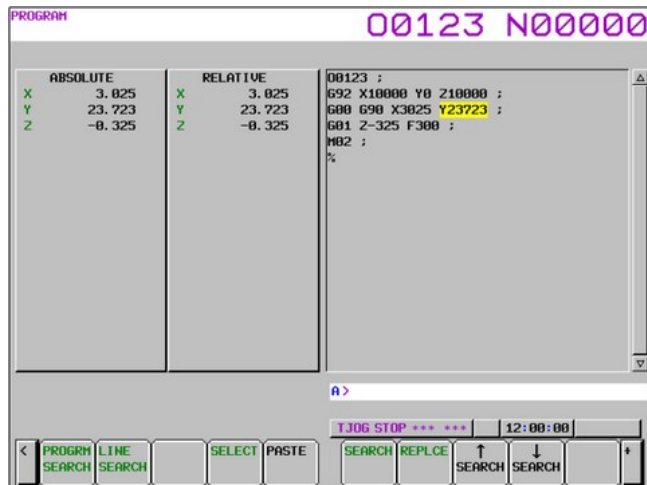

### Notice

Certain functions may require additional hardware, different CPU type or additional memory capacity or may cause compatibility issue with other functions. In case of doubt, contact your FANUC sales representative for additional information and support.

The information given in the FANUC manuals or original manufacturer documentation shall prevail. Technical data is subject to change without prior notice. No part of this document may be reproduced in any form. All rights reserved. © FANUC 2017

# Playback

## Features

Playback is a function that allows the operator to teach the CNC a part program in JOG or HANDLE mode.

In these modes, a machine position along the X, Y and Z axes, obtained by manual operation, is stored in memory as a program position to create a program. The words other than X, Y and Z, which include O, N, G, R, F, C, M, S, T, P, Q, and EOB, can be stored in memory in the same way as in EDIT mode.

This function is a basic function in FANUC Series 0i-F.

## Benefits

- Reduce set up time
- Save repeated motions in memory by capturing machine position of manual motions, G, M, S, T can also be added
- Great tool for fixture preparation such as facing a fixture/jaws

## Ordering Information

Specification	Description
A02B-0323-J879	30i-B Playback
A02B-0326-J879	31i-B5 Playback
A02B-0327-J879	31i-B Playback
A02B-0328-J879	32i-B Playback

# 483

## Editing Operation

# Machining Time Stamp

---

## Features

The execution times of the most recently executed ten programs can be displayed in hours, minutes, and seconds.

The calculated machining time can be inserted as a comment of the program to check the machining time on the program directory screen.

Run Hour and Parts Count Display Function is required.

## Benefits

- Simplification of production efficiency tracking

## Ordering Information

Specification	Description
A02B-0323-J964	30i-B Machine Time Stamp
A02B-0326-J964	31i-B5 Machine Time Stamp
A02B-0327-J964	31i-B Machine Time Stamp
A02B-0328-J964	32i-B Machining Time Stamp
A02B-0339-J964	0i-TF Machining Time Stamp
A02B-0340-J964	0i-MF Machining Time Stamp

### Notice

Certain functions may require additional hardware, different CPU type or additional memory capacity or may cause compatibility issue with other functions. In case of doubt, contact your FANUC sales representative for additional information and support.

The information given in the FANUC manuals or original manufacturer documentation shall prevail. Technical data is subject to change without prior notice. No part of this document may be reproduced in any form. All rights reserved. © FANUC 2017

# 484

## Editing Operation

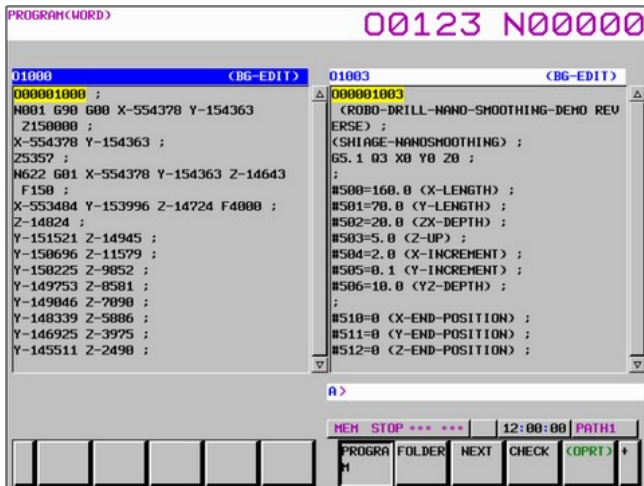

### Notice

Certain functions may require additional hardware, different CPU type or additional memory capacity or may cause compatibility issue with other functions. In case of doubt, contact your FANUC sales representative for additional information and support.

The information given in the FANUC manuals or original manufacturer documentation shall prevail. Technical data is subject to change without prior notice. No part of this document may be reproduced in any form. All rights reserved. © FANUC 2017

# Background Editing

## Features

While a program is being executed, another program may be edited. Such an edit operation is called Background Editing (BG editing). Background Editing can be performed in exactly the same way as ordinary editing (foreground editing).

This function is a basic function in FANUC Series 0i-F.

## Benefits

- Edit part programs, other than the currently active program, while the machine tool is operating
- Non-active part programs for future jobs may be safely edited in background on the CNC while the machine tool is running the production program in foreground

## Benefits

- Simplifies the operation of the machine
- Improves machining productivity

## Ordering Information

Specification	Description
A02B-0323-J956	30i-B Multi-Part Program Editing (Background Editing)
A02B-0326-J956	31i-B5 Multi-Part Program Editing (Background Editing)
A02B-0327-J956	31i-B Multi-Part Program Editing (Background Editing)
A02B-0328-J956	32i-B Multi-Part Program Editing (Background Editing)

# 485

## Editing Operation

# Memory Card Program Entry Count Extension

## Features

This function extends the number of part programs and folders that may be formatted onto a memory card for direct operation and/or editing. The standard allowance of 63 programs and folders may be extended up to a maximum of 1000.

This feature is only used when the PC Tool for Memory Card Program Operation/ Editing software is used to format part program text files to a memory card, for use via the PCMCIA card slot. This feature is not applicable when using the memory card for basic READ, PUNCH or DNC operations with part programs or input/output of maintenance files.

## Benefits

- Allows up to 1000 folders and programs to be used.
- Use of folders can greatly assist organization of files on memory card

## Ordering Information

Specification	Description
A02B-0323-S995	30i-B Memory Card Program, Entry Count Extension, Max. 1000 Programs
A02B-0326-S995	31i-B5 Memory Card Program, Entry Count Extension, Max. 1000 Programs
A02B-0327-S995	31i-B Memory Card Program, Entry Count Extension, Max. 1000 Programs
A02B-0328-S995	32i-B Memory Card Program, Entry Count Extension, Max. 1000 Programs
A02B-0339-S995	0i-TF Memory Card Program Entry Count Extension
A02B-0340-S995	0i-MF Memory Card Program Entry Count Extension

### Notice

Certain functions may require additional hardware, different CPU type or additional memory capacity or may cause compatibility issue with other functions. In case of doubt, contact your FANUC sales representative for additional information and support.

The information given in the FANUC manuals or original manufacturer documentation shall prevail. Technical data is subject to change without prior notice. No part of this document may be reproduced in any form. All rights reserved. © FANUC 2017

# 486

## Editing Operation

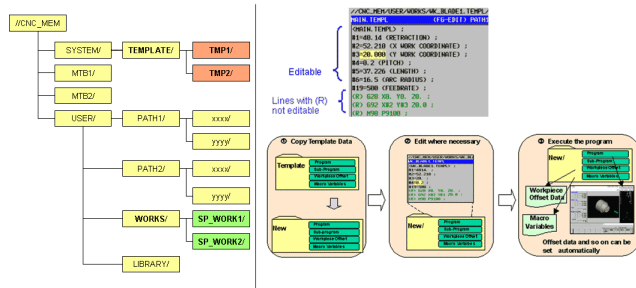

# Template Program Function

## Features

The Machining Data Management Function management function provides the following features:

- Easy and Fast Creation of Complex Part Programs
- Combination of Machining Data and Part Programs

Manages program data such as

- Offsets
- Parameter
- Macro Variables
- Program Template

Folder based program structure

- Template Folder
- Machining Folder

Adjustable Data

- Parameter (G10 L52; ...)
- Pitch Error Compensation data (G10 L50;...)
- Workpiece Origin Offsets (G10 L20 P...)
  - External workpiece offset (G10 L2 P...)
  - Additional workpiece coordinate system (G10 P0 ...)
- Tool Management Data
  - Modifying, Deleting (G10 L75 P...)
  - Register, Modify, Delete Cartridge Management Table (G10 L76 P...)
  - Offset data for Lathe and Machining
  - ...
- Custom Macro Variables (#xxx = yyy;)

Remarks

To use this function, the 8-level data protection function is also necessary.

## Benefits

- Simplifies the operation of the machine
- Improves machining productivity

### Notice

Certain functions may require additional hardware, different CPU type or additional memory capacity or may cause compatibility issue with other functions. In case of doubt, contact your FANUC sales representative for additional information and support.

The information given in the FANUC manuals or original manufacturer documentation shall prevail. Technical data is subject to change without prior notice. No part of this document may be reproduced in any form. All rights reserved. © FANUC 2017

# 487

## Ordering Information

Specification	Description
A02B-0323-R561	30i-B Template Program Function (Machining Data Management Function)
A02B-0326-R561	31i-B5 Template Program Function (Machining Data Management Function)
A02B-0327-R561	31i-B Template Program Function (Machining Data Management Function)
A02B-0328-R561	32i-B Template Program Function (Machining Data Management Function)

### Notice

Certain functions may require additional hardware, different CPU type or additional memory capacity or may cause compatibility issue with other functions. In case of doubt, contact your FANUC sales representative for additional information and support.

The information given in the FANUC manuals or original manufacturer documentation shall prevail. Technical data is subject to change without prior notice. No part of this document may be reproduced in any form. All rights reserved. © FANUC 2017



# 488

## Editing Operation

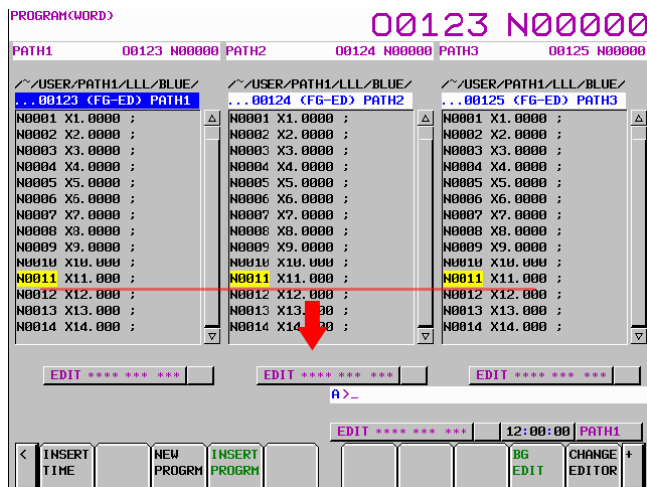

### Notice

Certain functions may require additional hardware, different CPU type or additional memory capacity or may cause compatibility issue with other functions. In case of doubt, contact your FANUC sales representative for additional information and support.

The information given in the FANUC manuals or original manufacturer documentation shall prevail. Technical data is subject to change without prior notice. No part of this document may be reproduced in any form. All rights reserved. © FANUC 2017

# Multi-Path Editing Function

## Features

In the simultaneous multi-path editing function, when the program of selected path is scrolled, other path programs that are displayed on the same screen can be scrolled simultaneously.

In this function, there are the synchronous scroll mode which scrolls all programs simultaneously displayed on the one screen and the single scroll mode which scrolls one program of the selected path. It is possible to switch between the synchronous scroll mode and the single scroll mode by the soft key operation easily.

In a synchronous scroll mode, when the cursor moves to the waiting M-code, the scroll of its path stops automatically until the cursor of the other path move to the same waiting M-code. So it is possible to edit the program confirming the waiting of each path program.

Moreover, the cursor of all paths in simultaneous editing can be moved to specified waiting M-code at a time by synchronous search.

## Benefits

- Simplifies the operation of the machine
- Improves machining productivity

## Ordering Information

Specification	Description
A02B-0323-R615	30i-B Multi-Path Editing Function
A02B-0326-R615	31i-B5 Multi-Path Editing Function
A02B-0327-R615	31i-B Multi-Path Editing Function
A02B-0328-R615	32i-B Multi-Path Editing Function
A02B-0339-R615	0i-TF Multi-Path Editing Function
A02B-0340-R615	0i-MF Multi-Path Editing Function

# 489

## Editing Operation

# High-Speed Program Management

## Features

The High-Speed Program Management function can be used to ease the work when the operator is working on many machining programs at the same time.

The function allows to save all programs at once as it also allows to erase all the programs.

This function is a basic function in FANUC Series 0i-F.

## Benefits

- Addition of the "All" function to the save or erase function
- Simplification of the programming
- Improvement of the overall machining productivity

## Ordering Information

Specification	Description
A02B-0323-R647	30i-B High-Speed Program Management
A02B-0326-R647	31i-B5 High-Speed Program Management
A02B-0327-R647	31i-B High-Speed Program Management
A02B-0328-R647	32i-B High-Speed Program Management

### Notice

Certain functions may require additional hardware, different CPU type or additional memory capacity or may cause compatibility issue with other functions. In case of doubt, contact your FANUC sales representative for additional information and support.

The information given in the FANUC manuals or original manufacturer documentation shall prevail. Technical data is subject to change without prior notice. No part of this document may be reproduced in any form. All rights reserved. © FANUC 2017

# 490

## Editing Operation

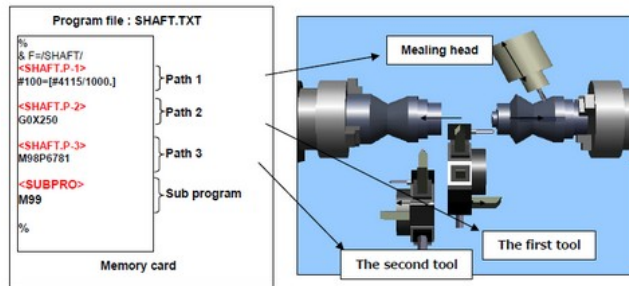

Example of complex machining center (One milling head and two tool posts)

## Multi-Path Program Management Function

### Features

The multi-path lathe and the complex machine that have several turrets or heads machine workpieces using two or more machining programs. With this function, multi-path programs, offset data, and parameters, etc. for one part machining are managed together by a folder.

In addition, batch creation, batch selection, simultaneous editing and batch Input / Output of the programs are enabled. As a result, this function makes it easy to handle such multi-path programs.

### Benefits

- Simplifies the operation of the machine
- Improves machining productivity

### Ordering Information

Specification	Description
A02B-0323-R684	30i-B Multi-Path Program Management Function
A02B-0326-R684	31i-B5 Multi-Path Program Management Function
A02B-0327-R684	31i-B Multi-Path Program Management Function
A02B-0328-R684	32i-B Multi-Path Program Management Function

### Notice

Certain functions may require additional hardware, different CPU type or additional memory capacity or may cause compatibility issue with other functions. In case of doubt, contact your FANUC sales representative for additional information and support.

The information given in the FANUC manuals or original manufacturer documentation shall prevail. Technical data is subject to change without prior notice. No part of this document may be reproduced in any form. All rights reserved. © FANUC 2017

# 491

## Editing Operation



# Cycle Time Estimate for iHMI

## Features

Cycle Time Estimate for iHMI is a function that can quickly estimate the execution cycle time of an NC program. It delivers estimations for cutting and rapid traverse times, time spent on the execution of auxiliary codes (e. g. M codes), as well as cutting and rapid traverse travel distances. Cycle Time Estimate for iHMI is an extension for the FANUC iHMI operation interface.

The accuracy of the estimation is higher than estimations made with 3rd party software. All estimations are calculated in consideration of the real machine's acceleration and deceleration. It is possible to estimate the machining time of complex programs, for example programs for 5-axis machining.

Panel iH Pro is necessary to use this function.

## Benefits

- Decrease processing time by optimizing programs
- Improve the utilization of your machines by enhanced and reliable machine schedule planning

## Ordering Information

Specification	Description
A02B-0323-R902	30i-B Cycle Time Estimate Function for iHMI
A02B-0326-R902	31i-B5 Cycle Time Estimate Function for iHMI
A02B-0327-R902	31i-B Cycle Time Estimate Function for iHMI

### Notice

Certain functions may require additional hardware, different CPU type or additional memory capacity or may cause compatibility issue with other functions. In case of doubt, contact your FANUC sales representative for additional information and support.

The information given in the FANUC manuals or original manufacturer documentation shall prevail. Technical data is subject to change without prior notice. No part of this document may be reproduced in any form. All rights reserved. © FANUC 2017

# 492

## Editing Operation

# Cycle Time Estimate Library Function

## Features

Cycle Time Estimate is a function that can quickly estimate the execution cycle time of an NC program. It delivers estimations for cutting and rapid traverse times, time spent on the execution of auxiliary codes (e. g. M codes), as well as cutting and rapid traverse travel distances.

The accuracy of the estimation is higher than estimations made with 3rd party software. All estimations are calculated in consideration of the real machine's acceleration and deceleration. It is possible to estimate the machining time of complex programs, for example programs for 5-axis machining.

It is possible to create custom applications that incorporate the Cycle Time Estimate function, by using the Library contained in the "Disk for Cycle Time Estimate function". This option has to be effective in the CNC in order to use that library.

## Benefits

- Decrease processing time by optimizing programs
- Improve the utilization of machines by enhanced and reliable machine schedule planning

## Ordering Information

Specification	Description
A02B-0323-R900	30i-B Cycle Time Estimate Library Function
A02B-0326-R900	31i-B5 Cycle Time Estimate Library Function
A02B-0327-R900	31i-B Cycle Time Estimate Library Function

### Notice

Certain functions may require additional hardware, different CPU type or additional memory capacity or may cause compatibility issue with other functions. In case of doubt, contact your FANUC sales representative for additional information and support.

The information given in the FANUC manuals or original manufacturer documentation shall prevail. Technical data is subject to change without prior notice. No part of this document may be reproduced in any form. All rights reserved. © FANUC 2017

# 493

## Functions

## Setting and Display

---

This section of the catalogue contains the functions related to Display Functions which the CNC to display more than just the basic machine information.

Some of the functions detailed in the catalogue:

- Languages
- Machine operation menus
- Protection of data
- Graphic functions
- Etc.

### Notice

Certain functions may require additional hardware, different CPU type or additional memory capacity or may cause compatibility issue with other functions. In case of doubt, contact your FANUC sales representative for additional information and support.

The information given in the FANUC manuals or original manufacturer documentation shall prevail. Technical data is subject to change without prior notice. No part of this document may be reproduced in any form. All rights reserved. © FANUC 2017

# 494

## Setting and Display

# Run Hour and Parts Count Display

## Features

With the Run Hour and Parts Count Display function, various run times, the total number of machined parts, number of parts required, and number of machined parts can be displayed.

This function is a basic function in FANUC Series 0i-F.

## Benefits

- Easy shop floor data management

## Ordering Information

Specification	Description
A02B-0323-J971	30i-B Run Hour & Parts Count Display
A02B-0326-J971	31i-B5 Run Hour & Parts Count Display
A02B-0327-J971	31i-B Run Hour & Parts Count Display
A02B-0328-J971	32i-B Run Hour & Parts Count Display



### Notice

Certain functions may require additional hardware, different CPU type or additional memory capacity or may cause compatibility issue with other functions. In case of doubt, contact your FANUC sales representative for additional information and support.

The information given in the FANUC manuals or original manufacturer documentation shall prevail. Technical data is subject to change without prior notice. No part of this document may be reproduced in any form. All rights reserved. © FANUC 2017

# 495

## Setting and Display

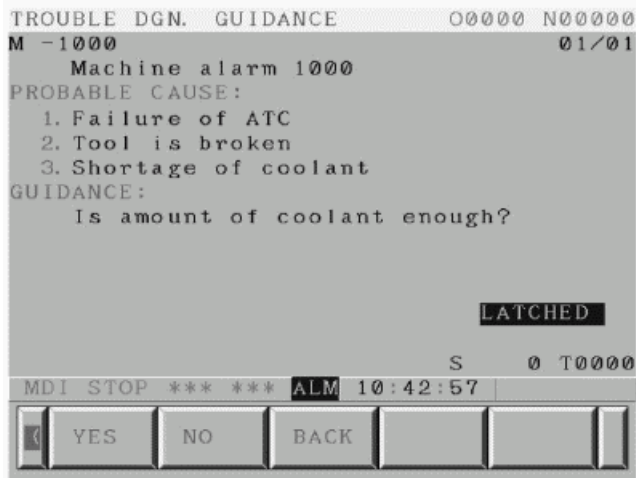

### Notice

Certain functions may require additional hardware, different CPU type or additional memory capacity or may cause compatibility issue with other functions. In case of doubt, contact your FANUC sales representative for additional information and support.

The information given in the FANUC manuals or original manufacturer documentation shall prevail. Technical data is subject to change without prior notice. No part of this document may be reproduced in any form. All rights reserved. © FANUC 2017

# Machine Alarm Diagnosis

## Features

Machine alarms (External alarm messages and Macro alarms) can be diagnosed on the a specific trouble diagnosis guidance screen in addition to the CNC alarms.

The following alarms can be diagnosed:

- External alarm message (Alarm No.1000-1999)
- Macro alarm (#3000) (Alarm No.3000-3200)

Guidance tables for diagnosis of machine alarms are made with Microsoft Excel sheet which is provided by FANUC.

Alarm No., Classified code, Alarm message, Probable cause and etc. are registered into a guidance table (1).

[Guidance Table (1)]									
No.	Alarm No.	Classified code		Alarm message	Probable cause			Message ID	(Reserved)
		Code 1	Code 2		Line 1	Line 2	Line 3		
1									
2									
3									

"Guidance message" is registered into a guidance table (2).

"Guidance message" is a question and an instruction to an operator.

[Guidance Table (2)]					
No.	Message ID	Guidance message	Next message ID		Comment
			YES	NO	
1					
2					
3					

## Benefits

- Possibility to create a performant and assisted alarm diagnostic system for the CNC
- Reduction of the time required to diagnose the problem
- Improves machining productivity



## Ordering Information

Specification	Description
A02B-0323-S813	30i-B Machine Alarm Diagnosis
A02B-0326-S813	31i-B5 Machine Alarm Diagnosis
A02B-0327-S813	31i-B Machine Alarm Diagnosis
A02B-0328-S813	32i-B Machine Alarm Diagnosis
A02B-0333-S813	35i-B Machine Alarm Diagnosis
A02B-0334-S813	PM i-A Machine Alarm Diagnosis
A02B-0339-S813	0i-TF Machine Alarm Diagnoses
A02B-0340-S813	0i-MF Machine Alarm Diagnoses

### Notice

Certain functions may require additional hardware, different CPU type or additional memory capacity or may cause compatibility issue with other functions. In case of doubt, contact your FANUC sales representative for additional information and support.

The information given in the FANUC manuals or original manufacturer documentation shall prevail. Technical data is subject to change without prior notice. No part of this document may be reproduced in any form. All rights reserved. © FANUC 2017

# 497

## Setting and Display

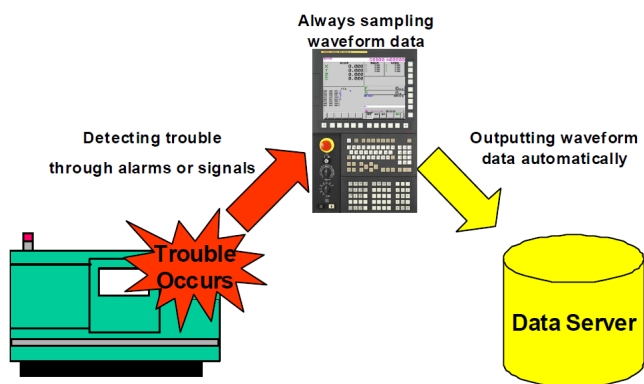

### Notice

Certain functions may require additional hardware, different CPU type or additional memory capacity or may cause compatibility issue with other functions. In case of doubt, contact your FANUC sales representative for additional information and support.

The information given in the FANUC manuals or original manufacturer documentation shall prevail. Technical data is subject to change without prior notice. No part of this document may be reproduced in any form. All rights reserved. © FANUC 2017

# Servo/Spindle Waveform Data Output Function

## Features

If a failure occurs on a machine, with this function servo and spindle waveform data is automatically output to the data server. Waveform data before and after the failure event is saved, making it easier to detect the cause of the failure. This function also facilitates the application of remote service software.

## Note

The data server function is required to use this function.

## Benefits

- Reduces downtime and service costs

## Ordering Information

Specification	Description
A02B-0323-R588	30i-B Servo / Spindle Waveform Data Output Function
A02B-0326-R588	31i-B5 Servo / Spindle Waveform Data Output Function
A02B-0327-R588	31i-B Servo / Spindle Waveform Data Output Function
A02B-0328-R588	32i-B Servo / Spindle Waveform Data Output Function
A02B-0339-R588	0i-TF Servo / Spindle Waveform Data Output Function
A02B-0340-R588	0i-MF Servo / Spindle Waveform Data Output Function

# 498

## Setting and Display

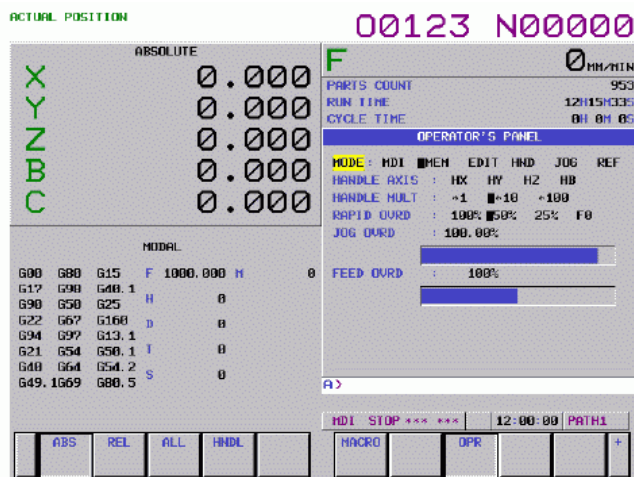

# Software Operator's Panel

## Features

The functions of switches on the machine operator's panel are made available by using the MDI panel. This means that functions such as a mode selection and selection of jog feedrate override can be made by operating the MDI panel, so corresponding switches on the machine operator's panel need not be used.

This function is enabled only when the software operator's panel screen is displayed. The user can make selection operations by moving the cursor by using the cursor keys while checking the screen.

The following functions can be performed:

- A : Mode selection
- B : Selection of jog feed axis, manual rapid traverse
- C : Selection of manual pulse generator feed axis, selection of manual pulse magnification
- D : Jog federate, federate override, rapid traverse override
- E : Optional block skip, single block, machine lock, dry run
- F : Protect key
- G : Feed hold
- H : General purpose switch

A parameter that enables and disables MDI operations is provided for each of operation groups A to G indicated above.

This function is a basic function in FANUC Series 0i-F.

## Benefits

- Simplifies the operation of the machine
- Improves machining productivity

## Ordering Information

Specification	Description
A02B-0323-J960	30i-B Software Operator's Panel
A02B-0326-J960	31i-B5 Software Operator's Panel
A02B-0327-J960	31i-B Software Operator's Panel
A02B-0328-J960	32i-B Software Operator's Panel

### Notice

Certain functions may require additional hardware, different CPU type or additional memory capacity or may cause compatibility issue with other functions. In case of doubt, contact your FANUC sales representative for additional information and support.

The information given in the FANUC manuals or original manufacturer documentation shall prevail. Technical data is subject to change without prior notice. No part of this document may be reproduced in any form. All rights reserved. © FANUC 2017

# 499

## Setting and Display

### OPERATOR'S PANEL

<b>OVR信号1</b>	: ■ OFF	ON
	: ■ OFF	ON
	: ■ OFF	ON
	: ■ OFF	ON
	: ■ OFF	ON
	: ■ OFF	ON
	: ■ OFF	ON
	: ■ OFF	ON

# Software Operator's Panel General Purpose Switch

## Features

This function allows the user to assign arbitrary signals to general purpose switches 1 to 16 on the software operator's panel.

This function is a basic function in FANUC Series 0i-F.

## Benefits

- Simplifies the operation of the machine
- Improves machining productivity

## Ordering Information

Specification	Description
A02B-0323-J961	30i-B Software Operator's Panel General Purpose Switch
A02B-0326-J961	31i-B5 Software Operator's Panel General Purpose Switch
A02B-0327-J961	31i-B Software Operator's Panel General Purpose Switch
A02B-0328-J961	32i-B Software Operator's Panel General Purpose Switch

### Notice

Certain functions may require additional hardware, different CPU type or additional memory capacity or may cause compatibility issue with other functions. In case of doubt, contact your FANUC sales representative for additional information and support.

The information given in the FANUC manuals or original manufacturer documentation shall prevail. Technical data is subject to change without prior notice. No part of this document may be reproduced in any form. All rights reserved. © FANUC 2017

# 500

## Setting and Display

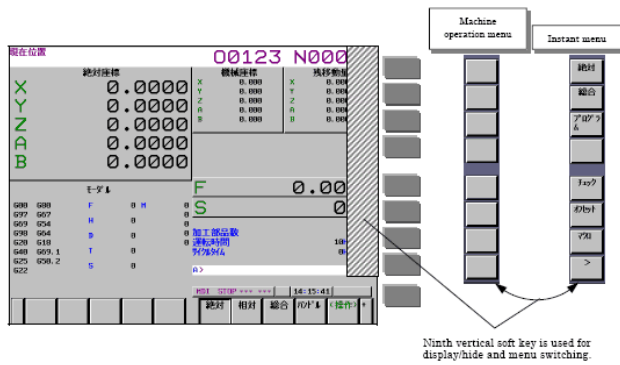

# Machine Operation Menu

## Features

### Machine Operation Menu Function

The soft keys displayed on the standard CNC screen can be used as menu keys for the machine operation.

The soft keys can be customized easily by the machine tool builder. A menu can have a hierarchy, and the indication of each soft key can be specified.

Customization data is created as a machine operation menu definition file and is stored in the CNC.

### Machine Operation Menu Tool

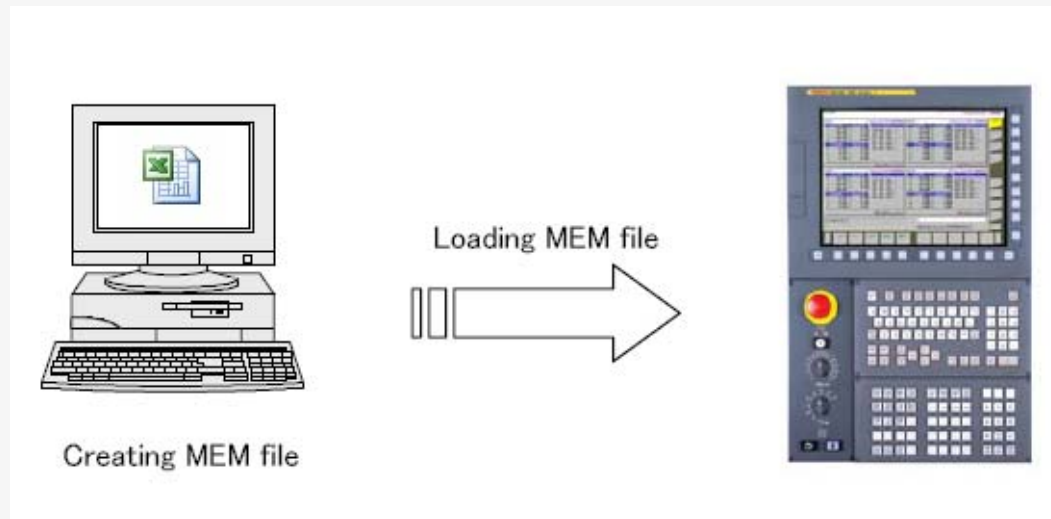

When using the "Machine Operation Menu" making tool it is possible to define the machine operation menu and output the defined contents as MEM file.

## Benefits

- Simplifies the operation of the machine
- Improves machining productivity

### Notice

Certain functions may require additional hardware, different CPU type or additional memory capacity or may cause compatibility issue with other functions. In case of doubt, contact your FANUC sales representative for additional information and support.

The information given in the FANUC manuals or original manufacturer documentation shall prevail. Technical data is subject to change without prior notice. No part of this document may be reproduced in any form. All rights reserved. © FANUC 2017

# 501

## Ordering Information

Specification	Description
A02B-0323-S844	30i-B Machine Operation Menu
A02B-0326-S844	31i-B5 Machine Operation Menu
A02B-0327-S844	31i-B Machine Operation Menu
A02B-0328-S844	32i-B Machine Operation Menu
A02B-0339-S844	0i-TF Machine Operation Menu
A02B-0340-S844	0i-MF Machine Operation Menu

### Notice

Certain functions may require additional hardware, different CPU type or additional memory capacity or may cause compatibility issue with other functions. In case of doubt, contact your FANUC sales representative for additional information and support.

The information given in the FANUC manuals or original manufacturer documentation shall prevail. Technical data is subject to change without prior notice. No part of this document may be reproduced in any form. All rights reserved. © FANUC 2017

# 502

## Setting and Display

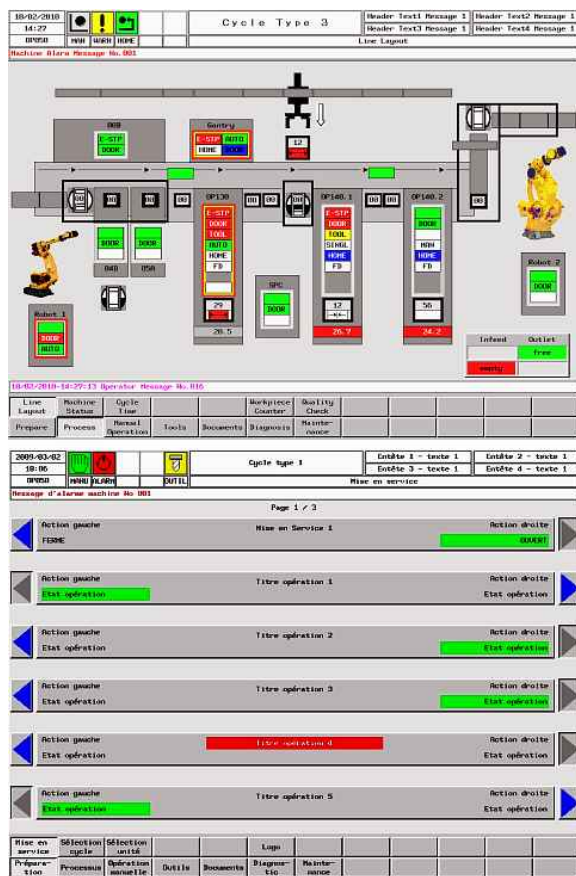

### Notice

Certain functions may require additional hardware, different CPU type or additional memory capacity or may cause compatibility issue with other functions. In case of doubt, contact your FANUC sales representative for additional information and support.

The information given in the FANUC manuals or original manufacturer documentation shall prevail. Technical data is subject to change without prior notice. No part of this document may be reproduced in any form. All rights reserved. © FANUC 2017

# FANUC Auto HMI-NC

## Features

FANUC Auto HMI-NC is an application composed of a set of HMI templates, objects, tables and scripts to create standardized user interfaces in automotive applications or machining applications producing large batches of products.

Typical screens are provided such as workpiece counters; tool life overview; manual operations etc. are available. The screens are multilingual and can be easily customized and supplemented by the machine manufacturer.

FANUC Auto HMI-NC is based on FANUC PICTURE. The main target of this application is to visualize the detailed status of a single machine, but also to provide on each machine a view and general information about the production line. It supports the 15 inch Display Station for Automotive as well as the 15" and 10" Touch Panel LCD displays.

The FANUC Auto HMI-NC application runs directly in the CNC, and is designed for 'passive' LCD displays (10.4 inch and 15 inch). The whole HMI system is cost effective and extremely reliable.

FANUC Auto HMI-NC has been developed to meet the requirements of standardization of operation of automotive machining plants and high volume production lines. This application contains a basic set of standardized HMI screens as well as libraries of objects based on "FANUC PICTURE".

Typical screens available:

- Power-On Conditions
- Line Layout
- Shift Counter
- Tool Lifetime
- Maintenance Menu
- Cycle Type Selection
- Machine Status
- Manual Operations
- Diagnosis Menu

'FANUC Auto HMI-NC' supports multi-language, with immediate switching between the languages. It can also be switched automatically with the language selected in the CNC. English is always available for maintenance reasons, one language for the end-user and one language for the machine builder / integrator. Language tables are easy to update and provide to external translation companies through the export-import functions.

The Machine Builder or Integrator can develop its own screens to match his application requirements, based on templates and library of objects provided. In this case, FANUC PICTURE package is required. Animated objects, alarms or any data used in the FANUC Auto HMI-NC are mapped in PMC data tables for easy integration with the CNC.

## Benefits

- No PC hardware used, no Hard-Disk, No Windows® operating system, absolute virus immunity
- Screens and HMI located in the CNC - No operating system to maintain in the display
- Customizable through FANUC PICTURE
- Plug and Play display - easy to maintain
- No particular boot and shutdown procedure of the CNC, HMI and display

## Ordering Information

Specification	Description
A02B-0323-R572	30i-B FANUC Auto HMI-NC
A02B-0323-R653	30i-B FANUC Auto HMI-NC, Screen Enhancement 1
A02B-0326-R572	31i-B5 FANUC Auto HMI-NC
A02B-0326-R653	31i-B5 FANUC Auto HMI-NC, Screen Enhancement 1
A02B-0327-R572	31i-B FANUC Auto HMI-NC
A02B-0327-R653	31i-B FANUC Auto HMI-NC, Screen Enhancement 1
A02B-0328-R572	32i-B FANUC Auto HMI-NC
A02B-0328-R653	32i-B FANUC Auto HMI-NC, Screen Enhancement 1
A02B-0333-R572	35i-B FANUC Auto HMI-NC
A02B-0333-R653	35i-B FANUC Auto HMI-NC, Screen Enhancement 1
A02B-0334-R572	PM i-A FANUC Auto HMI-NC
A02B-0334-R653	PM i-A FANUC Auto HMI-NC, Screen Enhancement 1
A02B-0339-R572	0i-TF FANUC Auto HMI-NC
A02B-0339-R653	0i-TF FANUC Auto HMI-NC Screen Enhancement 1
A02B-0340-R572	0i-MF FANUC Auto HMI-NC
A02B-0340-R653	0i-MF FANUC Auto HMI-NC Screen Enhancement 1

### Notice

Certain functions may require additional hardware, different CPU type or additional memory capacity or may cause compatibility issue with other functions. In case of doubt, contact your FANUC sales representative for additional information and support.

The information given in the FANUC manuals or original manufacturer documentation shall prevail. Technical data is subject to change without prior notice. No part of this document may be reproduced in any form. All rights reserved. © FANUC 2017



# 504

## Setting and Display



### Notice

Certain functions may require additional hardware, different CPU type or additional memory capacity or may cause compatibility issue with other functions. In case of doubt, contact your FANUC sales representative for additional information and support.

The information given in the FANUC manuals or original manufacturer documentation shall prevail. Technical data is subject to change without prior notice. No part of this document may be reproduced in any form. All rights reserved. © FANUC 2017

## Multi-Language Display

### Features

The Multi Language Display is the language that is used for user guidance on the CNC.

The user can switch the operator language without restart of the control on the 30i, 31i and 32i controls whereas a restart is necessary on 0i controls.

### Selection of Five Optional Languages

CNC system provides many optional languages for the display screens. This function allows the selection of up to five languages according to the parameter among the optional language stored in CNC system. These selected languages and English can be displayed.

Refer to the ordering information table for the available languages.

### Benefits

- Simplifies the operation of the machine in languages other than English
- Improves machining productivity

### Ordering Information

Specification	Description
A02B-0323-J650	30i-B Danish Language Display
A02B-0323-J678	30i-B Portuguese Language Display
A02B-0323-J962	30i-B Dutch Language Display
A02B-0323-J965	30i-B Japanese Language Display
A02B-0323-J967	30i-B Chinese Language Display, Traditional Characters
A02B-0323-J968	30i-B Italian Language Display
A02B-0323-J969	30i-B Korean Language Display
A02B-0323-J970	30i-B Spanish Language Display
A02B-0323-R587	30i-B Turkish Language Display
A02B-0323-R686	30i-B Bulgarian Language Display
A02B-0323-R693	30i-B Slovakian Language Display
A02B-0323-R694	30i-B Romanian Language Display
A02B-0323-R726	30i-B Finnish Language Display
A02B-0323-S689	30i-B Czech Language Display

Specification	Description
A02B-0323-S690	30i-B Hungarian Language Display
A02B-0323-S691	30i-B Swedish Language Display
A02B-0323-S739	30i-B Polish Language Display
A02B-0323-S829	30i-B Chinese Language Display, Simplified Chinese Characters
A02B-0323-S839	30i-B German Language Display
A02B-0323-S841	30i-B French Language Display
A02B-0323-S849	30i-B Russian Language Display
A02B-0326-J650	31i-B5 Danish Language Display
A02B-0326-J678	31i-B5 Portuguese Language Display
A02B-0326-J962	31i-B5 Dutch Language Display
A02B-0326-J965	31i-B5 Japanese Language Display
A02B-0326-J967	31i-B5 Chinese Language Display, Traditional Characters
A02B-0326-J968	31i-B5 Italian Language Display
A02B-0326-J969	31i-B5 Korean Language Display
A02B-0326-J970	31i-B5 Spanish Language Display
A02B-0326-R587	31i-B5 Turkish Language Display
A02B-0326-R686	31i-B5 Bulgarian Language Display
A02B-0326-R693	31i-B5 Slovakian Language Display
A02B-0326-R694	31i-B5 Romanian Language Display
A02B-0326-R726	31i-B5 Finnish Language Display
A02B-0326-S689	31i-B5 Czech Language Display
A02B-0326-S690	31i-B5 Hungarian Language Display
A02B-0326-S691	31i-B5 Swedish Language Display
A02B-0326-S739	31i-B5 Polish Language Display
A02B-0326-S829	31i-B5 Chinese Language Display, Simplified Chinese Characters
A02B-0326-S839	31i-B5 German Language Display
A02B-0326-S841	31i-B5 French Language Display
A02B-0326-S849	31i-B5 Russian Language Display
A02B-0327-J650	31i-B Danish Language Display
A02B-0327-J678	31i-B Portuguese Language Display
A02B-0327-J962	31i-B Dutch Language Display
A02B-0327-J965	31i-B Japanese Language Display
A02B-0327-J967	31i-B Chinese Language Display, Traditional Characters
A02B-0327-J968	31i-B Italian Language Display
A02B-0327-J969	31i-B Korean Language Display
A02B-0327-J970	31i-B Spanish Language Display
A02B-0327-R587	31i-B Turkish Language Display
A02B-0327-R686	31i-B Bulgarian Language Display
A02B-0327-R693	31i-B Slovakian Language Display
A02B-0327-R694	31i-B Romanian Language Display

## Notice

Certain functions may require additional hardware, different CPU type or additional memory capacity or may cause compatibility issue with other functions. In case of doubt, contact your FANUC sales representative for additional information and support.

The information given in the FANUC manuals or original manufacturer documentation shall prevail. Technical data is subject to change without prior notice. No part of this document may be reproduced in any form. All rights reserved. © FANUC 2017

Specification	Description
A02B-0327-R726	31i-B Finnish Language Display
A02B-0327-S689	31i-B Czech Language Display
A02B-0327-S690	31i-B Hungarian Language Display
A02B-0327-S691	31i-B Swedish Language Display
A02B-0327-S739	31i-B Polish Language Display
A02B-0327-S829	31i-B Chinese Language Display, Simplified Chinese Characters
A02B-0327-S839	31i-B German Language Display
A02B-0327-S841	31i-B French Language Display
A02B-0327-S849	31i-B Russian Language Display
A02B-0328-J650	32i-B Danish Language Display
A02B-0328-J678	32i-B Portuguese Language Display
A02B-0328-J962	32i-B Dutch Language Display
A02B-0328-J965	32i-B Japanese Language Display
A02B-0328-J967	32i-B Chinese Language Display, Traditional Characters
A02B-0328-J968	32i-B Italian Language Display
A02B-0328-J969	32i-B Korean Language Display
A02B-0328-J970	32i-B Spanish Language Display
A02B-0328-R587	32i-B Turkish Language Display
A02B-0328-R686	32i-B Bulgarian Language Display
A02B-0328-R693	32i-B Slovakian Language Display
A02B-0328-R694	32i-B Romanian Language Display
A02B-0328-R726	32i-B Finnish Language Display
A02B-0328-S689	32i-B Czech Language Display
A02B-0328-S690	32i-B Hungarian Language Display
A02B-0328-S691	32i-B Swedish Language Display
A02B-0328-S739	32i-B Polish Language Display
A02B-0328-S829	32i-B Chinese Language Display, Simplified Chinese Characters
A02B-0328-S839	32i-B German Language Display
A02B-0328-S841	32i-B French Language Display
A02B-0328-S849	32i-B Russian Language Display
A02B-0333-J650	35i-B Danish Language Display
A02B-0333-J678	35i-B Portuguese Language Display
A02B-0333-J962	35i-B Dutch Language Display
A02B-0333-J967	35i-B Chinese Language Display, Traditional Characters
A02B-0333-J968	35i-B Italian Language Display
A02B-0333-J969	35i-B Korean Language Display
A02B-0333-J970	35i-B Spanish Language Display
A02B-0333-R587	35i-B Turkish Language Display
A02B-0333-S689	35i-B Czech Language Display
A02B-0333-S690	35i-B Hungarian Language Display

**Notice**

Certain functions may require additional hardware, different CPU type or additional memory capacity or may cause compatibility issue with other functions. In case of doubt, contact your FANUC sales representative for additional information and support.

The information given in the FANUC manuals or original manufacturer documentation shall prevail. Technical data is subject to change without prior notice. No part of this document may be reproduced in any form. All rights reserved. © FANUC 2017

Specification	Description
A02B-0333-S691	35i-B Swedish Language Display
A02B-0333-S739	35i-B Polish Language Display
A02B-0333-S829	35i-B Chinese Language Display, Simplified Chinese Characters
A02B-0333-S839	35i-B German Language Display
A02B-0333-S841	35i-B French Language Display
A02B-0333-S849	35i-B Russian Language Display
A02B-0334-J650	PM i-A Danish Language Display
A02B-0334-J678	PM i-A Portuguese Language Display
A02B-0334-J962	PM i-A Dutch Language Display
A02B-0334-J967	PM i-A Chinese Language Display
A02B-0334-J968	PM i-A Italian Language Display
A02B-0334-J969	PM i-A Korean Language Display
A02B-0334-J970	PM i-A Spanish Language Display
A02B-0334-R587	PM i-A Turkish Language Display
A02B-0334-S689	PM i-A Czech Language Display
A02B-0334-S690	PM i-A Hungarian Language Display
A02B-0334-S691	PM i-A Swedish Language Display
A02B-0334-S739	PM i-A Polish Language Display
A02B-0334-S829	PM i-A Chinese Language Display, Simplified Chinese Characters
A02B-0334-S839	PM i-A German Language Display
A02B-0334-S841	PM i-A French Language Display
A02B-0334-S849	PM i-A Russian Language Display
A02B-0339-J650	0i-TF Multi-Language Display Danish
A02B-0339-J962	0i-TF Multi-Language Display Dutch
A02B-0339-J965	0i-TF Multi-Language Display Japanese
A02B-0339-J968	0i-TF Multi-Language Display Italian
A02B-0339-J969	0i-TF Multi-Language Display Korean
A02B-0339-R686	0i-TF Multi-Language Display Bulgarian
A02B-0339-R693	0i-TF Multi-Language Display Slovak
A02B-0339-R694	0i-TF Multi-Language Display Romanian
A02B-0339-R726	0i-TF Multi-Language Display Finnish
A02B-0339-S689	0i-TF Multi-Language Display Czech
A02B-0339-S690	0i-TF Multi-Language Display Hungarian
A02B-0339-S691	0i-TF Multi-Language Display Swedish
A02B-0339-S739	0i-TF Multi-Language Display Polish
A02B-0339-S839	0i-TF Multi-Language Display German
A02B-0339-S841	0i-TF Multi-Language Display French
A02B-0340-J650	0i-MF Multi-Language Display Danish
A02B-0340-J962	0i-MF Multi-Language Display Dutch
A02B-0340-J965	0i-MF Multi-Language Display Japanese

**Notice**

Certain functions may require additional hardware, different CPU type or additional memory capacity or may cause compatibility issue with other functions. In case of doubt, contact your FANUC sales representative for additional information and support.

The information given in the FANUC manuals or original manufacturer documentation shall prevail. Technical data is subject to change without prior notice. No part of this document may be reproduced in any form. All rights reserved. © FANUC 2017

# 508

Specification	Description
A02B-0340-J968	0i-MF Multi-Language Display Italian
A02B-0340-J969	0i-MF Multi-Language Display Korean
A02B-0340-R686	0i-MF Multi-Language Display Bulgarian
A02B-0340-R693	0i-MF Multi-Language Display Slovak
A02B-0340-R694	0i-MF Multi-Language Display Romanian
A02B-0340-R726	0i-MF Multi-Language Display Finnish
A02B-0340-S689	0i-MF Multi-Language Display Czech
A02B-0340-S690	0i-MF Multi-Language Display Hungarian
A02B-0340-S691	0i-MF Multi-Language Display Swedish
A02B-0340-S739	0i-MF Multi-Language Display Polish
A02B-0340-S839	0i-MF Multi-Language Display German
A02B-0340-S841	0i-MF Multi-Language Display French

## Notice

Certain functions may require additional hardware, different CPU type or additional memory capacity or may cause compatibility issue with other functions. In case of doubt, contact your FANUC sales representative for additional information and support.

The information given in the FANUC manuals or original manufacturer documentation shall prevail. Technical data is subject to change without prior notice. No part of this document may be reproduced in any form. All rights reserved. © FANUC 2017

# 509

## Setting and Display

# Selection of Five Optional Languages

## Features

This function allows to activate 5 different languages at once in the CNC. The 5 languages then are activated and the user can switch between the languages on the fly.

## Benefits

- Increase the flexibility of the CNC usage in multi-language environment

## Ordering Information

Specification	Description
A02B-0323-R521	30i-B Selection of Five Optional Languages - Select Option Assemblies According Desired 5 Languages - Do Not Specify Any Single Language Option
A02B-0326-R521	31i-B5 Selection of Five Optional Languages - Select Option Assemblies According Desired 5 Languages - Do Not Specify Any Single Language Option
A02B-0327-R521	31i-B Selection of Five Optional Languages - Select Option Assemblies According Desired 5 Languages - Do Not Specify Any Single Language Option
A02B-0328-R521	32i-B Selection of Five Optional Languages - Select Option Assemblies According Desired 5 Languages - Do Not Specify Any Single Language Option
A02B-0333-R521	35i-B Selection of Five Optional Languages - Select Option Assemblies According Desired 5 Languages - Do Not Specify Any Single Language Option
A02B-0334-R521	PM i-A Selection of Five Optional Languages

### Notice

Certain functions may require additional hardware, different CPU type or additional memory capacity or may cause compatibility issue with other functions. In case of doubt, contact your FANUC sales representative for additional information and support.

The information given in the FANUC manuals or original manufacturer documentation shall prevail. Technical data is subject to change without prior notice. No part of this document may be reproduced in any form. All rights reserved. © FANUC 2017

# 510

## Setting and Display

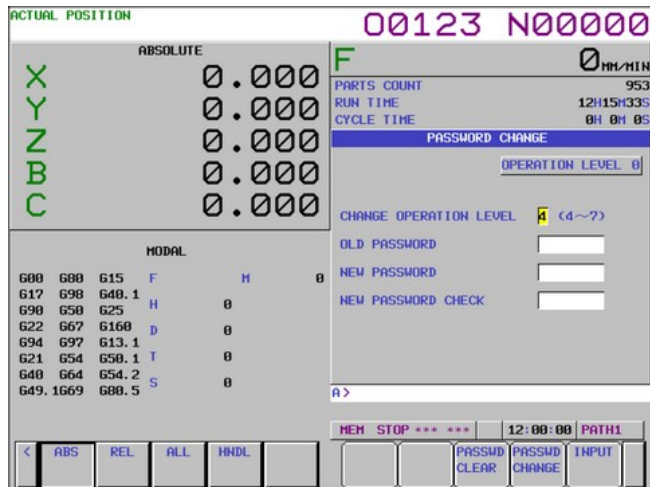

# Protection of Data at Eight Levels

## Features

The Protection of Data at Eight Levels function provides the ability to define multiple levels of access for the operators of the machine. Eight operation levels can be set for the CNC and PMC operations, and eight protection levels can be set for various types of CNC and PMC data.

When the CNC and PMC data is modified or output externally, the operation level and protect level are compared to determine whether to allow the modification or external output.

## Benefits

- Improvement of the safety of operation of the machine
- Improves machining productivity

## Ordering Information

Specification	Description
A02B-0323-S828	30i-B Protection of Data at Eight Levels
A02B-0326-S828	31i-B5 Protection of Data at Eight Levels
A02B-0327-S828	31i-B Protection of Data at Eight Levels
A02B-0328-S828	32i-B Protection of Data at Eight Levels
A02B-0333-S828	35i-B Protection of Data at Eight Levels
A02B-0334-S828	PM i-A Protection of Data at Eight Levels
A02B-0339-S828	0i-TF Protection of Data at Eight Levels
A02B-0340-S828	0i-MF Protection of Data at Eight Levels

### Notice

Certain functions may require additional hardware, different CPU type or additional memory capacity or may cause compatibility issue with other functions. In case of doubt, contact your FANUC sales representative for additional information and support.

The information given in the FANUC manuals or original manufacturer documentation shall prevail. Technical data is subject to change without prior notice. No part of this document may be reproduced in any form. All rights reserved. © FANUC 2017





# 512

## Setting and Display

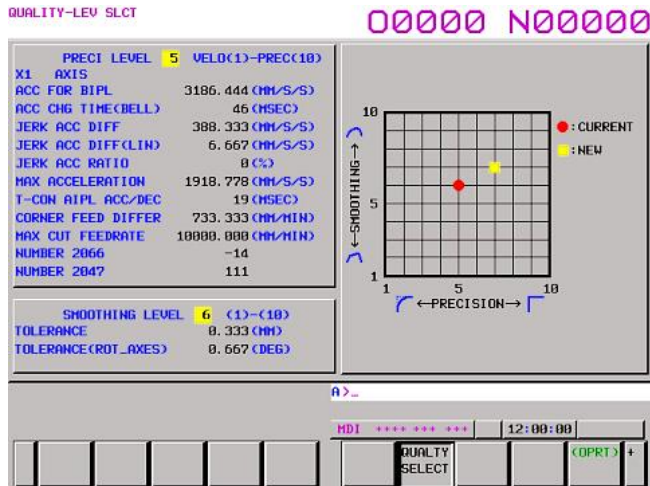

### Notice

Certain functions may require additional hardware, different CPU type or additional memory capacity or may cause compatibility issue with other functions. In case of doubt, contact your FANUC sales representative for additional information and support.

The information given in the FANUC manuals or original manufacturer documentation shall prevail. Technical data is subject to change without prior notice. No part of this document may be reproduced in any form. All rights reserved. © FANUC 2017

# Machining Quality Level Adjustment

## Features

Smoothing and precision level of the Nano smoothing function can be adjusted from an adjustment screen to set machining quality level.

The following options are necessary:

- AI contour control 1 or AI contour control 2
- Nano smoothing
- The machining condition selection function

## Benefits

- Simplifies the operation of the machine
- Improves machining productivity

## Ordering Information

Specification	Description
A02B-0323-R593	30i-B Machining Quality Level Adjustment
A02B-0326-R593	31i-B5 Machining Quality Level Adjustment
A02B-0327-R593	31i-B Machining Quality Level Adjustment
A02B-0328-R593	32i-B Machining Quality Level Adjustment
A02B-0340-R593	0i-MF Machining Quality Adjustment Function

# 513

## Setting and Display

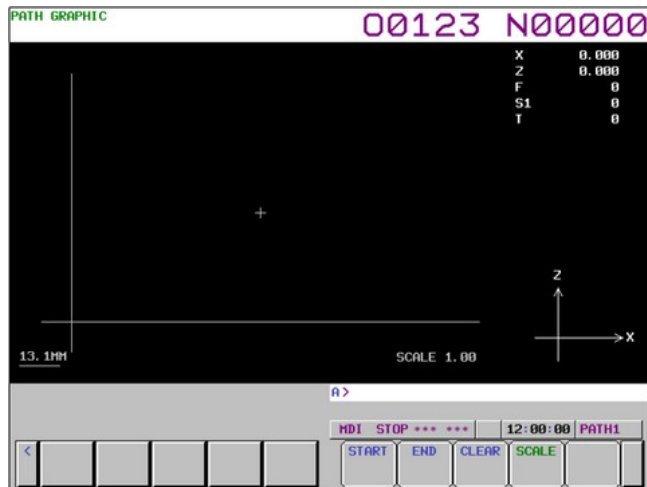

## Graphic Function

### Features

Graphic Display option allows the tool path of a program to be drawn during machining.

This function is a basic function in FANUC Series 0i-F.

### Benefits

- Easy to prove out tool paths
- Minimized crashes and scrap parts
- Reduced Set up/prove out time
- Increased operator confidence for running part program
- Easy to verify all 3 planes XY, YZ, ZX including isometric views
- Zooming for easy verification of dense cuts

### Ordering Information

Specification	Description
A02B-0323-J972	30i-B Graphic Display
A02B-0326-J972	31i-B5 Graphic Display
A02B-0327-J972	31i-B Graphic Display
A02B-0328-J972	32i-B Graphic Display
A02B-0331-J972	30i-PB Graphic Display
A02B-0332-J972	31i-PB Graphic Display

### Notice

Certain functions may require additional hardware, different CPU type or additional memory capacity or may cause compatibility issue with other functions. In case of doubt, contact your FANUC sales representative for additional information and support.

The information given in the FANUC manuals or original manufacturer documentation shall prevail. Technical data is subject to change without prior notice. No part of this document may be reproduced in any form. All rights reserved. © FANUC 2017

# 514

## Setting and Display

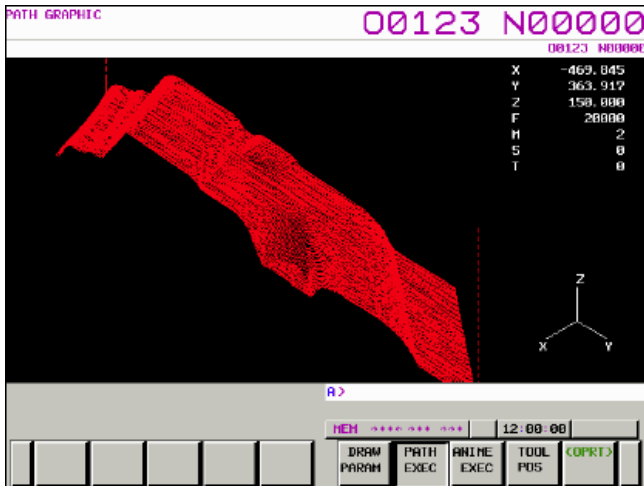

# Dynamic Graphic Display Function

## Features

Created programs can be checked visually by displaying them using graphic data. Graphic data can be displayed in the following two drawing modes:

- Tool path drawing mode: Tool paths are drawn with lines.
- Animation drawing mode: The profile of a workpiece that changes as the tool moves can be simulated and drawn three-dimensionally.

## Benefits

- Much faster drawing capabilities compared to Graphic Display function
- Easy to prove out tool paths
- Minimized crashes and scrap parts
- Reduced Set up/prove out time
- Increased operator confidence for running part program
- Easy to verify all 3 planes XY, YZ, ZX including isometric views
- Zooming for easy verification of dense cuts

## Ordering Information

Specification	Description
A02B-0323-J760	30i-B Dynamic Graphic Display Function
A02B-0326-J760	31i-B5 Dynamic Graphic Display Function
A02B-0327-J760	31i-B Dynamic Graphic Display Function
A02B-0328-J760	32i-B Dynamic Graphic Display Function
A02B-0339-J760	0i-TF Dynamic Graphic Display
A02B-0340-J760	0i-MF Dynamic Graphic Display

### Notice

Certain functions may require additional hardware, different CPU type or additional memory capacity or may cause compatibility issue with other functions. In case of doubt, contact your FANUC sales representative for additional information and support.

The information given in the FANUC manuals or original manufacturer documentation shall prevail. Technical data is subject to change without prior notice. No part of this document may be reproduced in any form. All rights reserved. © FANUC 2017

# 515

## Setting and Display

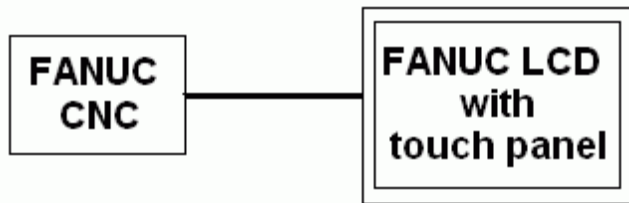

## Touch Panel Control

### Features

The Touch Panel Control function is required to support the Touch Panel display of the CNC. The physical Touch Panel display is also required.

A display unit with a touch panel enables the operator to perform control of the menus touching the screen.

### Benefits

- Simplifies the operation of the machine
- Improves machining productivity

### Ordering Information

Specification	Description
A02B-0323-J682	30i-B Touch Panel Control
A02B-0326-J682	31i-B5 Touch Panel Control
A02B-0327-J682	31i-B Touch Panel Control
A02B-0328-J682	32i-B Touch Panel Control
A02B-0339-J682	0i-TF Touch Panel Control
A02B-0340-J682	0i-MF Touch Panel Control

#### Notice

Certain functions may require additional hardware, different CPU type or additional memory capacity or may cause compatibility issue with other functions. In case of doubt, contact your FANUC sales representative for additional information and support.

The information given in the FANUC manuals or original manufacturer documentation shall prevail. Technical data is subject to change without prior notice. No part of this document may be reproduced in any form. All rights reserved. © FANUC 2017

# 516

## Setting and Display

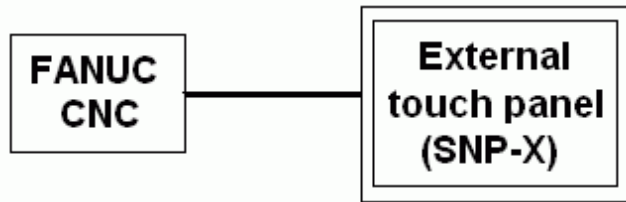

## External Touch Panel Interface

### Features

The External Touch Panel Interface allows an External Touch Panel using the SNP-X protocol to be connected with the CNC.

The External Touch Panel Interface has functions that can read / write in from / to the PMC such control signals as input signal(X), output signal(Y), internal relay(R), keep relay(K), data table(D), timer(T), counter(C) and the function is almost the same as operating panel of machine.

### Benefits

- Simplifies the connection of 3rd party screens using the SNP-X protocol of GE
- Improves machining productivity

### Ordering Information

Specification	Description
A02B-0323-J685	30i-B External Touch Panel Interface
A02B-0326-J685	31i-B5 External Touch Panel Interface
A02B-0327-J685	31i-B External Touch Panel Interface
A02B-0328-J685	32i-B External Touch Panel Interface
A02B-0333-J685	35i-B External Touch Panel Interface
A02B-0334-J685	PM i-A External Touch Panel Interface
A02B-0339-J685	0i-TF External Touch Panel interface
A02B-0340-J685	0i-MF External Touch Panel interface

#### Notice

Certain functions may require additional hardware, different CPU type or additional memory capacity or may cause compatibility issue with other functions. In case of doubt, contact your FANUC sales representative for additional information and support.

The information given in the FANUC manuals or original manufacturer documentation shall prevail. Technical data is subject to change without prior notice. No part of this document may be reproduced in any form. All rights reserved. © FANUC 2017

# 517

## Setting and Display

# Two Touch Panels Control for Stand-Alone Type CNC

---

## Features

An external touch panel can be used together with the Stand-Alone Type CNC display's touch panel.

## Benefits

- Operation improvement of large machines

## Ordering Information

Specification	Description
A02B-0323-R658	30i-B Two Touch Panel Control for Stand-Alone Type CNC
A02B-0326-R658	31i-B5 Two Touch Panel Control for Stand-Alone Type CNC
A02B-0327-R658	31i-B Two Touch Panel Control for Stand-Alone Type CNC
A02B-0328-R658	32i-B Two Touch Panel Control for Stand-Alone Type CNC
A02B-0333-R658	35i-B Two Touch Panel Control for Stand-Alone Type CNC
A02B-0334-R658	PM i-A Two Touch Panel Control for Stand-Alone Type CNC

### Notice

Certain functions may require additional hardware, different CPU type or additional memory capacity or may cause compatibility issue with other functions. In case of doubt, contact your FANUC sales representative for additional information and support.

The information given in the FANUC manuals or original manufacturer documentation shall prevail. Technical data is subject to change without prior notice. No part of this document may be reproduced in any form. All rights reserved. © FANUC 2017

# 518

## Setting and Display

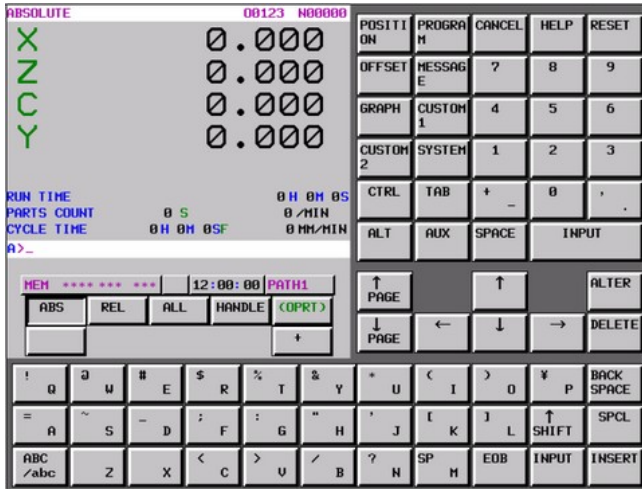

### Notice

Certain functions may require additional hardware, different CPU type or additional memory capacity or may cause compatibility issue with other functions. In case of doubt, contact your FANUC sales representative for additional information and support.

The information given in the FANUC manuals or original manufacturer documentation shall prevail. Technical data is subject to change without prior notice. No part of this document may be reproduced in any form. All rights reserved. © FANUC 2017

# Virtual MDI Key

## Features

The Virtual MDI Key function provides a replacement for the physical MDI unit; in this case, the MDI keys are displayed on the Touch Screen.

Since the MDI key hardware is not required any more, a more compact operator panel can be designed.

## Benefits

- Simplifies the design of compact operator panels

## Ordering Information

Specification	Description
A02B-0323-S883	30i-B Virtual MDI Key Function
A02B-0326-S883	31i-B5 Virtual MDI Key Function
A02B-0327-S883	31i-B Virtual MDI Key Function
A02B-0328-S883	32i-B Virtual MDI Key Function
A02B-0339-S883	0i-TF Virtual MDI Key
A02B-0340-S883	0i-MF Virtual MDI Key

# 519

## Setting and Display

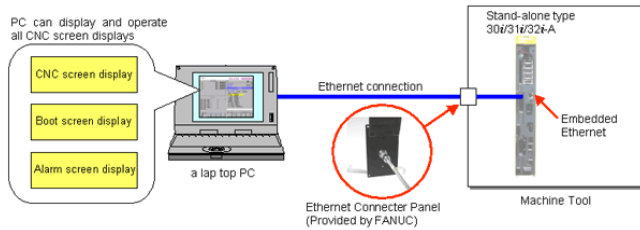

## Ethernet Display Function

### Features

The Ethernet Display Function provides CNC screen display on PC screen via Embedded Ethernet.

Its capability to show maintenance screen display, boot and alarm, in addition to CNC screen display for usual operation, enables linking to PC for maintenance, instead of the CNC display unit.

### Benefits

- Provide Ethernet connectivity and remote control function for the CNC
- Improves machining productivity

### Ordering Information

Specification	Description
A02B-0323-R950	30i-B Ethernet Display Function
A02B-0326-R950	31i-B5 Ethernet Display Function
A02B-0327-R950	31i-B Ethernet Display Function
A02B-0328-R950	32i-B Ethernet Display Function
A02B-0333-R950	35i-B Ethernet Display Function
A02B-0334-R950	PM i-A Ethernet Display Function
A02B-0339-R950	0i-TF Ethernet Display Function
A02B-0340-R950	0i-MF Ethernet Display Function

### Notice

Certain functions may require additional hardware, different CPU type or additional memory capacity or may cause compatibility issue with other functions. In case of doubt, contact your FANUC sales representative for additional information and support.

The information given in the FANUC manuals or original manufacturer documentation shall prevail. Technical data is subject to change without prior notice. No part of this document may be reproduced in any form. All rights reserved. © FANUC 2017



# 520

## Setting and Display

# Ethernet Display Sharing Function

## Features

The Ethernet Display Sharing function provides the possibility to allocate one display screen to several standalone CNC. Up to 8 CNC can be connected to one display (One Master CNC and 7 Slave CNC).

It can display CNC maintenance screens (including the BOOT, IPL, and alarm screens) as well as the standard CNC operation screens

## Benefits

- Cost reduction on large machines featuring several CNC

## Ordering Information

Specification	Description
A02B-0323-R722	30i-B Ethernet Display Sharing Function - Specify in Each CNC Connected via Ethernet to Shared LCD Unit
A02B-0326-R722	31i-B5 Ethernet Display Sharing Function - Specify in Each CNC Connected via Ethernet to Shared LCD Unit
A02B-0327-R722	31i-B Ethernet Display Sharing Function - Specify in Each CNC Connected via Ethernet to Shared LCD Unit
A02B-0328-R722	32i-B Ethernet Display Sharing Function - Specify in Each CNC Connected via Ethernet to Shared LCD Unit
A02B-0333-R722	35i-B Ethernet Display Sharing Function - Specify in Each CNC Connected via Ethernet to Shared LCD Unit
A02B-0334-R722	PM i-A Ethernet Display Sharing Function - Specify in Each CNC Connected via Ethernet to Shared LCD Unit

### Notice

Certain functions may require additional hardware, different CPU type or additional memory capacity or may cause compatibility issue with other functions. In case of doubt, contact your FANUC sales representative for additional information and support.

The information given in the FANUC manuals or original manufacturer documentation shall prevail. Technical data is subject to change without prior notice. No part of this document may be reproduced in any form. All rights reserved. © FANUC 2017

# 521

## Setting and Display

# Twin Display Function with Ethernet

---

## Features

The twin display function with Ethernet provides the same display and operation as the standard CNC on a secondary display unit through Ethernet connection.

## Ordering Information

Specification	Description
A02B-0323-R711	30i-B Twin Display Function with Ethernet
A02B-0326-R711	31i-B5 Twin Display Function with Ethernet
A02B-0327-R711	31i-B Twin Display Function with Ethernet
A02B-0328-R711	32i-B Twin Display Function with Ethernet
A02B-0333-R711	35i-B Twin Display Function with Ethernet
A02B-0334-R711	PM i-A Twin Display Function with Ethernet

### Notice

Certain functions may require additional hardware, different CPU type or additional memory capacity or may cause compatibility issue with other functions. In case of doubt, contact your FANUC sales representative for additional information and support.

The information given in the FANUC manuals or original manufacturer documentation shall prevail. Technical data is subject to change without prior notice. No part of this document may be reproduced in any form. All rights reserved. © FANUC 2017

# 522

## Setting and Display

# CNC Screen Dual Display Function

## Features

With the Dual CNC Screen Display Function, it is possible to display the content of the CNC screen on both the original CNC screen as well as on a PC or Panel i connected to the CNC via Ethernet or HSSB.

## Benefits

- Machine operation on large machining centers requiring 2 operator stations

## Ordering Information

Specification	Description
A02B-0323-S884	30i-B Dual Screen Display Function (Dual SDF)
A02B-0326-S884	31i-B5 Dual Screen Display Function (Dual SDF)
A02B-0327-S884	31i-B Dual Screen Display Function (Dual SDF)
A02B-0328-S884	32i-B Dual Screen Display Function (Dual SDF)
A02B-0333-R709	35i-B CNC Screen Display Function - Incl. CNC Screen Dual Display Function (Specify "Extended Drivers and Libraries" for HSSB Connection, or "Ethernet Function")
A02B-0334-R709	PM i-A CNC Screen Display Function - Includes CNC Screen Dual Display Function
A02B-0339-S884	0i-TF CNC Screen Dual Display Function
A02B-0340-S884	0i-MF CNC Screen Dual Display Function

### Notice

Certain functions may require additional hardware, different CPU type or additional memory capacity or may cause compatibility issue with other functions. In case of doubt, contact your FANUC sales representative for additional information and support.

The information given in the FANUC manuals or original manufacturer documentation shall prevail. Technical data is subject to change without prior notice. No part of this document may be reproduced in any form. All rights reserved. © FANUC 2017

# 523

## Setting and Display



# CNC Screen Display for 19" LCD

## Features

This function provides the capability to control the 19" Panel i display on the CNC.

## Benefits

- Improvement of the operation using larger screen

## Ordering Information

Specification	Description
A02B-0323-R624	30i-B CNC Screen Display Function for 19.0" LCD Unit
A02B-0326-R624	31i-B5 CNC Screen Display Function for 19.0" LCD Unit
A02B-0327-R624	31i-B CNC Screen Display Function for 19.0" LCD Unit
A02B-0328-R624	32i-B CNC Screen Display Function for 19.0" LCD Unit

### Notice

Certain functions may require additional hardware, different CPU type or additional memory capacity or may cause compatibility issue with other functions. In case of doubt, contact your FANUC sales representative for additional information and support.

The information given in the FANUC manuals or original manufacturer documentation shall prevail. Technical data is subject to change without prior notice. No part of this document may be reproduced in any form. All rights reserved. © FANUC 2017

# 524

## Setting and Display



# Enlarged CNC Screen Display for 19" LCD

## Features

This function enlarges and displays the design for 15" LCD on 19" PANELi. It is possible with this feature to magnify the size of the screen so that it is possible to better read the screen and use the full surface of the 19" screen.

## Benefits

- Improvement of the operation using large fonts sizes

## Ordering Information

Specification	Description
A02B-0323-R673	30i-B Enlarged CNC Screen Display Function for 19.0" LCD Unit
A02B-0326-R673	31i-B5 Enlarged CNC Screen Display Function for 19.0" LCD Unit
A02B-0327-R673	31i-B Enlarged CNC Screen Display Function for 19.0" LCD Unit
A02B-0328-R673	32i-B Enlarged CNC Screen Display Function for 19.0" LCD Unit

### Notice

Certain functions may require additional hardware, different CPU type or additional memory capacity or may cause compatibility issue with other functions. In case of doubt, contact your FANUC sales representative for additional information and support.

The information given in the FANUC manuals or original manufacturer documentation shall prevail. Technical data is subject to change without prior notice. No part of this document may be reproduced in any form. All rights reserved. © FANUC 2017

# 525

## Setting and Display



### Notice

Certain functions may require additional hardware, different CPU type or additional memory capacity or may cause compatibility issue with other functions. In case of doubt, contact your FANUC sales representative for additional information and support.

The information given in the FANUC manuals or original manufacturer documentation shall prevail. Technical data is subject to change without prior notice. No part of this document may be reproduced in any form. All rights reserved. © FANUC 2017

# CNC Screen Web Server Function

## Features

This function enables screen display and screen switch of CNC on a Web browser of a Tablet-type device that connects with CNC through Ethernet.

The screen which is displayed on a Web browser is the same as the screen displayed on a standard CNC Display unit.

The screen switch operation at a Web browser is reflected in a standard CNC Display unit.

## Benefits

- Provide a full screen duplication of the CNC on Web-Browser or Tablet devices

## Ordering Information

Specification	Description
A02B-0323-R728	30i-B CNC Screen Web Server Function
A02B-0326-R728	31i-B5 CNC Screen Web Server Function
A02B-0327-R728	31i-B CNC Screen Web Server Function
A02B-0328-R728	32i-B CNC Screen Web Server Function
A02B-0333-R728	35i-B CNC Screen Web Server Function
A02B-0334-R728	PM i-A CNC Screen Web Server Function
A02B-0339-R728	0i-TF CNC Screen WEB Server Function
A02B-0340-R728	0i-MF CNC Screen WEB Server Function

# 526

## Setting and Display

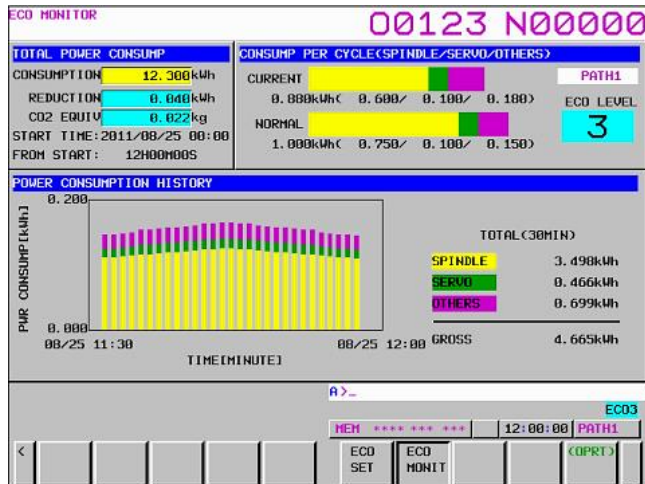

### Notice

Certain functions may require additional hardware, different CPU type or additional memory capacity or may cause compatibility issue with other functions. In case of doubt, contact your FANUC sales representative for additional information and support.

The information given in the FANUC manuals or original manufacturer documentation shall prevail. Technical data is subject to change without prior notice. No part of this document may be reproduced in any form. All rights reserved. © FANUC 2017

# Energy Saving Level Selection Function

## Features

The total power consumption of a machine is the sum of:

- Power consumption of the spindle motors
- Power consumption of the servo motors
- Power consumption in peripheral devices (coolant pump, etc.)

Suppressing torque at acceleration / deceleration in spindles, where a large power consumption is generated, can reduce whole power consumption of a machine. The drawback is that it has an influence on the machining time.

When using the Energy Level Selection Function, it is possible to switch between machining with shorter time and that with less power consumption.

In addition, the function provides screens to monitor the energy consumption of the spindles, servo motors and peripherals in real time.

## Benefits

- Monitoring of the consumption of the machine and identification of the source
- Adjustment of the ratio between productivity and energy consumption to optimize costs

## Ordering Information

Specification	Description
A02B-0323-R719	30i-B Energy Saving Level Selection Function - Usable with 30i/31i/32i/35i-B Spindle Amplifiers A06B-6220-Hxxx#H600 or A06B-6230-Hxxx#H600 or A06B-6270-Hxxx#H600
A02B-0326-R719	31i-B5 Energy Saving Level Selection Function - Usable with 30i/31i/32i/35i-B Spindle Amplifiers A06B-6220-Hxxx#H600 or A06B-6230-Hxxx#H600 or A06B-6270-Hxxx#H600
A02B-0327-R719	31i-B Energy Saving Level Selection Function - Usable with 30i/31i/32i/35i-B Spindle Amplifiers A06B-6220-Hxxx#H600 or A06B-6230-Hxxx#H600 or A06B-6270-Hxxx#H600
A02B-0328-R719	32i-B Energy Saving Level Selection Function - Usable with 30i/31i/32i/35i-B Spindle Amplifiers A06B-6220-Hxxx#H600 or A06B-6230-Hxxx#H600 or A06B-6270-Hxxx#H600
A02B-0339-R719	0i-TF Energy Saving Level Selecting Function
A02B-0340-R719	0i-MF Energy Saving Level Select Function

# 527

## Setting and Display

MACHINE STATUS HISTORY			00123 N00000		
DETECT TIME 2012/06/16 14:19:32 NON-SAVE NO. 00045			[HEAD1] NO. 094/096		
HISTORY LIST		SIGNAL INFORMATION			
NO.	DETECT TIME	MULTI SENSOR UNIT	PMC SIG.		
001	2012/06/14 14:17:39	SHCK1(X)X00000 0.0 G	X00010	00	
002	2012/06/14 14:17:41	LYJX00002 0.0 G	Y00020	00	
003	2012/06/14 14:17:42	IZJX00004 0.0 G	G00030	00	
004	2012/06/15 09:18:29*	SHCK2(X)X00006 0.0 G	F00040	00	
005	2012/06/15 09:18:30	LYJX00008 1.9 G			
006	2012/06/15 09:18:30	IZJX00010 0.0 G			
007	2012/06/15 09:18:31	CHN1 X00012 0			
008	2012/06/15 09:18:31	CHN2 X00014 0			
009	2012/06/15 09:18:32	TEMP1 X00016 0.0℃			
010	2012/06/15 09:18:33	TEMP2 X00018 0.0℃			
011	2012/06/15 09:18:33	TEMP3 X00020 0.0℃			
012	2012/06/15 09:18:33	TEMP4 X00022 0.0℃			
013	2012/06/15 09:18:34	TEMP5 X00024 0.0℃			
014	2012/06/15 09:18:34	TEMP6 X00026 0.0℃			
015	2012/06/15 09:18:34	TEMP7 X00028 0.0℃			
016	2012/06/16 14:20:19	TEMP8 X00030 0.0℃			
017	2012/06/16 14:20:20				

# Machine State Monitoring Function

## Features

This function monitors the state of the machine and when problems occur on the machine, it is possible to retrieve information such as the operation history, the position and the feedrate at the time of the problem and other useful information from the CNC memory.

The retrieved information can be used to investigate the cause of machine breakdown.

It is also possible to customize the function to monitor additional information such as shock value, abnormal load torque, the Multi-Sensor Unit (MSU) and unexpected disturbance torque detection.

When a problem occurs on the machine, such as a spindle collision, the ladder program notifies the CNC; when the CNC is notified it saves the information related to the event in the CNC memory for later retrieval.

The CNC can save a maximum of 100 events in its memory.

## Benefits

- Collection of key data to help the investigation of problems on machine
- Reduction of the breakdown time and better support of the maintenance teams
- Overall increase of the productivity

## Ordering Information

Specification	Description
A02B-0323-R717	30i-B Machine State Monitoring Function
A02B-0326-R717	31i-B5 Machine State Monitoring Function
A02B-0327-R717	31i-B Machine State Monitoring Function
A02B-0328-R717	32i-B Machine State Monitoring Function
A02B-0333-R717	35i-B Machine State Monitoring Function
A02B-0339-R717	0i-TF Machine State Monitoring Function
A02B-0340-R717	0i-MF Machine State Monitoring Function

### Notice

Certain functions may require additional hardware, different CPU type or additional memory capacity or may cause compatibility issue with other functions. In case of doubt, contact your FANUC sales representative for additional information and support.

The information given in the FANUC manuals or original manufacturer documentation shall prevail. Technical data is subject to change without prior notice. No part of this document may be reproduced in any form. All rights reserved. © FANUC 2017



# 528

## Setting and Display

MACHINE CONFIGURATION SELECTING 00123 N00000

PARAMETER SELECT MACHINE CONF: No. 1 MILLING\_CON1

	No. 3	No. 4	No. 5	No. 6
	MILLING_CON3	TURNING_CON1	TURNING_CON2	TURNING_CON3
01022				
X	0	0	0	0
Y	0	0	0	0
Z	0	0	0	0
C	0	0	0	0
B	0	0	0	0
A	0	0	0	0
19665	00000000	00000000	00000000	00000000
19666	0.000	0.000	0.000	0.000

EDIT \*\*\*\* \*+\* \*+\* 12:00:00

< NO. SRH ON: 1 OFF: 0 +INPUT INPUT READ PUNCH

# Machine Configuration Selecting Function

## Features

The Machine Configuration Selecting function allows an easy switching of machine configuration when the machine needs to adapt to different production environments or batch.

Ten sets of parameters for these machine configurations can be set on machine configuration selecting screen.

## Benefits

- Decreases the time required to switch between different production batches and setups
- Increases the efficiency and the productivity of the machine

## Ordering Information

Specification	Description
A02B-0323-R700	30i-B Machine Configuration Selection Function
A02B-0326-R700	31i-B5 Machine Configuration Selection Function
A02B-0327-R700	31i-B Machine Configuration Selection Function
A02B-0328-R700	32i-B Machine Configuration Selection Function

### Notice

Certain functions may require additional hardware, different CPU type or additional memory capacity or may cause compatibility issue with other functions. In case of doubt, contact your FANUC sales representative for additional information and support.

The information given in the FANUC manuals or original manufacturer documentation shall prevail. Technical data is subject to change without prior notice. No part of this document may be reproduced in any form. All rights reserved. © FANUC 2017

# 529

## Setting and Display

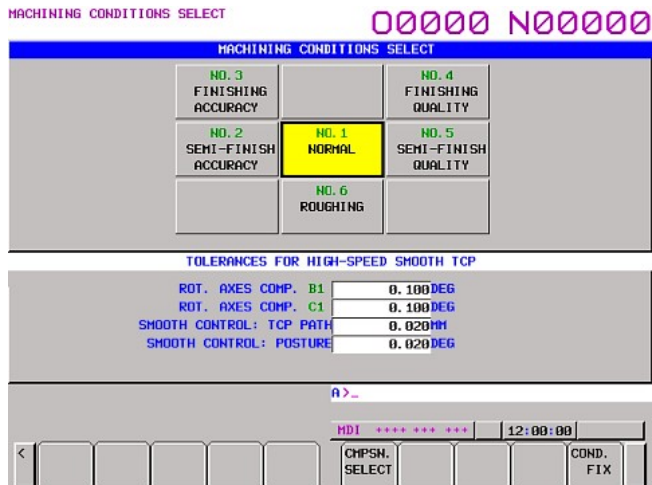

# 5-Axis Machining Condition Setting Function

## Features

The 5-axis Machining Condition Setting provides the capability to change the parameters of machining conditions according to the machining situation when an operator selects one among six machining conditions.

This function provides a selection screen and a setting screen. The selecting screen is a screen for the operator, and the setting screen is a screen for the machine builder.

## Note

This function cannot be used together with the following functions:

- Machining condition selecting function
- Machining quality level adjustment

## Benefits

- Decreases the time required to switch between different production batches and setups of 5-axis machines
- Increases the efficiency and the productivity of the machine

## Ordering Information

Specification	Description
A02B-0323-R721	30i-B 5-Axis Machinng Condition Setting Function
A02B-0326-R721	31i-B5 5-Axis Machinng Condition Setting Function

### Notice

Certain functions may require additional hardware, different CPU type or additional memory capacity or may cause compatibility issue with other functions. In case of doubt, contact your FANUC sales representative for additional information and support.

The information given in the FANUC manuals or original manufacturer documentation shall prevail. Technical data is subject to change without prior notice. No part of this document may be reproduced in any form. All rights reserved. © FANUC 2017

# 530

## Setting and Display

# Main Menu Screen

## Features

The design and title string of the icon and the string of category in the main menu screen can be customized by using the PC application

The main menu screen can register the often used screens and the registered screen is displayed by icon. The objective screen can be displayed by selecting the icon. For the feature of each MTB, there is a demand to customize the design and title of icon.

## Benefits

The following items of the main menu can be customized by using the PC-application.

1. The design of the icon
2. The title string of the icon
3. The string of the category
4. The default order of the icons

Main menu screen customization tool (A08B-9010-J525#ZZ11 is necessary

This function cannot be used with machine operation menu function (S844)

This function cannot be used with 8.4inch LCD

This function cannot be used with 19inch LCD

For 10.4inch LCD: A02B-0323-J541#60VN edition 07.00 or later

For 10.4inch tybe B, 15inch LCD:

- A02B-0323-J587#60VP edition 11.00 or later
- A02B-0323-J588#60VQ edition 07.00 or later

## Ordering Information

Specification	Description
A02B-0323-R848	30i-B Main Menu Screen - Customising Function
A02B-0326-R848	31i-B5 Main Menu Screen - Customising Function
A02B-0327-R848	31i-B Main Menu Screen - Customising Function
A02B-0328-R848	32i-B Main Menu Screen - Customising Function
A02B-0339-R848	0i-TF Main Menu Screen Customisation Function

### Notice

Certain functions may require additional hardware, different CPU type or additional memory capacity or may cause compatibility issue with other functions. In case of doubt, contact your FANUC sales representative for additional information and support.

The information given in the FANUC manuals or original manufacturer documentation shall prevail. Technical data is subject to change without prior notice. No part of this document may be reproduced in any form. All rights reserved. © FANUC 2017

# 531

Specification	Description
A02B-0340-R848	0i-MF Main Menu Screen Customization Function

#### Notice

Certain functions may require additional hardware, different CPU type or additional memory capacity or may cause compatibility issue with other functions. In case of doubt, contact your FANUC sales representative for additional information and support.

The information given in the FANUC manuals or original manufacturer documentation shall prevail. Technical data is subject to change without prior notice. No part of this document may be reproduced in any form. All rights reserved. © FANUC 2017



# 533

## Setting and Display

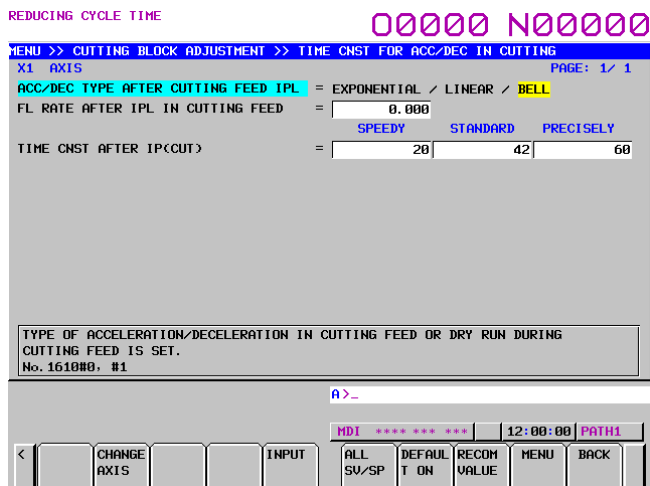

### Notice

Certain functions may require additional hardware, different CPU type or additional memory capacity or may cause compatibility issue with other functions. In case of doubt, contact your FANUC sales representative for additional information and support.

The information given in the FANUC manuals or original manufacturer documentation shall prevail. Technical data is subject to change without prior notice. No part of this document may be reproduced in any form. All rights reserved. © FANUC 2017

# Machine Setting Switching Function

## Features

Up to three setting patterns related to reducing cycle time can be selected by an operator. Switching to the setting pattern that corresponds to the machining conditions can be done easily. The effective setting pattern can be switched by screen operation, G08.1 command or signal input.

## Benefits

- Set parameters for different machining conditions easily

## Ordering Information

Specification	Description
A02B-0323-R412	30i-B Machine Setting Switching Function
A02B-0326-R412	31i-B5 Machine Setting Switching Function
A02B-0327-R412	31i-B Machine Setting Switching Function
A02B-0328-R412	32i-B Machine Setting Switching Function

# 534

## Functions

# Data Input/Output

---

This section of the catalogue contains the functions related to Data Input / Output.

Some of the functions detailed in the catalogue:

- RS232 interface
- Data Server
- Messaging
- Automatic Backup
- Etc.

### Notice

Certain functions may require additional hardware, different CPU type or additional memory capacity or may cause compatibility issue with other functions. In case of doubt, contact your FANUC sales representative for additional information and support.

The information given in the FANUC manuals or original manufacturer documentation shall prevail. Technical data is subject to change without prior notice. No part of this document may be reproduced in any form. All rights reserved. © FANUC 2017

# 535

## Data Input/Output

# RS232C Interface

## Features

The Reader / Puncher Interface option enables the on board RS-232 port to be able to input / output files to / from the CNC.

This function is a basic function in FANUC Series 0i-F.

## Benefits

- Download / Upload programs in background edit mode
- Output data to external PC for SPC charts
- Drip feed large programs
- Output data to serial printer
- No need to un-hook peripheral devices
- User selectable ports

## Ordering Information

Specification	Description
A02B-0323-J900	30i-B Reader/Puncher Interface for 1 Channel
A02B-0323-J901	30i-B Reader/Puncher Interface for 2 Channels
A02B-0326-J900	31i-B5 Reader/Puncher Interface for 1 Channel
A02B-0326-J901	31i-B5 Reader/Puncher Interface for 2 Channels
A02B-0327-J900	31i-B Reader/Puncher Interface for 1 Channel
A02B-0327-J901	31i-B Reader/Puncher Interface for 2 Channels
A02B-0328-J900	32i-B Reader/Puncher Interface for 1 Channel
A02B-0328-J901	32i-B Reader/Puncher Interface for 2 Channels

### Notice

Certain functions may require additional hardware, different CPU type or additional memory capacity or may cause compatibility issue with other functions. In case of doubt, contact your FANUC sales representative for additional information and support.

The information given in the FANUC manuals or original manufacturer documentation shall prevail. Technical data is subject to change without prior notice. No part of this document may be reproduced in any form. All rights reserved. © FANUC 2017



# 536

## Data Input/Output

# RS232C Interface Expansion of Receiving Buffer

## Features

Expands the receiving buffer of the RS-232 Reader/Puncher interface from the default size of 0.5K bytes, to 2K bytes. Expanded buffer size enables more stable automatic operation by drip feed, in moderately demanding machining applications.

## Benefits

- Expanded buffer capacity prevents intermittent delays or loss of RS-232 serial data during operation or storage

## Ordering Information

Specification	Description
A02B-0323-R511	30i-B Reader / Puncher Interface Expansion of Receiving Buffer
A02B-0326-R511	31i-B5 Reader / Puncher Interface Expansion of Receiving Buffer
A02B-0327-R511	31i-B Reader / Puncher Interface Expansion of Receiving Buffer
A02B-0328-R511	32i-B Reader / Puncher Interface Expansion of Receiving Buffer

### Notice

Certain functions may require additional hardware, different CPU type or additional memory capacity or may cause compatibility issue with other functions. In case of doubt, contact your FANUC sales representative for additional information and support.

The information given in the FANUC manuals or original manufacturer documentation shall prevail. Technical data is subject to change without prior notice. No part of this document may be reproduced in any form. All rights reserved. © FANUC 2017

# 537

## Data Input/Output

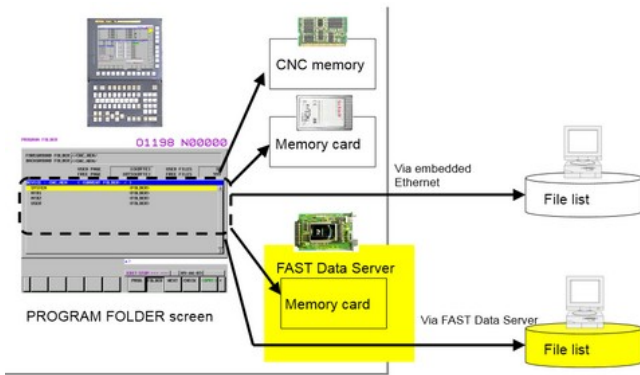

## Fast Data Server

### Features

The Data Server / Fast Data Server consists of an embedded memory card and an Ethernet connection on the CNC. The Data Server allows files to be transferred from a host computer to the CNC memory, or to the memory card on the Data server. Part programs may also be executed directly either from the network or the Compact Flash card on the Data Server.

### Benefits

- Manage part programs for multiple machines at a central location.
- Store and reliably execute large part programs without taking up part program storage on the CNC.

### Ordering Information

Specification	Description
A02B-0323-S737	30i-B Data Server Function - Incl. Data Server Buffer Mode
A02B-0326-S737	31i-B5 Data Server Function - Incl. Data Server Buffer Mode
A02B-0327-S737	31i-B Data Server Function - Incl. Data Server Buffer Mode
A02B-0328-S737	32i-B Data Server Function - Incl. Data Server Buffer Mode
A02B-0339-S737	0i-TF Data Server Function
A02B-0340-S737	0i-MF Data Server Function

#### Notice

Certain functions may require additional hardware, different CPU type or additional memory capacity or may cause compatibility issue with other functions. In case of doubt, contact your FANUC sales representative for additional information and support.

The information given in the FANUC manuals or original manufacturer documentation shall prevail. Technical data is subject to change without prior notice. No part of this document may be reproduced in any form. All rights reserved. © FANUC 2017

# 538

## Data Input/Output

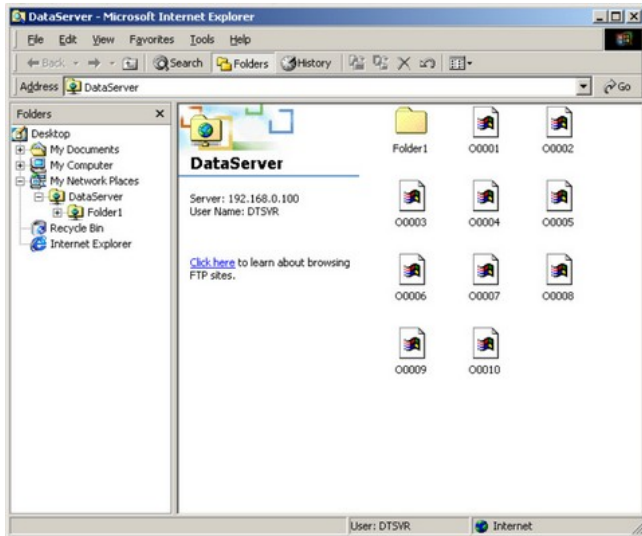

### Notice

Certain functions may require additional hardware, different CPU type or additional memory capacity or may cause compatibility issue with other functions. In case of doubt, contact your FANUC sales representative for additional information and support.

The information given in the FANUC manuals or original manufacturer documentation shall prevail. Technical data is subject to change without prior notice. No part of this document may be reproduced in any form. All rights reserved. © FANUC 2017

# Data Server Explorer Connection

## Features

The following functions are added to FTP Server function of Data Server.

- Increase of FTP Server connections.
- Connection with Windows Explorer
- Addition of maintenance screen for FTP server

## Benefits

- Simplification of the handling of large program over FTP
- Improvement of the machining productivity

## Ordering Information

Specification	Description
A02B-0323-R953	30i-B Data Server Explorer Connection Function
A02B-0326-R953	31i-B5 Data Server Explorer Connection Function
A02B-0327-R953	31i-B Data Server Explorer Connection Function
A02B-0328-R953	32i-B Data Server Explorer Connection Function
A02B-0339-R953	0i-TF Data Server Explorer Connection Function
A02B-0340-R953	0i-MF Data Server Explorer Connection Function

# 539

## Data Input/Output

# External Tool Offset

---

## Features

The External Tool Offset function provides signals for changing the tool compensation value via the PMC. When the offset number is specified by a part program, data input from the PMC is added to the offset value. The offset value can also be used as input data itself by specifying the input signal.

If the tool compensation value is externally input when offset number 0 specified in a part program (an offset cancel) in the lathe turning machine, the workpiece coordinate system shifts by the entered quantity.

This function is a basic function in FANUC Series 0i-F.

## Benefits

- Simplification of the machine operation
- Improvement of the machining productivity

## Ordering Information

Specification	Description
A02B-0323-J910	30i-B External Tool Offset
A02B-0326-J910	31i-B5 External Tool Offset
A02B-0327-J910	31i-B External Tool Offset
A02B-0328-J910	32i-B External Tool Offset

### Notice

Certain functions may require additional hardware, different CPU type or additional memory capacity or may cause compatibility issue with other functions. In case of doubt, contact your FANUC sales representative for additional information and support.

The information given in the FANUC manuals or original manufacturer documentation shall prevail. Technical data is subject to change without prior notice. No part of this document may be reproduced in any form. All rights reserved. © FANUC 2017

# 540

## Data Input/Output

# External Machine Zero Point Shift

## Features

The machine coordinate system can be externally shifted by inputting a shift value.

When the shift value is input, compensation is immediately applied to the corresponding axis and the axis moves. The position accuracy can be improved by combining this function with sensors.

The specification to shift the axis is the same as the external workpiece coordinate system shift. The compensation value is specified in signals ED0 to ED15 using a binary code ranging from 0 to  $\pm 9999$ . This compensation value must be specified in absolute value. The value that the machine actually moves at input is the difference from the previously stored value.

This function is a basic function in FANUC Series 0i-F.

## Benefits

- Simplification of the machine operation
- Improvement of the machining productivity

## Ordering Information

Specification	Description
A02B-0323-J912	30i-B External Machine Zero Point Shift
A02B-0326-J912	31i-B5 External Machine Zero Point Shift
A02B-0327-J912	31i-B External Machine Zero Point Shift
A02B-0328-J912	32i-B External Machine Zero Point Shift

### Notice

Certain functions may require additional hardware, different CPU type or additional memory capacity or may cause compatibility issue with other functions. In case of doubt, contact your FANUC sales representative for additional information and support.

The information given in the FANUC manuals or original manufacturer documentation shall prevail. Technical data is subject to change without prior notice. No part of this document may be reproduced in any form. All rights reserved. © FANUC 2017

# 541

## Data Input/Output

# External Message

## Features

The external operator message function allows the transfer of messages for the operator from the PMC to the CNC display screen. The operator messages can be cleared by the PMC. Up to 256 characters can be sent in a single operator message, or up to 4 messages of 63 characters can be displayed at the same time. A parameter setting controls the range of the message numbers and their display form.

- When the parameter is set to 0  
The message numbers 0 to 999 can be sent. The message numbers 0 to 99 are displayed along with the message. To distinguish these alarms from other alarms, the CNC displays them by adding 2000 to an alarm number. When a message from 100 to 999 is displayed, the message number is not displayed; only its text is displayed.
- When the parameter is set to 1  
The message numbers 0 to 4095 can be sent. The message numbers 0 to 99 are displayed along with the message. The CNC displays them with prefix characters 'EX' to an alarm for display. When a message number from 100 to 4095 is displayed, the message number is not displayed; only its text is displayed.

This function is a basic function in FANUC Series 0i-F.

## Benefits

- Simplification of the machine operation
- Improvement of the communication with the operator
- Improvement of the machining productivity

## Ordering Information

Specification	Description
A02B-0323-J911	30i-B External Message
A02B-0326-J911	31i-B5 External Message
A02B-0327-J911	31i-B External Message
A02B-0328-J911	32i-B External Message

### Notice

Certain functions may require additional hardware, different CPU type or additional memory capacity or may cause compatibility issue with other functions. In case of doubt, contact your FANUC sales representative for additional information and support.

The information given in the FANUC manuals or original manufacturer documentation shall prevail. Technical data is subject to change without prior notice. No part of this document may be reproduced in any form. All rights reserved. © FANUC 2017

# 542

## Data Input/Output

# External Data Input

## Features

The External Data Input function is a collection of options that enables the PMC to send data to the CNC to perform a desired operation. The external data input function includes the following capabilities:

- External tool offset - Changing the tool offset value from the PMC.
- External program number search - Selecting the part program number to activate by the PMC.
- External workpiece coordinate system shift - Modifying the shift value by the PMC.
- External machine zero point shift - Shifting the machine zero point on an axis by the PMC.
- Extended external machine zero point shift - Shifting the machine zero point on all axes by PMC.
- External alarm message -The PMC can send an ALARM message to the CNC.
- External operator message -The PMC can send an Operator message to the CNC
- Assignment of machined parts count and required parts count data -The PMC can preset the required parts count and machined parts count to a value in the range 0 to 9999.

This function is a basic function in FANUC Series 0i-F.

## Benefits

- Simplification of the machine operation
- Improvement of the machining productivity

## Ordering Information

Specification	Description
A02B-0323-J913	30i-B External Data Input - Incl. External Message, External Tool Offset, External Machine Zero Point Shift, External Program Number Search
A02B-0326-J913	31i-B5 External Data Input - Incl. External Message, External Tool Offset, External Machine Zero Point Shift, External Program Number Search
A02B-0327-J913	31i-B External Data Input - Incl. External Message, External Tool Offset, External Machine Zero Point Shift, External Program Number Search
A02B-0328-J913	32i-B External Data Input - Incl. External Message, External Tool Offset, External Machine Zero Point Shift, External Program Number Search

### Notice

Certain functions may require additional hardware, different CPU type or additional memory capacity or may cause compatibility issue with other functions. In case of doubt, contact your FANUC sales representative for additional information and support.

The information given in the FANUC manuals or original manufacturer documentation shall prevail. Technical data is subject to change without prior notice. No part of this document may be reproduced in any form. All rights reserved. © FANUC 2017

# 543

## Data Input/Output

# Power Mate CNC Manager

## Features

When the servo amplifier unit is used as an additional (slave) axis of the CNC, the power mate CNC manager enables the display and setting of data from the CNC. Up to eight slave units can be connected.

The Power Mate CNC manager supports the following functions:

- Current position display (absolute/machine coordinate)
- Parameter display and setting
- Diagnosis
- System configuration screen
- Alarm

This function is a basic function in FANUC Series 0i-F.

## Benefits

- Cost effective way to configure/drive auxilliary axis

## Ordering Information

Specification	Description
A02B-0323-J674	30i-B Power Mate CNC Manager
A02B-0326-J674	31i-B5 Power Mate CNC Manager
A02B-0327-J674	31i-B Power Mate CNC Manager
A02B-0328-J674	32i-B Power Mate CNC Manager
A02B-0333-J674	35i-B Power Mate CNC Manager
A02B-0334-J674	PM i-A Power Mate CNC Manager

### Notice

Certain functions may require additional hardware, different CPU type or additional memory capacity or may cause compatibility issue with other functions. In case of doubt, contact your FANUC sales representative for additional information and support.

The information given in the FANUC manuals or original manufacturer documentation shall prevail. Technical data is subject to change without prior notice. No part of this document may be reproduced in any form. All rights reserved. © FANUC 2017



# 544

## Data Input/Output

# External I/O Device Control

---

## Features

Part program registration and punch can be commanded externally.

This function is a basic function in FANUC Series 0i-F.

## Benefits

- Operator can conveniently upload/download part programs from host device
- No need to push read/punch button on CNC
- Read/Punch can be activated by external device such as from enter button on laptop
- Permits better part program control from CAM room
- Easy to maintain one master part program

## Ordering Information

Specification	Description
A02B-0323-J902	30i-B External I/O Device Control
A02B-0326-J902	31i-B5 External I/O Device Control
A02B-0327-J902	31i-B External I/O Device Control
A02B-0328-J902	32i-B External I/O Device Control

### Notice

Certain functions may require additional hardware, different CPU type or additional memory capacity or may cause compatibility issue with other functions. In case of doubt, contact your FANUC sales representative for additional information and support.

The information given in the FANUC manuals or original manufacturer documentation shall prevail. Technical data is subject to change without prior notice. No part of this document may be reproduced in any form. All rights reserved. © FANUC 2017

# 545

## Data Input/Output

# One Touch Macro Call

## Features

This function enables the CNC to perform a complex macro operation at the push of a button.

By pressing a switch on the machine, the following three operations can be performed with minimum ladder modifications:

- Switching to the MEM mode.
- Execution of macro programs stored in memory.
- Return to the mode before execution. The program selected before execution is automatically selected.

This function is enabled only in the reset state. This means that this function cannot be used during automatic operation (during automatic operation halt and automatic operation stop periods as well).

## Benefits

- Simplification of the machine operation
- Improvement of the machining productivity

## Ordering Information

Specification	Description
A02B-0323-S655	30i-B One Touch Macro Call Function
A02B-0326-S655	31i-B5 One Touch Macro Call Function
A02B-0327-S655	31i-B One Touch Macro Call Function
A02B-0328-S655	32i-B One Touch Macro Call Function
A02B-0339-S655	0i-TF One Touch Macro Call Function
A02B-0340-S655	0i-MF One Touch Macro CallL Function

### Notice

Certain functions may require additional hardware, different CPU type or additional memory capacity or may cause compatibility issue with other functions. In case of doubt, contact your FANUC sales representative for additional information and support.

The information given in the FANUC manuals or original manufacturer documentation shall prevail. Technical data is subject to change without prior notice. No part of this document may be reproduced in any form. All rights reserved. © FANUC 2017

# 546

## Data Input/Output

# Automatic Data Backup

## Features

Enables automatic backup of battery-backed SRAM memory contents to the control's Flash ROM memory. In the event of SRAM memory loss, maintenance personnel can immediately recover data from a saved backup.

This function is a basic function in FANUC Series 0i-F.

## Benefits

- Up to three backup copies can be made/maintained.
- Backup may be performed at set interval and/or when E-Stop occurs.
- One backup copy may be protected for saving of original data/settings.
- Backup of CNC part programs in FROM memory may be included.

## Ordering Information

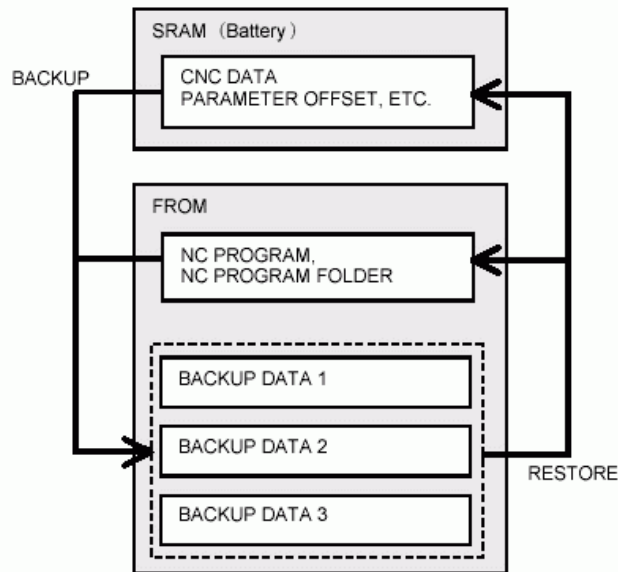

Specification	Description
A02B-0323-H510#B10	30i-B Automatic Data Back-up, 1 Set of Back-up Data, SRAM
A02B-0323-H510#B11	30i-B Automatic Data Back-up, 1 Set of Back-up Data, SRAM + Part Programs
A02B-0323-H510#B20	30i-B Automatic Data Back-up, 2 Sets of Back-up Data, SRAM
A02B-0323-H510#B21	30i-B Automatic Data Back-up, 2 Sets of Back-up Data, SRAM + Part Programs
A02B-0323-H510#B30	30i-B Automatic Data Back-up, 3 Sets of Back-up Data, SRAM
A02B-0323-H510#B31	30i-B Automatic Data Back-up, 3 Sets of Back-up Data, SRAM + Part Programs
A02B-0326-H510#B10	31i-B5 Automatic Data Back-up, 1 Set of Back-up Data, SRAM
A02B-0326-H510#B11	31i-B5 Automatic Data Back-up, 1 Set of Back-up Data, SRAM + Part Programs
A02B-0326-H510#B20	31i-B5 Automatic Data Back-up, 2 Sets of Back-up Data, SRAM
A02B-0326-H510#B21	31i-B5 Automatic Data Back-up, 2 Sets of Back-up Data, SRAM + Part Programs
A02B-0326-H510#B30	31i-B5 Automatic Data Back-up, 3 Sets of Back-up Data, SRAM
A02B-0326-H510#B31	31i-B5 Automatic Data Back-up, 3 Sets of Back-up Data, SRAM + Part Programs
A02B-0327-H510#B10	31i-B Automatic Data Back-up, 1 Set of Back-up Data, SRAM
A02B-0327-H510#B11	31i-B Automatic Data Back-up, 1 Set of Back-up Data, SRAM + Part Programs
A02B-0327-H510#B20	31i-B Automatic Data Back-up, 2 Sets of Back-up Data, SRAM
A02B-0327-H510#B21	31i-B Automatic Data Back-up, 2 Sets of Back-up Data, SRAM + Part Programs
A02B-0327-H510#B30	31i-B Automatic Data Back-up, 3 Sets of Back-up Data, SRAM
A02B-0327-H510#B31	31i-B Automatic Data Back-up, 3 Sets of Back-up Data, SRAM + Part Programs
A02B-0328-H510#B10	32i-B Automatic Data Back-up, 1 Set of Back-up Data, SRAM
A02B-0328-H510#B11	32i-B Automatic Data Back-up, 1 Set of Back-up Data, SRAM + Part Programs

### Notice

Certain functions may require additional hardware, different CPU type or additional memory capacity or may cause compatibility issue with other functions. In case of doubt, contact your FANUC sales representative for additional information and support.

The information given in the FANUC manuals or original manufacturer documentation shall prevail. Technical data is subject to change without prior notice. No part of this document may be reproduced in any form. All rights reserved. © FANUC 2017

Specification	Description
A02B-0328-H510#B20	32i-B Automatic Data Back-up, 2 Sets of Back-up Data, SRAM
A02B-0328-H510#B21	32i-B Automatic Data Back-up, 2 Sets of Back-up Data, SRAM + Part Programs
A02B-0328-H510#B30	32i-B Automatic Data Back-up, 3 Sets of Back-up Data, SRAM
A02B-0328-H510#B31	32i-B Automatic Data Back-up, 3 Sets of Back-up Data, SRAM + Part Programs
A02B-0333-H510#B10	35i-B Automatic Data Back-up, 1 Set of Back-up Data, SRAM
A02B-0333-H510#B11	35i-B Automatic Data Back-up, 1 Set of Back-up Data, SRAM + Part Programs
A02B-0333-H510#B20	35i-B Automatic Data Back-up, 2 Sets of Back-up Data, SRAM
A02B-0333-H510#B21	35i-B Automatic Data Back-up, 2 Sets of Back-up Data, SRAM + Part Programs
A02B-0333-H510#B30	35i-B Automatic Data Back-up, 3 Sets of Back-up Data, SRAM
A02B-0333-H510#B31	35i-B Automatic Data Back-up, 3 Sets of Back-up Data, SRAM + Part Programs
A02B-0334-H510#B10	PM i-A Automatic Data Back-up, 1 Set of Back-up Data, SRAM
A02B-0334-H510#B11	PM i-A Automatic Data Back-up, 1 Set of Back-up Data, SRAM + Part Programs
A02B-0334-H510#B20	PM i-A Automatic Data Back-up, 2 Sets of Back-up Data, SRAM
A02B-0334-H510#B21	PM i-A Automatic Data Back-up, 2 Sets of Back-up Data, SRAM + Part Programs
A02B-0334-H510#B30	PM i-A Automatic Data Back-up, 3 Sets of Back-up Data, SRAM
A02B-0334-H510#B31	PM i-A Automatic Data Back-up, 3 Sets of Back-up Data, SRAM + Part Programs

#### Notice

Certain functions may require additional hardware, different CPU type or additional memory capacity or may cause compatibility issue with other functions. In case of doubt, contact your FANUC sales representative for additional information and support.

The information given in the FANUC manuals or original manufacturer documentation shall prevail. Technical data is subject to change without prior notice. No part of this document may be reproduced in any form. All rights reserved. © FANUC 2017

# 548

## Functions

## PMC System

---

This section of the catalogue contains the functions related to the Programmable Machine Controller (PMC) which is a Programmable Logic Controller integrated in the CNC.

Some of the functions detailed in the catalogue:

- General overview
- Multi-path PMC
- Symbols and messaging
- Step sequence
- Function Blocks
- Etc.

### Notice

Certain functions may require additional hardware, different CPU type or additional memory capacity or may cause compatibility issue with other functions. In case of doubt, contact your FANUC sales representative for additional information and support.

The information given in the FANUC manuals or original manufacturer documentation shall prevail. Technical data is subject to change without prior notice. No part of this document may be reproduced in any form. All rights reserved. © FANUC 2017

# 549

## PMC System

# PMC Ladder Function

## Features

The Programmable Machine Controller (PMC) which is integrated in the CNC is sizable to match the requirement of the machine.

PMC program sizes of up to 300,000 steps (depending on the CNC model) can be defined. Please refer to the ordering information to identify the sizes available per CNC model.

## Benefits

- Customization of the PMC program size
- Adaptation to the machine and process requirements

## Ordering Information

Specification	Description
A02B-0323-H990#100K	30i-B 1st-Path PMC Ladder Function, 100000 Steps
A02B-0323-H990#300K	30i-B 1st Path PMC Ladder Function 300000 Steps
A02B-0323-H990#32K	30i-B 1st-Path PMC Ladder Function, 32000 Steps, up to 384 kB of Total PMC Program Memory
A02B-0323-H990#64K	30i-B 1st-Path PMC Ladder Function, 64000 Steps, up to 768 kB of Total PMC Program Memory
A02B-0326-H990#100K	31i-B5 1st-Path PMC Ladder Function, 100000 Steps
A02B-0326-H990#300K	31i-B5 1st Path PMC Ladder Function 300000 Steps
A02B-0326-H990#32K	31i-B5 1st Path PMC Ladder Function, 32000 Steps, up to 384 kB of total PMC Program Memory
A02B-0326-H990#64K	31i-B5 1st Path PMC Ladder Function, 64000 Steps, up to 768 kB of total PMC Program Memory
A02B-0327-H990#100K	31i-B 1st-Path PMC Ladder Function, 100000 Steps
A02B-0327-H990#300K	31i-B 1st Path PMC Ladder Function, 300000 Steps
A02B-0327-H990#32K	31i-B 1st-Path PMC Ladder Function, 32000 Steps, up to 384 kB of total PMC Program Memory
A02B-0327-H990#64K	31i-B 1st Path PMC Ladder Function, 64000 Steps, up to 768 kB of total PMC Program Memory
A02B-0328-H990#100K	32i-B 1st-Path PMC Ladder Function, 100000 Steps
A02B-0328-H990#300K	32i-B 1st Path PMC Ladder Function, 300000 steps
A02B-0328-H990#32K	32i-B 1st-Path PMC Ladder Function, 32000 Steps, up to 384 kB of total PMC Program Memory

### Notice

Certain functions may require additional hardware, different CPU type or additional memory capacity or may cause compatibility issue with other functions. In case of doubt, contact your FANUC sales representative for additional information and support.

The information given in the FANUC manuals or original manufacturer documentation shall prevail. Technical data is subject to change without prior notice. No part of this document may be reproduced in any form. All rights reserved. © FANUC 2017

Specification	Description
A02B-0328-H990#64K	32i-B 1st-Path PMC Ladder Function, 64000 Steps, up to 768 kB of total PMC Program Memory
A02B-0333-H990#100K	35i-B 1st-Path PMC Ladder Function, 100000 Steps
A02B-0333-H990#300K	35i-B 1st Path PMC Ladder Function, 300000 steps
A02B-0333-H990#32K	35i-B 1st-Path PMC Ladder Function, 32000 Steps, up to 384 kB of Total PMC Program Memory
A02B-0333-H990#64K	35i-B 1st-Path PMC Ladder Function, 64000 Steps, up to 768 kB of Total PMC Program Memory
A02B-0334-H990#100K	PM i-A PMC Ladder Function, 100000 Steps, 1 MB Program Memory
A02B-0334-H990#300K	PM i-A PMC Ladder Function, 300000 Steps, 3 MB PMC Program Memory
A02B-0334-H990#32K	PM i-A PMC Ladder Function, 32000 Steps, 384 kB PMC Program Memory
A02B-0334-H990#64K	PM i-A PMC Ladder Function, 64000 Steps, 768 kB PMC Program Memory
A02B-0339-H990#100K	0i-TF PMC Ladder Function: 100000 Steps
A02B-0339-H990#24K	0i-TF Type 3 PMC Ladder Function, 24000 Steps
A02B-0339-H990#32K	0i-TF PMC Ladder Function: 32000 Steps
A02B-0339-H990#64K	0i-TF PMC Ladder Function: 64000 Steps
A02B-0339-H990#8K	0i-TF Type 3 PMC Ladder Function, 8000 Steps
A02B-0340-H990#100K	0i-MF PMC Ladder Function: 100000 Steps
A02B-0340-H990#32K	0i-MF PMC Ladder Function: 32000 Steps
A02B-0340-H990#64K	0i-MF PMC Ladder Function: 64000 Steps

## Notice

Certain functions may require additional hardware, different CPU type or additional memory capacity or may cause compatibility issue with other functions. In case of doubt, contact your FANUC sales representative for additional information and support.

The information given in the FANUC manuals or original manufacturer documentation shall prevail. Technical data is subject to change without prior notice. No part of this document may be reproduced in any form. All rights reserved. © FANUC 2017

# 551

## PMC System

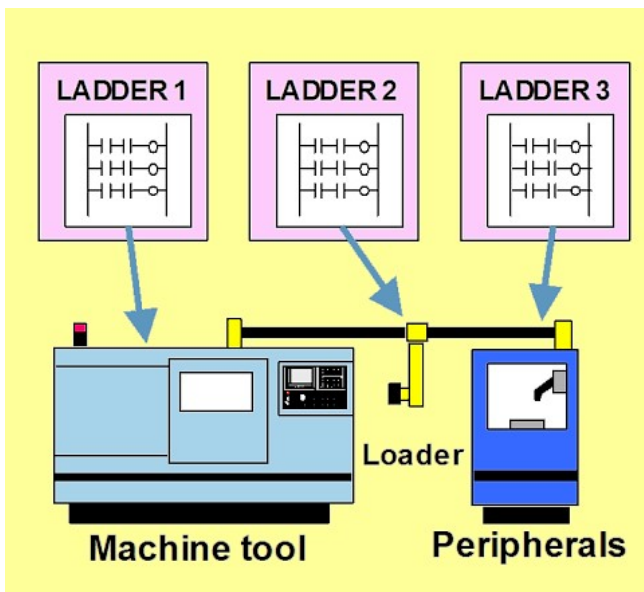

### Notice

Certain functions may require additional hardware, different CPU type or additional memory capacity or may cause compatibility issue with other functions. In case of doubt, contact your FANUC sales representative for additional information and support.

The information given in the FANUC manuals or original manufacturer documentation shall prevail. Technical data is subject to change without prior notice. No part of this document may be reproduced in any form. All rights reserved. © FANUC 2017

## Multi-Path PMC Function

### Features

The Programmable Machine Controller (PMC) usually runs one single program. In order to extend the processing capabilities of the PMC, it is possible to increase the number of concurrent PMC programs running at the same time to 3 or 5.

Each of the program or path can exchange data with the other paths using shared data and can control specific parts of the process. For instance, one path can be allocated to the machine itself, one to the auxiliary functions and the 3rd one to the loading / unloading system.

### Benefits

- Increase of the processing and structuring capacity of the PMC
- Possibility to associate separate PMC paths with process sub-systems
- Simplification of the maintenance of the machine
- Possibility to design the PMC programs with different developers teams

### Ordering Information

Specification	Description
A02B-0323-R855#3	30i-B Multi-Path PMC Function (3 Paths)
A02B-0323-R855#5	30i-B Multi-Path PMC Function (5 Paths)
A02B-0326-R855#3	31i-B5 Multi-Path PMC Function (3 Paths)
A02B-0326-R855#5	31i-B5 Multi-Path PMC Function (5 Paths)
A02B-0327-R855#3	31i-B Multi-Path PMC Function (3 Paths)
A02B-0327-R855#5	31i-B Multi-Path PMC Function (5 Paths)
A02B-0328-R855#3	32i-B Multi-Path PMC Function (3 Paths)
A02B-0328-R855#5	32i-B Multi-Path PMC Function (5 Paths)
A02B-0333-R855#3	35i-B Multi-Path PMC Function (3 Paths)
A02B-0333-R855#5	35i-B Multi-Path PMC Function (5 Paths)
A02B-0334-R855#3	PM i-A Multi-Path PMC Function (3 Paths)
A02B-0334-R855#5	PM i-A Multi-Path PMC Function (5 Paths)
A02B-0339-R855#3	0i-TF Multi-Path PMC Function (3 Paths)
A02B-0340-R855#3	0i-MF Multi-Path PMC Function (3 Paths)



# 552

## PMC System



### Notice

Certain functions may require additional hardware, different CPU type or additional memory capacity or may cause compatibility issue with other functions. In case of doubt, contact your FANUC sales representative for additional information and support.

The information given in the FANUC manuals or original manufacturer documentation shall prevail. Technical data is subject to change without prior notice. No part of this document may be reproduced in any form. All rights reserved. © FANUC 2017

# PMC Symbol, Comment and Message Area Expansion

## Features

When the Extension of Symbols, Comments and Messages area is used, it is possible to:

- Use local symbols in sub programs: local symbols are then only effective in a sub program. In this case the same string does not conflict with other same strings in other sub-programs
- Extend the maximum character length of symbols (40 instead of 16) and comments (4 sets of 255 characters instead of 1 set of 30)
- Support multi-language: one symbol entry can have up to four comment sets in maximum and the switch of the comment language is synchronized to the general switch of language of the CNC.
- Multi-definition of symbol and comment to one signal
- Data type definition (BOOL, BYTE, WORD, LABEL, PROG, etc.) can be associated to the symbol and comment
- Extension of the character set used in the symbols and comment

## Benefits

- Increase of the capacity to handle messages and symbols
- Simplification of the maintenance tasks with the multi-language comments

## Ordering Information

Specification	Description
A02B-0323-R856#1M	30i-B PMC Symbol, Comment and Message Capacity Expansion (1 MB)
A02B-0323-R856#2M	30i-B PMC Symbol, Comment and Message Capacity Expansion (2 MB)
A02B-0323-R856#512K	30i-B PMC Symbol, Comment and Message Capacity Expansion (512 kB)
A02B-0326-R856#1M	31i-B5 PMC Symbol, Comment and Message Capacity Expansion (1 MB)
A02B-0326-R856#2M	31i-B5 PMC Symbol, Comment and Message Capacity Expansion (2 MB)
A02B-0326-R856#512K	31i-B5 PMC Symbol, Comment and Message Capacity Expansion (512 kB)
A02B-0327-R856#1M	31i-B PMC Symbol, Comment and Message Capacity Expansion (1 MB)
A02B-0327-R856#2M	31i-B PMC Symbol, Comment and Message Capacity Expansion (2 MB)
A02B-0327-R856#512K	31i-B PMC Symbol, Comment and Message Capacity Expansion (512 kB)
A02B-0328-R856#1M	32i-B PMC Symbol, Comment and Message Capacity Expansion (1 MB)
A02B-0328-R856#2M	32i-B PMC Symbol, Comment and Message Capacity Expansion (2 MB)
A02B-0328-R856#512K	32i-B PMC Symbol, Comment and Message Capacity Expansion (512 kB)
A02B-0333-R856#1M	35i-B PMC Symbol, Comment and Message Capacity Expansion (1 MB)
A02B-0333-R856#2M	35i-B PMC Symbol, Comment and Message Capacity Expansion (2 MB)

# 553

Specification	Description
A02B-0333-R856#512K	35i-B PMC Symbol, Comment and Message Capacity Expansion (512 kB)
A02B-0334-R856#1M	PM i-A PMC Symbol, Comment and Message Capacity Expansion (1 MB)
A02B-0334-R856#2M	PM i-A PMC Symbol, Comment and Message Capacity Expansion (2 MB)
A02B-0334-R856#512K	PM i-A PMC Symbol, Comment and Message Capacity Expansion (512 kB)
A02B-0339-R856#1M	0i-TF PMC Symbolic Capacity Expansion: 1 MB
A02B-0339-R856#512K	0i-TF PMC Symbol, Comment and Message Capacity Expansion: 512 kB
A02B-0340-R856#1M	0i-MF PMC Symbolic Capacity Expansion: 1 MB
A02B-0340-R856#512K	0i-MF PMC Symbol, Comment and Message Capacity Expansion: 512 kB

## Notice

Certain functions may require additional hardware, different CPU type or additional memory capacity or may cause compatibility issue with other functions. In case of doubt, contact your FANUC sales representative for additional information and support.

The information given in the FANUC manuals or original manufacturer documentation shall prevail. Technical data is subject to change without prior notice. No part of this document may be reproduced in any form. All rights reserved. © FANUC 2017

# 554

## PMC System

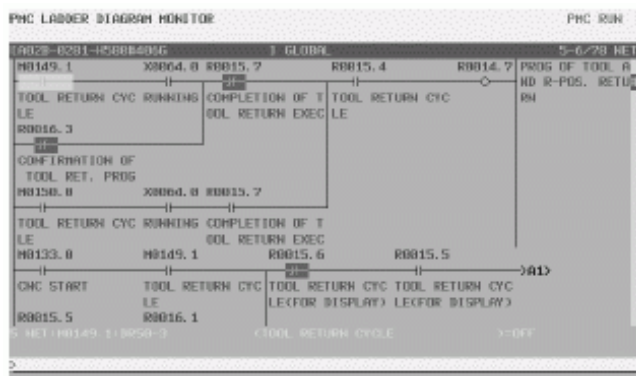

# Step Sequence Function

## Features

The standard PMC programming style on FANUC CNC is the Ladder Programming. This ladder language has been available since many years, and always improved to match the growing demand in complexity.

The ladder method is most often used for programming the sequence control governed by a programmable controller. This method was derived from relay-panel control circuits. Since it has been in use for years, many sequence control engineers are already familiar with it. This method is also used in PMC sequence programming.

A large-scale system requires a large program and a greater number of processes, to control the overall process. In addition optional step sequence method is available for some PMC models, to describe the order/flow of the overall process (see image).

## Step sequence

Step sequence method has been created to describe programs structurally. It is well-suited to the control of entire processes and provides an easy-to-understand visualized flow of the process. The step sequence programming features the direct representation of the control flow on a flow chart. Each block of processing is described as a subprogram, using the ladder method. The entire program is then created by combining these subprograms.

In step sequence programming, a sequence control program is divided into two types of subprograms, steps and transitions. Steps describe processes. Transitions connect steps and determine whether the transition conditions from one step to another evaluate true.

Step Sequence is also called Structure Function Charts (SFC) or Gracet.

### Notice

Certain functions may require additional hardware, different CPU type or additional memory capacity or may cause compatibility issue with other functions. In case of doubt, contact your FANUC sales representative for additional information and support.

The information given in the FANUC manuals or original manufacturer documentation shall prevail. Technical data is subject to change without prior notice. No part of this document may be reproduced in any form. All rights reserved. © FANUC 2017

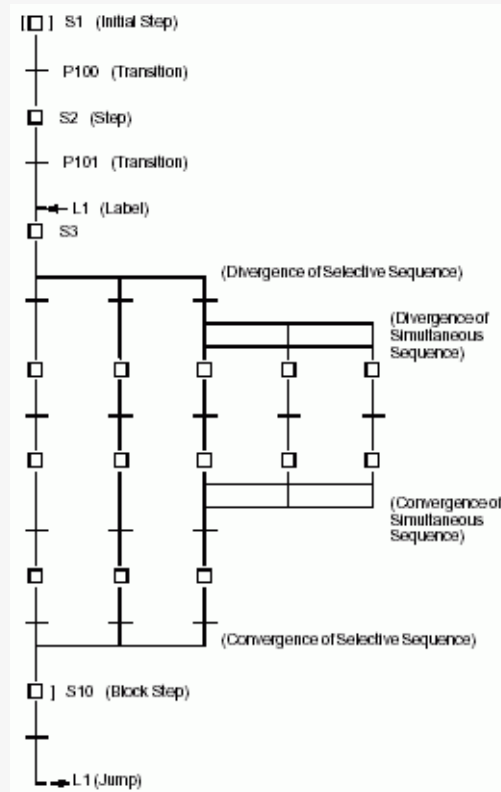

## Ordering Information

Specification	Description
A02B-0323-S982	30i-B Step Sequence Function
A02B-0326-S982	31i-B5 Step Sequence Function
A02B-0327-S982	31i-B Step Sequence Function
A02B-0328-S982	32i-B PMC Step Sequence Function
A02B-0333-S982	35i-B PMC Step Sequence Function
A02B-0334-S982	PM i-A Step Sequence Function
A02B-0339-S982	0i-TF PMC Step Sequence Function
A02B-0340-S982	0i-MF PMC Step Sequence Function

### Notice

Certain functions may require additional hardware, different CPU type or additional memory capacity or may cause compatibility issue with other functions. In case of doubt, contact your FANUC sales representative for additional information and support.

The information given in the FANUC manuals or original manufacturer documentation shall prevail. Technical data is subject to change without prior notice. No part of this document may be reproduced in any form. All rights reserved. © FANUC 2017

# 556

## PMC System

# Non-Volatile PMC Extra Relay Function

## Features

This function increases the number of non-volatile relays available in the PMC to 10 kB

## Benefits

- Increase of the capabilities to handle data to accommodate larger machines

## Ordering Information

Specification	Description
A02B-0323-S984#10K	30i-B PMC Nonvolatile Extra Relay Function, 10 kB
A02B-0326-S984#10K	31i-B5 PMC Nonvolatile Extra Relay Function, 10 kB
A02B-0327-S984#10K	31i-B PMC Nonvolatile Extra Relay Function, 10 kB
A02B-0328-S984#10K	32i-B PMC Nonvolatile Extra Relay Function, 10 kB
A02B-0333-S984#10K	35i-B PMC Nonvolatile Extra Relay Function, 10 kB
A02B-0334-S984#10K	PM i-A PMC Nonvolatile Extra Relay Function, 10 kB
A02B-0339-S984#10K	0i-TF Nonvolatile PMC Extra Relay Function
A02B-0340-S984#10K	0i-MF Nonvolatile PMC Extra Relay Function

### Notice

Certain functions may require additional hardware, different CPU type or additional memory capacity or may cause compatibility issue with other functions. In case of doubt, contact your FANUC sales representative for additional information and support.

The information given in the FANUC manuals or original manufacturer documentation shall prevail. Technical data is subject to change without prior notice. No part of this document may be reproduced in any form. All rights reserved. © FANUC 2017

# 557

## PMC System

# Non-Volatile PMC Data Table Area Expansion (40kB)

## Features

This function increases the number of non-volatile data table available in the PMC to 40 kB

## Benefits

- Increase of the capabilities to handle data to accomodate larger machines

## Ordering Information

Specification	Description
A02B-0323-S967#40K	30i-B PMC Nonvolatile Data Table Expansion, 40 kB
A02B-0326-S967#40K	31i-B5 PMC Nonvolatile Data Table Expansion, 40 kB
A02B-0327-S967#40K	31i-B PMC Nonvolatile Data Table Area Expansion, 40 kB
A02B-0328-S967#40K	32i-B PMC Nonvolatile Data Table Expansion, 40 kB
A02B-0333-S967#40K	35i-B PMC Nonvolatile Data Table Expansion, 40 kB
A02B-0334-S967#40K	PM i-A PMC Nonvolatile Data Table Area Expansion, 40 kB
A02B-0339-S967#40K	0i-TF Nonvolatile PMC Data Table Area Expansion 40 kB
A02B-0340-S967#40K	0i-MF Nonvolatile PMC Data Table Area Expansion 40 kB

### Notice

Certain functions may require additional hardware, different CPU type or additional memory capacity or may cause compatibility issue with other functions. In case of doubt, contact your FANUC sales representative for additional information and support.

The information given in the FANUC manuals or original manufacturer documentation shall prevail. Technical data is subject to change without prior notice. No part of this document may be reproduced in any form. All rights reserved. © FANUC 2017

# 558

## PMC System

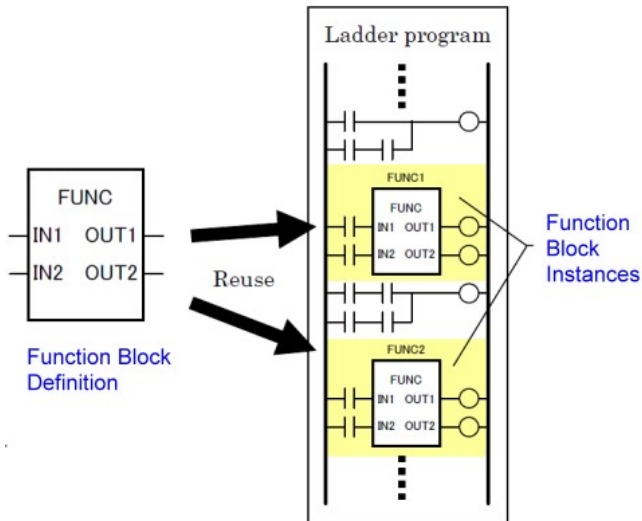

# PMC Function Block Function

## Features

A Function Block (also called FB) is a block of a Ladder Program defined in advance in a library that contains a particular process ( or function).

It is possible to place a defined Function Block in other ladder program and set the required input / output parameters to execute the function.

By defining a frequently used function as a Function Block, it is possible to reuse the function easily thus reducing the time required for programming and increasing the development efficiency.

In addition to the above, program diagnosis can be performed without displaying the detailed program in the function block, which is very efficient to decrease the amount of time required to maintain the machine.

This function is a basic function in FANUC Series 0i-F.

## Benefits

- Reduction of the PMC program development time
- Reduction of the time required to maintain the machine
- Overall improvement of the efficiency and productivity

## Ordering Information

Specification	Description
A02B-0323-R852	30i-B Extended PMC Ladder Instruction Function - PMC Function Blocks
A02B-0326-R852	31i-B5 Extended PMC Ladder Instruction Function - PMC Function Blocks
A02B-0327-R852	31i-B Extended PMC Ladder Instruction Function - PMC Function Blocks
A02B-0328-R852	32i-B Extended PMC Ladder Instruction Function - PMC Function Blocks
A02B-0333-R852	35i-B Extended PMC Ladder Instruction Function - PMC Function Blocks
A02B-0334-R852	PM i-A Extended PMC Ladder Instruction Function - PMC Function Blocks

### Notice

Certain functions may require additional hardware, different CPU type or additional memory capacity or may cause compatibility issue with other functions. In case of doubt, contact your FANUC sales representative for additional information and support.

The information given in the FANUC manuals or original manufacturer documentation shall prevail. Technical data is subject to change without prior notice. No part of this document may be reproduced in any form. All rights reserved. © FANUC 2017

# 559

## Functions

## Machine Safety Functions

---

Machine Safety Functions are features that allow the machine tool builder to construct a machine that is inherently safe for the operator to run. Features such as Dual Check Safety allow the operator to safely setup for machining with the protection door open.

- Chuck and tail stock barrier prevents axis collisions with these machine parts.
- Stored stroke check acts like software over travel limit switches to insure that the machine is not run past the limits of travel.
- Interference check makes sure that multiple paths do not collide with each other.
- Key and Program Encryption prevent programs from being altered by unauthorized personnel.
- Protection of Data at Eight Levels allows different operators to have different authorizations for levels of operations that they are allowed to perform on the machine.

See the Description Manual for a complete list of functions relating to machine safety.

### Notice

Certain functions may require additional hardware, different CPU type or additional memory capacity or may cause compatibility issue with other functions. In case of doubt, contact your FANUC sales representative for additional information and support.

The information given in the FANUC manuals or original manufacturer documentation shall prevail. Technical data is subject to change without prior notice. No part of this document may be reproduced in any form. All rights reserved. © FANUC 2017



# 560

## Machine Safety Functions



### Notice

Certain functions may require additional hardware, different CPU type or additional memory capacity or may cause compatibility issue with other functions. In case of doubt, contact your FANUC sales representative for additional information and support.

The information given in the FANUC manuals or original manufacturer documentation shall prevail. Technical data is subject to change without prior notice. No part of this document may be reproduced in any form. All rights reserved. © FANUC 2017

## Dual Check Safety (DCS)

### Features

The Dual Check Safety (DCS) function provides the necessary set of tools and function to design safe machine tools. A high level of safety to for the machine operator can be reached using this function, especially when the machine tool is open, power is still applied, and the physical security provided by the protective doors is no longer available.

Hardware redundancy and self tests allow the CNC to detect abnormal function and the Dual Check Safety function will quickly shut off power to protect the operator.

Dual Check Safety is certified by TÜV Süd Product Service GmbH in accordance to the following standards:

- 2006/42/EC Machinery Directive
- 2006/95/EC Low-Voltage Directive
- ISO 13849-1 Category 3, PL=d Machine Safety
- EN 60204-1:2006
- EN 61000-6-2:2005
- IEC 61508-1:1998 SIL 1-2
- IEC 61508-2:2000 SIL 1-2
- IEC 61508-3:1998 SIL 1-2
- IEC 61508-4:1998 SIL 1-2
- EN 501 78:1997

Following Dual Check Safety functions have been certified by TÜV SÜD Product Service GmbH:

- Safety Reduced Speed Check (Servo)
- Safety Reduced Speed Check (Spindle)
- Safe End Position Check
- Serial Data Transmission Check
- Emergency Stop
- Safe I/O Signal Check
- Safe Parameter Check
- Safe Servo Position Error Check
- Safe Position Switch Function
- Programmable Safe I/O Function
- Safe Brake Function
- Safe Servo Stop (STO) Function
- Safe Spindle Stop Function
- Safety Speed Zero Monitoring
- Safety Spindle Speed Limit Override (\*)

The functions marked (\*) are not available on the Series Oi-D CNC.

# 561

Special function are also available to simplify the creation of the machine documentation; refer to the "Test Mode Function for Dual Check Safety" in the catalogue for more information.

## Benefits

- Provides a high level of safety for the operator during operations with protection opened while power is still applied
- Quick restart of the machine tool operation following operator intervention
- Fewer external safety circuits required
- Overall cost reduction of the safety solution
- Certified to comply to the actual safety standards

## Ordering Information

Specification	Description
A02B-0323-S661	30i-B Dual Check Safety - ATTENTION: NOT Supporting Analog Spindle, Servos in I/O-Link
A02B-0326-S661	31i-B5 Dual Check Safety - ATTENTION: NOT Supporting Analog Spindle, Servos in I/O-Link
A02B-0327-S661	31i-B Dual Check Safety - ATTENTION: NOT Supporting Analog Spindle, Servos in I/O-Link
A02B-0328-S661	32i-B Dual Check Safety - ATTENTION: NOT Supporting Analog Spindle, Servos in I/O-Link
A02B-0333-S661	35i-B Dual Check Safety - ATTENTION: NOT Supporting Analog Spindle, Servos in I/O-Link
A02B-0334-S661	PM i-A Dual Check Safety - ATTENTION: NOT Supporting Analog Spindle, Servos in I/O-Link
A02B-0339-S661	0i-TF Dual Check Safety
A02B-0340-S661	0i-MF Dual Check Safety

### Notice

Certain functions may require additional hardware, different CPU type or additional memory capacity or may cause compatibility issue with other functions. In case of doubt, contact your FANUC sales representative for additional information and support.

The information given in the FANUC manuals or original manufacturer documentation shall prevail. Technical data is subject to change without prior notice. No part of this document may be reproduced in any form. All rights reserved. © FANUC 2017

# 562

## Machine Safety Functions



## Safety I/O Signal History Function

### Features

The history of state transitions of safety I/O signals is recorded at all times. If an alarm related to Dual Check Safety occurs, the recording is stopped and the recorded signals are displayed. Thereby, the cause of the alarm can be identified easily.

### Benefits

- Reduces downtime

### Ordering Information

Specification	Description
A02B-0333-R667	35i-B Dual Check Safety - Safety I/O Signal History Function
A02B-0334-R667	PM i-A Dual Check Safety - Safety I/O Signal History Function

#### Notice

Certain functions may require additional hardware, different CPU type or additional memory capacity or may cause compatibility issue with other functions. In case of doubt, contact your FANUC sales representative for additional information and support.

The information given in the FANUC manuals or original manufacturer documentation shall prevail. Technical data is subject to change without prior notice. No part of this document may be reproduced in any form. All rights reserved. © FANUC 2017

# 563

## Machine Safety Functions



## Safety Spindle Speed Limit Override

### Features

In the safety speed monitoring function of Dual Check Safety Function, the safety speed for the spindle can be switched between 4 different values / steps by the Safety Speed Selection signal.

When several chucks are used or the safety speed is required to be selected corresponding to the diameter of work, a more detailed selection is required; in this case, the safety speed for the spindle can be overridden from 10% to 100% by the safety spindle speed limit override signal.

### Benefits

- Flexible safe spindle speed management
- Support of complex machine configuration without requiring programming or additional external hardware

### Ordering Information

Specification	Description
A02B-0323-R626	30i-B Dual Check Safety - Safety Spindle Speed Limit Override Function
A02B-0326-R626	31i-B5 Dual Check Safety - Safety Spindle Speed Limit Override Function
A02B-0327-R626	31i-B Dual Check Safety - Safety Spindle Speed Limit Override Function
A02B-0328-R626	32i-B Dual Check Safety - Safety Spindle Speed Limit Override Function
A02B-0333-R626	35i-B Dual Check Safety - Safety Spindle Speed Limit Override Function
A02B-0339-R626	0i-TF Safe Spindle Speed Limit Override Function
A02B-0340-R626	0i-MF Safe Spindle Speed Limit Override Function

#### Notice

Certain functions may require additional hardware, different CPU type or additional memory capacity or may cause compatibility issue with other functions. In case of doubt, contact your FANUC sales representative for additional information and support.

The information given in the FANUC manuals or original manufacturer documentation shall prevail. Technical data is subject to change without prior notice. No part of this document may be reproduced in any form. All rights reserved. © FANUC 2017

# 564

## Machine Safety Functions



# Test Mode Function for Dual Check Safety Acceptance Test

## Features

When designing a machine, a machine builder must document the safety system. A safety confirmation test called "Acceptance Test" must be performed to confirm whether the safety function of a machine works correctly.

During the Acceptance Test, it must be confirmed that an alarm is generated correctly and a machine stops safely, when the machine is placed in not safe condition intentionally.

When the Acceptance Test is performed in a conventional manner, the power of CNC must be turned off and on every time a safety related alarm of Dual Check Safety function is generated and the safety parameter is rewritten. This requires a significant amount of time, especially when the power is turned on and off.

With the Test Mode Function, it is not required to turn the power on and off at each safety alarm generated. In this case, the time required to perform the Acceptance Test is greatly reduced.

Following functions are allowed in an Acceptance Test mode:

- When the safety parameter is changed, the changed parameter is effective without turning the power-off.
- Even if the safety related alarm is generated, the alarm state can be released by the reset operation without turning off and on the power of the CNC

## Benefits

- Faster process of Acceptance Test

## Ordering Information

Specification	Description
A02B-0323-R671	30i-B Dual Check Safety - Test Mode Function for Acceptance Test
A02B-0326-R671	31i-B5 Dual Check Safety - Test Mode Function for Acceptance Test
A02B-0327-R671	31i-B Dual Check Safety - Test Mode Function for Acceptance Test
A02B-0328-R671	32i-B Dual Check Safety - Test Mode Function for Acceptance Test
A02B-0333-R671	35i-B Dual Check Safety - Test Mode Function for Acceptance Test
A02B-0334-R671	PM i-A Dual Check Safety - Test Mode Function for Acceptance Test
A02B-0339-R671	0i-TF Test Mode Function for Acceptance Test
A02B-0340-R671	0i-MF Test Mode Function for Acceptance Test

### Notice

Certain functions may require additional hardware, different CPU type or additional memory capacity or may cause compatibility issue with other functions. In case of doubt, contact your FANUC sales representative for additional information and support.

The information given in the FANUC manuals or original manufacturer documentation shall prevail. Technical data is subject to change without prior notice. No part of this document may be reproduced in any form. All rights reserved. © FANUC 2017

# 565

## Functions

## Option Packages

---

An option package thematically combines various functions in a meaningful way. This section of the catalogue contains information on available option packages.

### Notice

Certain functions may require additional hardware, different CPU type or additional memory capacity or may cause compatibility issue with other functions. In case of doubt, contact your FANUC sales representative for additional information and support.

The information given in the FANUC manuals or original manufacturer documentation shall prevail. Technical data is subject to change without prior notice. No part of this document may be reproduced in any form. All rights reserved. © FANUC 2017

# 566

## Option Packages

# Basic Option

## Features

The Basic Option packages combine functions which are suitable for transfer lines (35i-B) or motion control applications (Power Motion i-A). The following table gives an overview over the functions that are contained in the different Basic Option packages.

Function	35i-B		PMi-A	
	Basic Option 1	Basic Option 2	Basic Option 1	Basic Option 2
Simultaneously Controlled Axes Expansion	-	-	•	•
Axis Control by PMC	•	•	•	•
Controlled Axes Detach	-	•	-	•
Increment System C	-	•	-	•
Inch/Metric Conversion	-	•	-	•
Stroke Limit External Setting	-	•	-	•
Position Switch	-	•	-	•
Reference Point Setting with Mechanical Stopper	-	•	-	•
Manual Handle Feed 1 Unit	•	•	•	•
Handle Interruption	-	•	-	•
Multi-Step Skip	-	•	-	•
3rd/4th Reference Position Return	-	•	-	•
Bell-Shaped Acceleration/Deceleration After Cutting Feed Interpolation	-	•	-	•
Rate Feed	-	•	-	•
Feed Stop	-	•	-	•
Optional Block Skip	-	•	-	•
Custom Macro	•	•	•	•
Addition of Custom Macro Common Variables	•	•	•	•
Pattern Data Input	-	•	-	•
Tool Offset, 99 Pairs	-	•	-	•
Stored Pitch Error Compensation	-	•	-	•
Playback	-	•	-	•
Background Editing	-	•	-	•
Run Hour and Parts Count Display	-	•	-	•
Software Operator's Panel	-	•	-	•
Software Operator's Panel General Purpose Switch	-	•	-	•
Multi-Language Display, Japanese	•	•	•	•
RS232C Interface, 1 Channel	•	•	•	•

### Notice

Certain functions may require additional hardware, different CPU type or additional memory capacity or may cause compatibility issue with other functions. In case of doubt, contact your FANUC sales representative for additional information and support.

The information given in the FANUC manuals or original manufacturer documentation shall prevail. Technical data is subject to change without prior notice. No part of this document may be reproduced in any form. All rights reserved. © FANUC 2017

# 567

Function	35i-B		PMi-A	
	Basic Option 1	Basic Option 2	Basic Option 1	Basic Option 2
RS232C Interface, 2 Channels	-	•	-	•
External Data Input	-	•	-	•
External I/O Device Control	-	•	-	•

## Benefits

- Select the options for transfer lines or motion control applications easily

## Ordering Information

Specification	Description
A02B-0333-R702	35i-B Basic Option 1 - Incl. Axis Control by PMC, Manual Handle Feed 1 Unit, Custom Macro, Addition of Custom Macro Common Variables, RS232C Interface 1, Japanese Language Display
A02B-0333-R703	35i-B Basic Option 2 - Incl. Basic Option 1, Axes Detach, Incr. System C, Inch/Metric Conv., Stroke Limit Ext. Setting, Pos. Switch, Ref.-Point Setting w. Mech. Stopper, Handle Interruption, Synchr. Cutting, Multi-Step Skip, 3rd/4th Ref. Pos. Return, Bell-shaped Acc./Dec. after Cutting Feed Interp., Pitch Error Comp., Ext. Data Input, Tool Offset 99 Pairs, Run Hour / Parts Count Display, SW Operator's Panel / Gen. Purpose Switch, Playback, Multi-Part Progr. Edit, RS232C I/F 2, Ext. Contr. of I/O Device, Pattern Data Input, Rate Feed, Feed Stop
A02B-0334-R702	PM i-A Basic Option 1 - Incl. 4 Simult. Controlled Axes, Axis Control by PMC, Manual Handle Feed 1 Unit, Custom Macro, Addition of Custom Macro Common Variables, RS232C Interface 1, Japanese Language Display
A02B-0334-R703	PM i-A Basic Option 2 - Incl. Basic Option 1, Axes Detach, Incr. System C, Inch/Metric Conv., Stroke Limit Ext. Setting, Pos. Switch, Ref.-Point Setting w. Mech. Stopper, Handle Interruption, Synchr. Cutting, Multi-Step Skip, 3rd/4th Ref. Pos. R

### Notice

Certain functions may require additional hardware, different CPU type or additional memory capacity or may cause compatibility issue with other functions. In case of doubt, contact your FANUC sales representative for additional information and support.

The information given in the FANUC manuals or original manufacturer documentation shall prevail. Technical data is subject to change without prior notice. No part of this document may be reproduced in any form. All rights reserved. © FANUC 2017



# 568

## Option Packages

# Milling Standard Package

## Features

Milling Standard Package is a series of option packages for the FANUC Series 30i-B/31i-B5/31i-B that contains the relevant options suitable for high-speed and high-quality machining. The following table lists the options which are combined in the different packages.

Function	Milling Standard Package		
	I+	II+	III+
Controllable Axes Expansion	•	•	•
Simultaneously Controlled Axes Expansion	•	•	•
Increment System C	•	•	•
Run Hour and Parts Count Display	•	•	•
Bell-Shaped Acceleration/Deceleration After Cutting Feed Interpolation	•	•	•
HRV3 Control	•	•	•
Manual Handle Feed 1 Unit	•	•	•
Workpiece Coordinate System	•	•	•
Workpiece Coordinate System Preset	•	•	•
Tool Radius / Tool Nose Radius Compensation	•	•	•
Tool Offset Memory C	•	•	•
Inch/Metric Conversion	•	•	•
Custom Macro	•	•	•
Addition of Custom Macro Common Variables	•	•	•
Canned Cycles for Drilling	•	•	•
Rigid Tapping	•	•	•
Retraction for Rigid Tapping	•	•	•
Rigid Tapping with Bell-Shaped Acceleration/Deceleration	•	•	•
Background Editing	•	•	•
Spindle Serial Output	•	•	•
Spindle Orientation	•	•	•
Unexpected Disturbance Torque Detection function	•	•	•
Quick Program Restart	•	•	•
High-Speed Skip	•	•	•
Stored Pitch Error Compensation	•	•	•
Interpolation Type Pitch Error Compensation	•	•	•
Straightness Compensation	•	•	•
Interpolation Type Straightness Compensation	•	•	•
AI Contour Control II	•	•	•
Smooth Tolerance Control	•	•	•

### Notice

Certain functions may require additional hardware, different CPU type or additional memory capacity or may cause compatibility issue with other functions. In case of doubt, contact your FANUC sales representative for additional information and support.

The information given in the FANUC manuals or original manufacturer documentation shall prevail. Technical data is subject to change without prior notice. No part of this document may be reproduced in any form. All rights reserved. © FANUC 2017

# 569

Function	Milling Standard Package		
	I+	II+	III+
High-Speed Processing	•	•	•
3-Dimensional Manual Feed	-	•	•
Tilted Working Plane Command	-	•	•
Retraction for 3-Dimensional Rigid Tapping	-	•	•
Workpiece Setting Error Compensation	-	•	•
3-Dimensional Rotary Error Compensation	-	•	•
High-Speed Smooth TCP	-	-	•
3-Dimensional Cutter Compensation	-	-	•

## Benefits

- Select the necessary options for high-speed and high-quality machining easily

## Ordering Information

Specification	Description
A02B-0323-R370	30i-B Milling Standard Package I+
A02B-0323-R371	30i-B Milling Standard Package II+
A02B-0323-R372	30i-B Milling Standard Package III+
A02B-0326-R370	31i-B5 Milling Standard Package I+
A02B-0326-R371	31i-B5 Milling Standard Package II+
A02B-0326-R372	31i-B5 Milling Standard Package III+
A02B-0327-R370	31i-B Milling Standard Package I+
A02B-0327-R371	31i-B Milling Standard Package II+
A02B-0327-R372	31i-B Milling Standard Package III+

### Notice

Certain functions may require additional hardware, different CPU type or additional memory capacity or may cause compatibility issue with other functions. In case of doubt, contact your FANUC sales representative for additional information and support.

The information given in the FANUC manuals or original manufacturer documentation shall prevail. Technical data is subject to change without prior notice. No part of this document may be reproduced in any form. All rights reserved. © FANUC 2017

# 570 CNC

## Communication

This section of the catalogue contains an overview of the most popular communication function available on the FANUC CNC.

The communication functions described include:

- FANUC Ethernet protocols
- EtherNet/IP
- PROFIBUS-DP
- PROFINET
- Etc.



### Notice

Certain functions may require additional hardware, different CPU type or additional memory capacity or may cause compatibility issue with other functions. In case of doubt, contact your FANUC sales representative for additional information and support.

The information given in the FANUC manuals or original manufacturer documentation shall prevail. Technical data is subject to change without prior notice. No part of this document may be reproduced in any form. All rights reserved. © FANUC 2017

# 571

## Communication



### Notice

Certain functions may require additional hardware, different CPU type or additional memory capacity or may cause compatibility issue with other functions. In case of doubt, contact your FANUC sales representative for additional information and support.

The information given in the FANUC manuals or original manufacturer documentation shall prevail. Technical data is subject to change without prior notice. No part of this document may be reproduced in any form. All rights reserved. © FANUC 2017

## Embedded Ethernet

### Features

The Series 30i CNC family as well as the Power Motion i CNC are equipped with an embedded Ethernet port (Ethernet connection on the mother board). This port can support several connection types and protocols to simplify the connection of the CNC to the outside world and greatly improve its efficiency.

The following functions and protocols are supported by the embedded Ethernet port:

- DHCP
- DNS
- DNC1 over Ethernet
- FTP client
- FOCAS / FOCAS 2
- Basic Operation Package 2
- FANUC Ladder
- Modbus/TCP Server\*

Note: \*Modbus/TCP function required. See further in the communication section of the catalogue for more information about the Modbus/TCP function.

In addition to the embedded Ethernet port, it is possible to increase the number of Ethernet ports of the CNC by adding separate Ethernet boards in the option slots of the CNC (Standalone or LCD-Mounted types) or using a Multi-Function Ethernet module (LCD-Mounted type CNC only). The additional Ethernet boards and modules have their own processors and provide more processing power for complex protocols or multiple and concurrent Ethernet connections.

### Benefits

- Addition of Ethernet connectivity to the CNC
- Increase of the maintenance and remote access efficiency
- Provides data collection capabilities to the CNC
- Improvement of machine flexibility and increase of the system efficiency / productivity

### Ordering Information

Specification	Description
A02B-0323-J571#658M	30i/31i/32i-B Embedded Ethernet - Control Software
A02B-0323-R975	30i-B CNC Status Notification Function (Email to e.g. PC via Embedded Ethernet)
A02B-0326-R975	31i-B5 CNC Status Notification Function (Email to e.g. PC via Embedded Ethernet)
A02B-0327-R975	31i-B CNC Status Notification Function (Email to e.g. PC via Embedded Ethernet)
A02B-0328-R975	32i-B CNC Status Notification Function (Email to e.g. PC via Embedded Ethernet)

# 572

Specification	Description
A02B-0333-J571#658M	35i-B Embedded Ethernet - Control Software
A02B-0333-R975	35i-B CNC Status Notification Function (Email to e.g. PC via Embedded Ethernet)
A02B-0334-J571#658M	PM i-A Embedded Ethernet - Control Software
A02B-0334-R975	PM i-A CNC Status Notification Function (Email to e.g. PC via Embedded Ethernet)
A02B-0339-J571#658A	0i-F Embedded Ethernet Software
A02B-0339-R975	0i-TF CNC Status Notification Function
A02B-0340-R975	0i-MF CNC Status Notification Function

## Notice

Certain functions may require additional hardware, different CPU type or additional memory capacity or may cause compatibility issue with other functions. In case of doubt, contact your FANUC sales representative for additional information and support.

The information given in the FANUC manuals or original manufacturer documentation shall prevail. Technical data is subject to change without prior notice. No part of this document may be reproduced in any form. All rights reserved. © FANUC 2017

# 573

## Communication

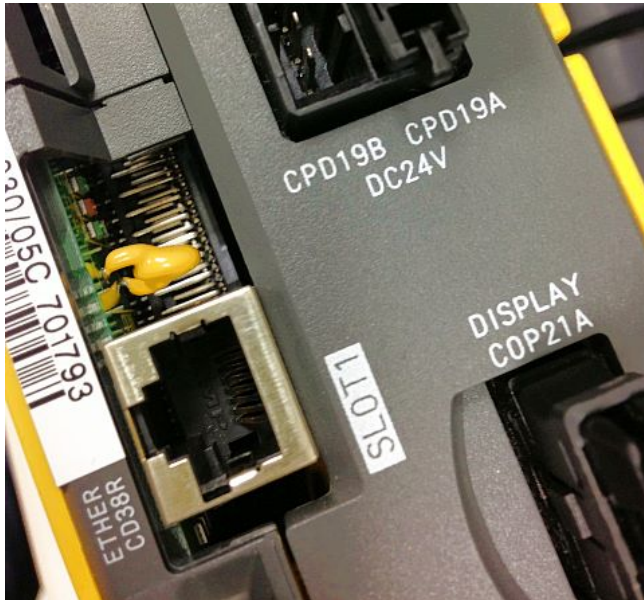

## Fast Ethernet

### Features

The Fast Ethernet board and functions bring the possibility to install additional Ethernet connections to the CNC. The Fast Ethernet board features its own processors so that more processing power is available to manage the communication and protocols.

Up to 3 Fast Ethernet boards can be installed in a Series 30i/31i/32i 4-slots standalone controllers. Up to 2 Fast Ethernet boards can be installed in a LCD-mounted CNC or in a Series 35i and Power Motion i-A standalone controllers.

Together with the embedded Ethernet port, the Fast Ethernet boards and/or the Multi-Function Ethernet Module, up to 4 separate Ethernet connections can be realized.

The Fast Ethernet board can run concurrent protocols and services such as:

- DHCP
- DNS
- DNC1 over Ethernet
- FTP client
- Screen Display Function
- Data Server and Fast Data Server
- FOCAS / FOCAS 2
- Basic Operation Package 2
- Remote Diagnostics
- FANUC Ladder
- FANUC SERVO GUIDE

It can support popular networking protocols such as:

- EtherNet/IP Scanner
- EtherNet/IP Scanner Adapter
- PROFINET I/O Device
- FL-net
- Modbus/TCP

Note:

- Refer to the connection manual for additional information on the protocols, settings and eventual limitations related to the concurrent use of different protocols in the Fast Ethernet board.

### Benefits

- Addition of Ethernet connectivity to the CNC

#### Notice

Certain functions may require additional hardware, different CPU type or additional memory capacity or may cause compatibility issue with other functions. In case of doubt, contact your FANUC sales representative for additional information and support.

The information given in the FANUC manuals or original manufacturer documentation shall prevail. Technical data is subject to change without prior notice. No part of this document may be reproduced in any form. All rights reserved. © FANUC 2017

- Improvement of the Ethernet connectivity of the CNC with many popular protocols
- Increase of the maintenance and remote access efficiency
- Provides data collection capabilities to the CNC
- Improvement of machine flexibility and increase of the system efficiency / productivity

## Ordering Information

Specification	Description
A02B-0323-J147	30i/31i/32i/35i-B, PM i-A Fast Ethernet Board
A02B-0323-J561#658K	30i/31i/32i-B Fast Ethernet - Control Software
A02B-0323-S707	30i-B Ethernet Function
A02B-0326-S707	31i-B5 Ethernet Function
A02B-0327-S707	31i-B Ethernet Function
A02B-0328-S707	32i-B Ethernet Function
A02B-0333-J561#658K	35i-B Fast Ethernet - Control Software
A02B-0333-S707	35i-B Ethernet Function
A02B-0334-J561#658K	PM i-A Fast Ethernet - Control Software
A02B-0334-S707	PM i-A Ethernet Function
A02B-0338-J147	0i-F Fast Ethernet Board (100BASE-TX)
A02B-0339-S707	0i-TF Ethernet Function
A02B-0340-S707	0i-MF Ethernet Function

### Notice

Certain functions may require additional hardware, different CPU type or additional memory capacity or may cause compatibility issue with other functions. In case of doubt, contact your FANUC sales representative for additional information and support.

The information given in the FANUC manuals or original manufacturer documentation shall prevail. Technical data is subject to change without prior notice. No part of this document may be reproduced in any form. All rights reserved. © FANUC 2017

# 575

## Communication



Master

# PROFIBUS-DP Master

## Features

The PROFIBUS-DP Master function and the PROFIBUS-DP Master board for the CNC provide an easy way to setup the CNC system to connect to popular PLCs and I/O devices equipment using PROFIBUS-DP.

Up to 48 PROFIBUS-DP Slave stations can be connected to the Master with a total of 244 bytes per Slave station.

PROFIBUS-DP is available for the Series 30i/31i/32i-A CNC, the Series 30i/31i/32i/35i-B CNC, the Power Motion i-A and the Series 0i-D CNC. It is also available on numerous FANUC legacy CNC systems.

Notes:

- The PROFIBUS-DP functions cannot be used simultaneously with the DeviceNet functions or CC-Link functions
- Refer to the connection manual for additional information on the PROFIBUS-DP functions supported, the size of the data tables, settings, diagnostics and GSD files

## Benefits

- Connection to PLCs and equipment by PROFIBUS-DP network
- Acceleration of the system installation and commissioning
- Improvement of machine flexibility and increase of the system efficiency / productivity

## Ordering Information

Specification	Description
A02B-0323-J311	30i/31i/32i/35i-B, PM i-A Profibus DP Master Board
A02B-0323-J535#655B	30i/31i/32i-B Profibus DP - Application Software
A02B-0323-J562#6552	30i/31i/32i-B Profibus DP Master - Control Software
A02B-0323-S731	30i-B Profibus DP Master Function
A02B-0326-S731	31i-B5 Profibus DP Master Function
A02B-0327-S731	31i-B Profibus DP Master Function
A02B-0328-S731	32i-B Profibus DP Master Function
A02B-0333-J535#655B	35i-B Profibus DP - Application Software
A02B-0333-J562#6552	35i-B Profibus DP Master - Control Software
A02B-0333-S731	35i-B Profibus DP Master Function
A02B-0334-J535#655B	PM i-A Profibus DP - Application Software
A02B-0334-J562#6552	PM i-A Profibus DP Master - Control Software
A02B-0334-S731	PM i-A Profibus DP Master Function
A02B-0338-J311	0i-F Profibus DP Master Board

### Notice

Certain functions may require additional hardware, different CPU type or additional memory capacity or may cause compatibility issue with other functions. In case of doubt, contact your FANUC sales representative for additional information and support.

The information given in the FANUC manuals or original manufacturer documentation shall prevail. Technical data is subject to change without prior notice. No part of this document may be reproduced in any form. All rights reserved. © FANUC 2017



# 576

Specification	Description
A02B-0339-S731	0i-TF Profibus Master Function
A02B-0340-S731	0i-MF Profibus Master Function

## Notice

Certain functions may require additional hardware, different CPU type or additional memory capacity or may cause compatibility issue with other functions. In case of doubt, contact your FANUC sales representative for additional information and support.

The information given in the FANUC manuals or original manufacturer documentation shall prevail. Technical data is subject to change without prior notice. No part of this document may be reproduced in any form. All rights reserved. © FANUC 2017

# 577

## Communication



# PROFIBUS-DP Slave

## Features

The PROFIBUS-DP Slave function and the PROFIBUS-DP Slave board for the CNC provide an easy way to setup the CNC system to connect to popular PLCs and I/O devices equipment using PROFIBUS-DP.

The PROFIBUS-DP Slave function provides up to 244 bytes of data to the PROFIBUS-DP Master device.

PROFIBUS-DP is available for the Series 30i/31i/32i-A CNC, the Series 30i/31i/32i/35i-B CNC, the Power Motion i-A and the Series 0i-D CNC. It is also available on numerous FANUC legacy CNC systems.

Notes:

- The PROFIBUS-DP functions cannot be used simultaneously with the DeviceNet functions or CC-Link functions
- Refer to the connection manual for additional information on the PROFIBUS-DP functions supported, the size of the data tables, settings, diagnostics and GSD files

## Benefits

- Connection to PLCs and equipment by PROFIBUS-DP network
- Acceleration of the system installation and commissioning
- Improvement of machine flexibility and increase of the system efficiency / productivity

## Ordering Information

Specification	Description
A02B-0323-J313	30i/31i/32i/35i-B, PM i-A Profibus DP Slave Board
A02B-0323-J535#655B	30i/31i/32i-B Profibus DP - Application Software
A02B-0323-J563#655C	30i/31i/32i-B Profibus DP Slave - Control Software
A02B-0323-S732	30i-B Profibus DP Slave Function
A02B-0326-S732	31i-B5 Profibus DP Slave Function
A02B-0327-S732	31i-B Profibus DP Slave Function
A02B-0328-S732	32i-B Profibus DP Slave Function
A02B-0333-J535#655B	35i-B Profibus DP - Application Software
A02B-0333-J563#655C	35i-B Profibus DP Slave - Control Software
A02B-0333-S732	35i-B Profibus DP Slave Function
A02B-0334-J535#655B	PM i-A Profibus DP - Application Software
A02B-0334-J563#655C	PM i-A Profibus DP Slave - Control Software
A02B-0334-S732	PM i-A Profibus DP Slave Function
A02B-0338-J313	0i-F Profibus DP Slave Board

### Notice

Certain functions may require additional hardware, different CPU type or additional memory capacity or may cause compatibility issue with other functions. In case of doubt, contact your FANUC sales representative for additional information and support.

The information given in the FANUC manuals or original manufacturer documentation shall prevail. Technical data is subject to change without prior notice. No part of this document may be reproduced in any form. All rights reserved. © FANUC 2017

# 578

Specification	Description
A02B-0339-S732	0i-TF Profibus Slave Function
A02B-0340-S732	0i-MF Profibus Slave Function

**Notice**

Certain functions may require additional hardware, different CPU type or additional memory capacity or may cause compatibility issue with other functions. In case of doubt, contact your FANUC sales representative for additional information and support.

The information given in the FANUC manuals or original manufacturer documentation shall prevail. Technical data is subject to change without prior notice. No part of this document may be reproduced in any form. All rights reserved. © FANUC 2017

# 579

## Communication



# DeviceNet Scanner (Master)

## Features

DeviceNet is one of the world's leading device-level networks for industrial automation. DeviceNet offers robust, efficient data handling because it is based on Producer/Consumer technology. This modern communications model offers key capabilities that allow the user to determine effectively what information is needed and when.

The specification of DeviceNet is managed by ODVA (Open DeviceNet Vendor Association).

The DeviceNet Scanner (Master) function and the DeviceNet Scanner board provide an easy way to setup the installation and the connection of the CNC to popular PLCs and I/O devices using DeviceNet.

Specifications:

- Up to 63 slaves can be addressed
- Up to 128 byte of digital inputs and 128 bytes of digital output per slave (maximum 320 bytes of digital inputs and 320 bytes of digital outputs for the whole network)
- Supports poll I/O connection and bit strobe I/O connection
- MAC ID can be selected between 0 to 63

## Benefits

- Connect to PLCs and machines by DeviceNet network
- Acceleration of the system installation and commissioning
- Improvement of machine flexibility and increase of the system efficiency / productivity

## Ordering Information

Specification	Description
A02B-0323-J301	30i/31i/32i/35i-B, PM i-A DeviceNet Master Board
A02B-0323-J303	30i/31i/32i-B DeviceNet Master Board (Card Slot on Main Board A2 or A5)
A02B-0323-J565#6579	30i/31i/32i-B DeviceNet - Control Software
A02B-0323-S723	30i-B DeviceNet Master Function
A02B-0326-S723	31i-B5 DeviceNet Master Function
A02B-0327-S723	31i-B DeviceNet Master Function
A02B-0328-S723	32i-B DeviceNet Master Function
A02B-0333-J565#6579	35i-B DeviceNet - Control Software
A02B-0333-S723	35i-B DeviceNet Master Function
A02B-0334-J565#6579	PM i-A DeviceNet - Control Software
A02B-0334-S723	PM i-A DeviceNet Master Function

### Notice

Certain functions may require additional hardware, different CPU type or additional memory capacity or may cause compatibility issue with other functions. In case of doubt, contact your FANUC sales representative for additional information and support.

The information given in the FANUC manuals or original manufacturer documentation shall prevail. Technical data is subject to change without prior notice. No part of this document may be reproduced in any form. All rights reserved. © FANUC 2017

# 580

Specification	Description
A02B-0338-J301	0i-F DeviceNet Master Board
A02B-0339-S723	0i-TF DeviceNet Master Function
A02B-0340-S723	0i-MF DeviceNet Master Function

## Notice

Certain functions may require additional hardware, different CPU type or additional memory capacity or may cause compatibility issue with other functions. In case of doubt, contact your FANUC sales representative for additional information and support.

The information given in the FANUC manuals or original manufacturer documentation shall prevail. Technical data is subject to change without prior notice. No part of this document may be reproduced in any form. All rights reserved. © FANUC 2017

# 581

## Communication



## DeviceNet Adapter (Slave)

### Features

DeviceNet is one of the world's leading device-level networks for industrial automation. DeviceNet offers robust, efficient data handling because it is based on Producer/Consumer technology. This modern communications model offers key capabilities that allow the user to determine effectively what information is needed and when.

The specification of DeviceNet is managed by ODVA (Open DeviceNet Vendor Association).

The DeviceNet Adapter (Slave) function and the DeviceNet Adapter board provide an easy way to setup the installation and the connection of the CNC to popular PLCs and I/O devices using DeviceNet.

Specifications:

- Up to 128 byte of digital inputs and 128 bytes of digital output per slave
- Supports poll I/O connection and bit strobe I/O connection
- MAC ID can be selected between 0 to 63

### Benefits

- Connect to PLCs and machines by DeviceNet network
- Acceleration of the system installation and commissioning
- Improvement of machine flexibility and increase of the system efficiency / productivity

### Ordering Information

Specification	Description
A02B-0323-J302	30i/31i/32i/35i-B, PM i-A DeviceNet Slave Board
A02B-0323-J565#6579	30i/31i/32i-B DeviceNet - Control Software
A02B-0323-S724	30i-B DeviceNet Slave Function
A02B-0326-S724	31i-B5 DeviceNet Slave Function
A02B-0327-S724	31i-B DeviceNet Slave Function
A02B-0328-S724	32i-B DeviceNet Slave Function
A02B-0333-J565#6579	35i-B DeviceNet - Control Software
A02B-0333-S724	35i-B DeviceNet Slave Function
A02B-0334-J565#6579	PM i-A DeviceNet - Control Software
A02B-0334-S724	PM i-A DeviceNet Slave Function
A02B-0338-J302	0i-F DeviceNet Slave Board
A02B-0339-S724	0i-TF DeviceNet Slave Function
A02B-0340-S724	0i-MF DeviceNet Slave Function

#### Notice

Certain functions may require additional hardware, different CPU type or additional memory capacity or may cause compatibility issue with other functions. In case of doubt, contact your FANUC sales representative for additional information and support.

The information given in the FANUC manuals or original manufacturer documentation shall prevail. Technical data is subject to change without prior notice. No part of this document may be reproduced in any form. All rights reserved. © FANUC 2017

# 582

## Communication

# High Speed Serial Bus (HSSB)

## Features

The FANUC HSSB (High Speed Serial Bus) is a FANUC proprietary communication protocol and hardware designed for point to point communication. It can be used to communicate between a CNC and a Panel i or between a CNC and a Personal Computer. The bus is mainly used within the "Open CNC" concept of FANUC.

The HSSB communication uses Fiber Optics cables as transmission media; it is therefore very robust and noise immune.

FANUC provides optional boards for certain CNC models and PCI cards for Personal Computers. The Panel i PC display units and recent FANUC CNC feature on-board HSSB ports.

Note:

- The PORT 2 function provides the capability to operate the same function on different hardware boards at the same time. Example: if the HSSB function and the HSSB PORT 2 function are specified, the HSSB function can be operated on different hardware boards at the same time.

Related functions:

- FOCAS / FOCAS 2
- Basic Operation Package 2
- Ladder Editing Package
- DNC Management Package
- CNC Screen Display Function

## Benefits

- Simple, robust and noise immune connection between CNC and Personal Computers or Panel i
- Simplification of the integration of an "Open CNC" concept
- Improvement of machine flexibility and increase of the system efficiency / productivity

## Ordering Information

Specification	Description
A02B-0207-J900	30i/31i/32i-A, 30i/31i/32i/35i-B, PM i-A Extended Drivers and Libraries
A02B-0323-J202	30i/31i/32i-B - CNC Side HSSB Interface Board A
A02B-0323-S749	30i-B FOCAS2 / HSSB Port 2 Function
A02B-0326-S749	31i-B5 FOCAS2 / HSSB Port 2 Function
A02B-0327-S749	31i-B FOCAS2 / HSSB Port 2 Function
A02B-0328-S749	32i-B FOCAS2 / HSSB Port 2 Function

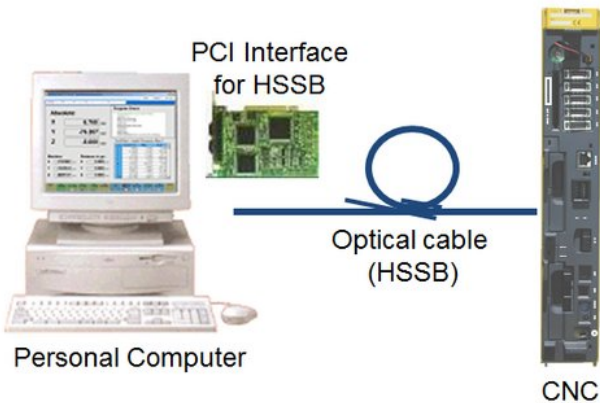
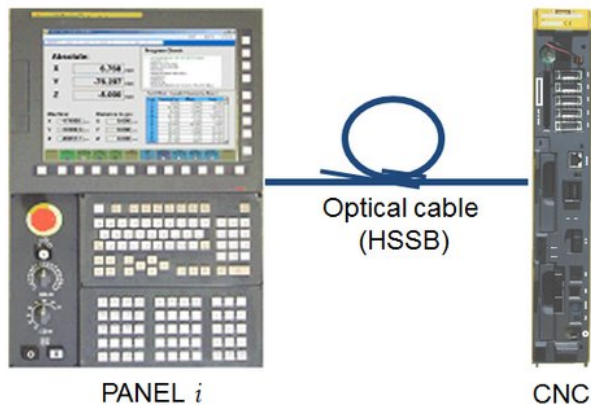

### Notice

Certain functions may require additional hardware, different CPU type or additional memory capacity or may cause compatibility issue with other functions. In case of doubt, contact your FANUC sales representative for additional information and support.

The information given in the FANUC manuals or original manufacturer documentation shall prevail. Technical data is subject to change without prior notice. No part of this document may be reproduced in any form. All rights reserved. © FANUC 2017

# 583

Specification	Description
A02B-0338-J202	0i-F CNC Side HSSB Interface Board A
A02B-0339-S749	0i-TF FOCAS2 / HSSB Port 2 Function
A02B-0340-S749	0i-MF FOCAS2 / HSSB Port 2 Function
A13B-0204-C001	30i/31i/32i-A/B, 35i-B, PM i-A, 0i-D - PC Side HSSB Interface Board, PCI Express, 1 Channel, Low Profile
A13B-0204-C002	30i/31i/32i-A/B, 35i-B, PM i-A, 0i-D - PC Side HSSB Interface Board, PCI Express, 1 Channel, Standard Height
A20B-8101-0162	30i/31i/32i / 0i-D - PC Side HSSB Interface Board, PCI Bus, 2 Channels
A20B-8101-0163	30i/31i/32i / 0i-D - PC Side HSSB Interface Board, PCI Bus, 1 Channel

## Notice

Certain functions may require additional hardware, different CPU type or additional memory capacity or may cause compatibility issue with other functions. In case of doubt, contact your FANUC sales representative for additional information and support.

The information given in the FANUC manuals or original manufacturer documentation shall prevail. Technical data is subject to change without prior notice. No part of this document may be reproduced in any form. All rights reserved. © FANUC 2017



# 584

## Communication



## FL-net

### Features

The FL-net network on Ethernet is also known as JEMA Open PLC network - 2 (OPCN-2). The FL-net interface board and function provide an easy way to setup the system installation and the connection to popular PLCs and equipment using FL-net.

FL-net can interconnect various types of controllers such as programmable controllers (PLC), robots, CNC and personal computers of many different manufacturers to control and monitor them.

Function highlights:

- Multi-vendor environment using an open network: FL-net conforms to open standards so that communication devices manufactured by different vendors /manufacturers can communicate with each other.
- Large-scale network: up to 249 communication devices (nodes) can be connected to share data.
- Two communication functions are available: FL-net supports both the common memory and message communication. The common memory communication uses cyclic data transmission to allow the nodes to always share the same data. The message communication allows the nodes to exchange only required information on demand.
- Large-capacity common memory: 8K bits + 8K words (a total of 17K bytes) of large-capacity common memory can be shared among all nodes.
- Fast response: FL-net provides a fast response of 50 ms/32 nodes (at 2K bits + 2K words/32 nodes).
- High reliability: each node can participate in or be disconnected from the FL-net at any time. In this case, the power to each node can be turned on or off without problem and can provide high maintainability. The masterless token method allows communication to be continued without stopping the network by the token management, if a failure occurs in a communication device.
- Low cost: the use of cables for Ethernet can reduce the cost of communication devices such as transceivers and hubs as well as on cabling.
- High maintainability: various types of management tables are available. The management tables can be referenced to identify a faulty node quickly.
- Additional FANUC enhancements to FL-net: increase of the transmission speed from 10Mbps to 100Mbps, simultaneous FL-net and Ethernet communication on the same network (CNC Screen Display, File Transfer, FANUC LADDER-III, etc.)

Notes:

- The Ethernet hardware of the CNC supports several concurrent protocols and connections. Refer to the connection manuals for details and limitations that may exist.
- The PORT 2 function provides the capability to operate the same function on different hardware boards at the same time. Example: if the FL-net function and the FL-net PORT 2 functions are specified, the FL-net function can be operated on different hardware boards at the same time.
- FL-net supports safety functions. Refer to the "FL-net safety" section further in this catalogue for more information.

#### Notice

Certain functions may require additional hardware, different CPU type or additional memory capacity or may cause compatibility issue with other functions. In case of doubt, contact your FANUC sales representative for additional information and support.

The information given in the FANUC manuals or original manufacturer documentation shall prevail. Technical data is subject to change without prior notice. No part of this document may be reproduced in any form. All rights reserved. © FANUC 2017

## Benefits

- Easy connection to Robots, PLCs and equipment using FL-net network
- Acceleration of the system installation and commissioning
- Improvement of machine flexibility and increase of the system efficiency / productivity

## Ordering Information

Specification	Description
A02B-0323-J147	30i/31i/32i/35i-B, PM i-A Fast Ethernet Board
A02B-0323-J561#658K	30i/31i/32i-B Fast Ethernet - Control Software
A02B-0323-J692	30i-B FL-Net Function
A02B-0323-R964	30i-B FL-Net Port 2 Function
A02B-0326-J692	31i-B5 FL-Net Function
A02B-0326-R964	31i-B5 FL-Net Port 2 Function
A02B-0327-J692	31i-B FL-Net Function
A02B-0327-R964	31i-B FL-Net Port 2 Function
A02B-0328-J692	32i-B FL-Net Function
A02B-0328-R964	32i-B FL-Net Port 2 Function
A02B-0333-J561#658K	35i-B Fast Ethernet - Control Software
A02B-0333-J692	35i-B FL-Net Function
A02B-0333-R964	35i-B FL-Net Port 2 Function
A02B-0334-J561#658K	PM i-A Fast Ethernet - Control Software
A02B-0334-J692	PM i-A FL-Net Function
A02B-0334-R964	PM i-A FL-Net Port 2 Function
A02B-0339-J692	0i-TF FL-Net Function
A02B-0340-J692	0i-MF FL-Net Function

### Notice

Certain functions may require additional hardware, different CPU type or additional memory capacity or may cause compatibility issue with other functions. In case of doubt, contact your FANUC sales representative for additional information and support.

The information given in the FANUC manuals or original manufacturer documentation shall prevail. Technical data is subject to change without prior notice. No part of this document may be reproduced in any form. All rights reserved. © FANUC 2017

# 586

## Communication

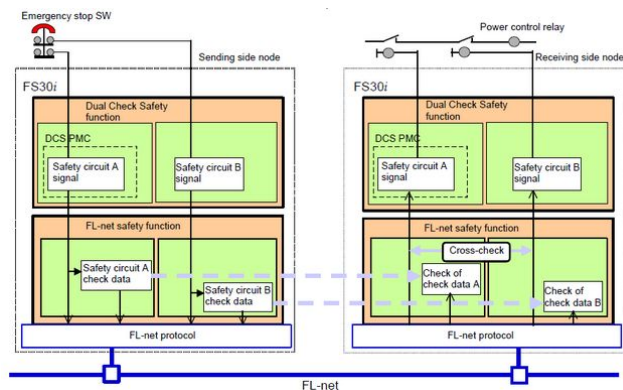

### Notice

Certain functions may require additional hardware, different CPU type or additional memory capacity or may cause compatibility issue with other functions. In case of doubt, contact your FANUC sales representative for additional information and support.

The information given in the FANUC manuals or original manufacturer documentation shall prevail. Technical data is subject to change without prior notice. No part of this document may be reproduced in any form. All rights reserved. © FANUC 2017

# FL-net Safety

## Features

In a machining system such as a transfer machine or a networked manufacturing cells, stations are each equipped with an operator's panel having an emergency stop button or other safety related signals.

Traditionally, it is necessary to implement a separate hardwired safety circuit for the entire system so that, when the emergency stop button at any station is pressed, the emergency stop signal can be transferred to all CNCs.

When using the Safety function on FL-net, the transmission of safety-related signals connected to safety circuits to multiple CNCs connected via FL-net is provided on a single network. In this case, the system cabling is simplified, the setup and commissioning is accelerated and the total cost of the system is reduced.

The Safety function of FL-net is an additional function of the Dual Check Safety function of the CNC. It operates on two CPUs as the Dual Check Safety function does. Refer to "Dual Check Safety" section of the catalogue for further details on the safety functions of the CNC.

Basic elements of the Safety function by FL-net are redundant nodes on the sending side and the receiving side. A safe circuit for the line is implemented by the combination of these nodes. The sending node adds proofing data to each of the redundant signals of the safety circuit and sends these signals safely. The receiving node checks the proofing data and cross-checks the received signal data to ensure that there is no error in the FL-net communication.

## Benefits

- Simplified connection of Robots, CNC and PLCs with Safety Function transmitted over the FL-net network
- Simplification of the architectures
- Acceleration of the system installation and commissioning
- Improvement of machine flexibility and increase of the system efficiency / productivity

## Ordering Information

Specification	Description
A02B-0323-J147	30i/31i/32i/35i-B, PM i-A Fast Ethernet Board
A02B-0323-J561#658K	30i/31i/32i-B Fast Ethernet - Control Software
A02B-0323-J692	30i-B FL-Net Function
A02B-0323-S851	30i-B Safety Function by FL-Net
A02B-0326-J692	31i-B5 FL-Net Function
A02B-0326-S851	31i-B5 Safety Function by FL-Net
A02B-0327-J692	31i-B FL-Net Function
A02B-0327-S851	31i-B Safety Function by FL-Net

# 587

Specification	Description
A02B-0328-J692	32i-B FL-Net Function
A02B-0328-S851	32i-B Safety Function by FL-Net
A02B-0333-J561#658K	35i-B Fast Ethernet - Control Software
A02B-0333-J692	35i-B FL-Net Function
A02B-0333-S851	35i-B Safety Function by FL-Net
A02B-0334-J561#658K	PM i-A Fast Ethernet - Control Software
A02B-0334-J692	PM i-A FL-Net Function
A02B-0334-S851	PM i-A Safety Function by FL-Net
A02B-0339-S851	0i-TF Safety Function by FL-Net
A02B-0340-S851	0i-MF Safety Function by FL-Net

## Notice

Certain functions may require additional hardware, different CPU type or additional memory capacity or may cause compatibility issue with other functions. In case of doubt, contact your FANUC sales representative for additional information and support.

The information given in the FANUC manuals or original manufacturer documentation shall prevail. Technical data is subject to change without prior notice. No part of this document may be reproduced in any form. All rights reserved. © FANUC 2017

# 588

## Communication



# CC-Link Remote Device

## Features

The CC-Link Remote Device function and CC-Link board can be used to connect to the CNC to the CC-Link fieldbus of Mitsubishi Electric.

The CC-Link functions of the Series 30i/31i/32i-A/B can be operated as remote device stations (slave stations) and can communicate with control units compliant with CC-Link master stations.

Specification:

- Transfer rate (Baud rate): 156K/625K/2.5M/5M/10M bps.
- Station number: 1 to 64
- Number of occupied stations: 1 to 4
- Maximum transfer data size (when 4 stations are occupied):
  - Remote output RY: 16 bytes (128 bits), user area 14 bytes, system 2 bytes
  - Remote input RY: 16 bytes (128 bits), user area 14 bytes, system 2 bytes
  - Remote register RWw: 16 words (32 bytes)
  - Remote register RWr: 16 words (32 bytes)

Note:

- The CC-Link functions cannot be used simultaneously as the DeviceNet functions or the PROFIBUS-DP functions

## Benefits

- Connect to PLCs and equipment using CC-Link network
- Decrease of the time required to design and setup the system
- Improvement of machine flexibility and increase of the system efficiency / productivity

## Ordering Information

Specification	Description
A02B-0323-J320	30i/31i/32i/35i-B, PM i-A CC-LINK Remote Device Station Board
A02B-0323-J574#6591	30i/31i/32i-B CC-LINK Remote Device - Control Software
A02B-0323-R954	30i-B CC-LINK Remote Device Function
A02B-0326-R954	31i-B5 CC-LINK Remote Device Function
A02B-0327-R954	31i-B CC-LINK Remote Device Function
A02B-0328-R954	32i-B CC-LINK Remote Device Function
A02B-0333-J574#6591	35i-B CC-LINK Remote Device - Control Software
A02B-0333-R954	35i-B CC-LINK Remote Device Function

### Notice

Certain functions may require additional hardware, different CPU type or additional memory capacity or may cause compatibility issue with other functions. In case of doubt, contact your FANUC sales representative for additional information and support.

The information given in the FANUC manuals or original manufacturer documentation shall prevail. Technical data is subject to change without prior notice. No part of this document may be reproduced in any form. All rights reserved. © FANUC 2017

# 589

Specification	Description
A02B-0334-J574#6591	PM i-A CC-LINK Remote Device - Control Software
A02B-0334-R954	PM i-A CC-LINK Remote Device Function
A02B-0338-J320	0i-F CC-LINK Remote Device Board
A02B-0339-R954	0i-TF CC-LINK Remote Device Function
A02B-0340-R954	0i-MF CC-LINK Remote Device Function

## Notice

Certain functions may require additional hardware, different CPU type or additional memory capacity or may cause compatibility issue with other functions. In case of doubt, contact your FANUC sales representative for additional information and support.

The information given in the FANUC manuals or original manufacturer documentation shall prevail. Technical data is subject to change without prior notice. No part of this document may be reproduced in any form. All rights reserved. © FANUC 2017

# 590

## Communication

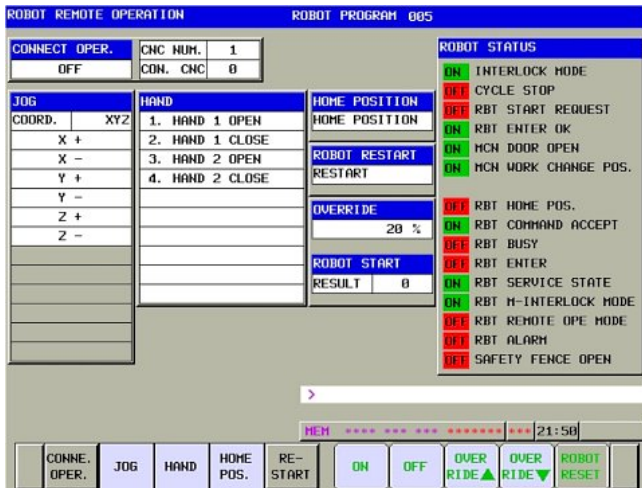

### Notice

Certain functions may require additional hardware, different CPU type or additional memory capacity or may cause compatibility issue with other functions. In case of doubt, contact your FANUC sales representative for additional information and support.

The information given in the FANUC manuals or original manufacturer documentation shall prevail. Technical data is subject to change without prior notice. No part of this document may be reproduced in any form. All rights reserved. © FANUC 2017

# Robot Connection Function

## Features

A standard interface between a FANUC robot and any machine tool equipped with a FANUC CNC significantly reduces the integration time and cost. Simple customizable wizards built into the robot pendant step the integrator through the settings for the I/O interface, grippers, programs and positions.

FANUC robots and up to four FANUC CNCs can be easily connected into a system using Ethernet or I/O Link. Robot operation and monitoring can be performed through one of integrated FANUC CNC screens in a cell without entering the safety zone of the robot. Custom CNC screens can be quickly created by the integrator using FANUC Picture to simplify the cell operation. Similarly, screens on the robot pendant can also be used for complete CNC and robot system operation and monitoring.

NCGuidePro and ROBOGUIDE simulators can be used on a PC to test, debug and program the integrated system. The integrated simulation systems can be used to teach the robot accurate workpiece exchange positions. CNC part programs can be executed and the total system operation can be visualized.

The Robot Connection Function provides the following functionalities:

- Connection of CNC and Robot
- Display of the robot status and operation (jog robot axes in "joint" or "cartesian" modes, issue macro programs for gripper control, etc.) on the CNC screen
- Display of CNC status and operation (jog of the feed axes, adjustment of tool offsets) on the iPendant of the Robot

To speed up the setup of this function on both Robot and CNC, robot connection sample programs are provided; it includes FANUC PICTURE sample screens for robot remote operation for the CNC as well as ladder programs for the CNC and the Robot. All programs can be customised if required.

## Benefits

- Easy connection of FANUC CNC and robots
- Time saving during development and setup
- Improvement of the system efficiency
- Decrease of the Total Cost of Ownership (TCO)

## Ordering Information

Specification	Description
A02B-0323-R683	30i-B Robot Connection Function - Machine Tool Connection Function (A05B-2500-J984) Required on Robot Control

# 591

Specification	Description
A02B-0326-R683	31i-B5 Robot Connection Function - Machine Tool Connection Function (A05B-2500-J984) Required on Robot Control
A02B-0327-R683	31i-B Robot Connection Function - Machine Tool Connection Function (A05B-2500-J984) Required on Robot Control
A02B-0328-R683	32i-B Robot Connection Function - Machine Tool Connection Function (A05B-2500-J984) Required on Robot Control
A02B-0333-R683	35i-B Robot Connection Function - Machine Tool Connection Function (A05B-2500-J984) Required on Robot Control
A02B-0334-R683	PM i-A Robot Connection Function - Machine Tool Connection Function (A05B-2500-J984) Required on Robot Control
A02B-0339-R683	0i-TF Robot Connection Function
A02B-0340-R683	0i-MF Robot Connection Function
A08B-9510-J550	30i/31i/32i-A, 30i/31i/32i/35i-B, PM i-A, 0i-D Robot Connection Function Sample Programs

## Notice

Certain functions may require additional hardware, different CPU type or additional memory capacity or may cause compatibility issue with other functions. In case of doubt, contact your FANUC sales representative for additional information and support.

The information given in the FANUC manuals or original manufacturer documentation shall prevail. Technical data is subject to change without prior notice. No part of this document may be reproduced in any form. All rights reserved. © FANUC 2017



# 592

## Communication



### Scanner

## EtherNet/IP Scanner

### Features

EtherNet/IP is an industrial network based on Ethernet. The specification of EtherNet/IP is managed by ODVA (Open DeviceNet Vendor Association) and its globalization and standardization are promoted. Therefore, EtherNet/IP has been adopted by many vendors, and it is possible to connect to various types of industrial devices. Moreover, EtherNet/IP devices can be used together with general-purpose Ethernet devices because a standard Ethernet technology is used.

The EtherNet/IP Scanner function provides the CNC with the capability to act as an EtherNet/IP Scanner (Master) to connect the CNC to an EtherNet/IP device environment. This function provides an easy way to setup the system installation and the connection to popular PLCs and I/O devices using EtherNet/IP.

When using multicast between up to 32 CNC, it is possible to realize simple shared memory, which greatly simplifies network management and allows, for instance, an overview of the status of each machine of a line on each CNC.

The EtherNet/IP Scanner function can be used with the following Ethernet hardware:

- The "Fast Ethernet board" of the Series 30i/31i/32i/35i-B CNC and the Power Motion i-A
- The "Multi-Function Ethernet module" of the Series 30i/31i/32i/35i-B and Power Motion i-A LCD-Mounted type

Notes:

- Refer to the connection manual for additional information about the EtherNet/IP data type supported, the size of the data tables, programming, EDS file as well as the function specifications.
- The Ethernet hardware of the CNC supports several concurrent protocols and connections. Refer to the connection manuals for details and limitations that may exist.
- It is possible to run the EtherNet/IP Scanner and Adapter function on the same Ethernet hardware module or on different modules. Refer to the connection manuals for details and limitations that may exist.
- If the EtherNet/IP Scanner function and the EtherNet/IP PORT2 function are specified, the EtherNet/IP Scanner function can be operated on different hardware boards at the same time.

### Benefits

- Connection to PLCs and equipment by EtherNet/IP network
- Acceleration of the system installation and commissioning
- Improvement of machine flexibility and increase of the system efficiency / productivity

### Ordering Information

Specification	Description
A02B-0323-J147	30i/31i/32i/35i-B, PM i-A Fast Ethernet Board
A02B-0323-J561#658K	30i/31i/32i-B Fast Ethernet - Control Software

#### Notice

Certain functions may require additional hardware, different CPU type or additional memory capacity or may cause compatibility issue with other functions. In case of doubt, contact your FANUC sales representative for additional information and support.

The information given in the FANUC manuals or original manufacturer documentation shall prevail. Technical data is subject to change without prior notice. No part of this document may be reproduced in any form. All rights reserved. © FANUC 2017

Specification	Description
A02B-0323-R966	30i-B Ethernet/IP Scanner Function
A02B-0323-R973	30i-B Ethernet/IP Scanner Port 2 Function
A02B-0323-S707	30i-B Ethernet Function
A02B-0326-R966	31i-B5 Ethernet/IP Scanner Function
A02B-0326-R973	31i-B5 Ethernet /IP Scanner Port 2 Function
A02B-0326-S707	31i-B5 Ethernet Function
A02B-0327-R966	31i-B Ethernet/IP Scanner Function
A02B-0327-R973	31i-B Ethernet/IP Scanner Port 2 Function
A02B-0327-S707	31i-B Ethernet Function
A02B-0328-R966	32i-B Ethernet/IP Scanner Function
A02B-0328-R973	32i-B Ethernet/IP Scanner Port 2 Function
A02B-0328-S707	32i-B Ethernet Function
A02B-0333-J561#658K	35i-B Fast Ethernet - Control Software
A02B-0333-R966	35i-B Ethernet/IP Scanner Function
A02B-0333-R973	35i-B Ethernet/IP Scanner Port 2 Function
A02B-0333-S707	35i-B Ethernet Function
A02B-0334-J561#658K	PM i-A Fast Ethernet - Control Software
A02B-0334-R966	PM i-A Ethernet/IP Scanner Function
A02B-0334-R973	PM i-A Ethernet/IP Scanner Port 2 Function
A02B-0334-S707	PM i-A Ethernet Function
A02B-0339-R966	0i-TF Ethernet/IP Scanner Function
A02B-0340-R966	0i-MF Ethernet/IP Scanner Function

## Notice

Certain functions may require additional hardware, different CPU type or additional memory capacity or may cause compatibility issue with other functions. In case of doubt, contact your FANUC sales representative for additional information and support.

The information given in the FANUC manuals or original manufacturer documentation shall prevail. Technical data is subject to change without prior notice. No part of this document may be reproduced in any form. All rights reserved. © FANUC 2017



## EtherNet/IP Adapter

### Features

EtherNet/IP is an industrial network based on Ethernet. The specification of EtherNet/IP is managed by ODVA (Open DeviceNet Vendor Association) and its globalization and standardization are promoted. Therefore, EtherNet/IP has been adopted by many vendors, and it is possible to connect to various types of industrial devices. Moreover, EtherNet/IP devices can be used together with general-purpose Ethernet devices because a standard Ethernet technology is used.

The EtherNet/IP Adapter function provides the CNC with the capability to act as an EtherNet/IP Adapter (Slave) to connect the CNC to an EtherNet/IP environment. This function provides an easy way to setup the system installation and the connection to popular PLCs and equipment using EtherNet/IP.

When using multicast between up to 32 CNC, it is possible to realize simple shared memory, which greatly simplifies network management and allows, for instance, an overview of the status of each machine of a line on each CNC.

The EtherNet/IP Adapter function can be used with the following Ethernet hardware:

- The "Fast Ethernet board" of the Series 30i/31i/32i/35i-B CNC and the Power Motion i-A
- The "Multi-Function Ethernet module" of the Series 30i/31i/32i/35i-B and Power Motion i-A LCD-Mounted type

Notes:

- Refer to the connection manual for additional information on the EtherNet/IP data type supported, the size of the data tables, settings, EDS files as well as the function specifications.
- The Ethernet hardware of the CNC supports several concurrent protocols and connections. Refer to the connection manuals for details and limitations that may exist.
- It is possible to run the EtherNet/IP Scanner and Adapter function on the same Ethernet hardware module or on different modules. Refer to the connection manuals for details and limitations that may exist.
- If the EtherNet/IP Adapter function and the EtherNet/IP PORT2 function are specified, the EtherNet/IP Adpater function can be operated on different hardware boards at the same time.

### Benefits

- Connection to PLCs and machines by EtherNet/IP network
- Acceleration of the system installation and commissioning
- Improvement of the system uptime and efficiency

### Ordering Information

Specification	Description
A02B-0323-J147	30i/31i/32i/35i-B, PM i-A Fast Ethernet Board
A02B-0323-J561#658K	30i/31i/32i-B Fast Ethernet - Control Software

#### Notice

Certain functions may require additional hardware, different CPU type or additional memory capacity or may cause compatibility issue with other functions. In case of doubt, contact your FANUC sales representative for additional information and support.

The information given in the FANUC manuals or original manufacturer documentation shall prevail. Technical data is subject to change without prior notice. No part of this document may be reproduced in any form. All rights reserved. © FANUC 2017

Specification	Description
A02B-0323-R967	30i-B Ethernet/IP Adapter Function
A02B-0323-R974	30i-B Ethernet/IP Adapter Port 2 Function
A02B-0323-S707	30i-B Ethernet Function
A02B-0326-R967	31i-B5 Ethernet/IP Adapter Function
A02B-0326-R974	31i-B5 Ethernet/IP Adapter Port 2 Function
A02B-0326-S707	31i-B5 Ethernet Function
A02B-0327-R967	31i-B Ethernet/IP Adapter Function
A02B-0327-R974	31i-B Ethernet/IP Adapter Port 2 Function
A02B-0327-S707	31i-B Ethernet Function
A02B-0328-R967	32i-B Ethernet/IP Adapter Function
A02B-0328-R974	32i-B Ethernet/IP Adapter Port 2 Function
A02B-0328-S707	32i-B Ethernet Function
A02B-0333-J561#658K	35i-B Fast Ethernet - Control Software
A02B-0333-R967	35i-B Ethernet/IP Adapter Function
A02B-0333-R974	35i-B Ethernet/IP Adapter Port 2 Function
A02B-0333-S707	35i-B Ethernet Function
A02B-0334-J561#658K	PM i-A Fast Ethernet - Control Software
A02B-0334-R967	PM i-A Ethernet/IP Adapter Function
A02B-0334-R974	PM i-A Ethernet/IP Adapter Port 2 Function
A02B-0334-S707	PM i-A Ethernet Function
A02B-0339-R967	0i-TF Ethernet/IP Adapter Function
A02B-0340-R967	0i-MF Ethernet/IP Adapter Function

## Notice

Certain functions may require additional hardware, different CPU type or additional memory capacity or may cause compatibility issue with other functions. In case of doubt, contact your FANUC sales representative for additional information and support.

The information given in the FANUC manuals or original manufacturer documentation shall prevail. Technical data is subject to change without prior notice. No part of this document may be reproduced in any form. All rights reserved. © FANUC 2017

# 596

## Communication



# EtherNet/IP Adapter Safety Function

## Features

The EtherNet/IP Adapter Safety function makes it possible for the EtherNet/IP Adapter function to handle safety signals. The communication standard is based on CIP-Safety managed by the ODVA (Open DeviceNet Vendor Association). This function enables the CNC to exchange safety signals with an EtherNet/IP Scanner device that supports CIP-Safety.

## Benefits

- Connect the CNC to a Safety PLC via EtherNet/IP
- Improvement of machine flexibility

## Ordering Information

Specification	Description
A02B-0323-R976	30i-B Ethernet/IP Adapter Safety Function
A02B-0326-R976	31i-B5 Ethernet/IP Adapter Safety Function
A02B-0327-R976	31i-B Ethernet/IP Adapter Safety Function
A02B-0328-R976	32i-B Ethernet/IP Adapter Safety Function
A02B-0333-R976	35i-B ETHERNET/IP Adapter Safety Function
A02B-0334-R976	PM i-A ETHERNET/IP Adapter Safety Function
A02B-0339-R976	0i-TF Ethernet/IP Adapter Safety Function
A02B-0340-R976	0i-MF Ethernet/IP Adapter Safety Function

### Notice

Certain functions may require additional hardware, different CPU type or additional memory capacity or may cause compatibility issue with other functions. In case of doubt, contact your FANUC sales representative for additional information and support.

The information given in the FANUC manuals or original manufacturer documentation shall prevail. Technical data is subject to change without prior notice. No part of this document may be reproduced in any form. All rights reserved. © FANUC 2017

# 597

## Communication



# Modbus/TCP Server

## Features

Modbus/TCP Server function enables the connection to PLCs and equipment via the Modbus protocol over Ethernet. Modbus is a very popular protocol which is available on many automation devices. The Modbus/TCP function provides an easy way to setup the system installation and the connection to many PLCs, supervision systems and equipment using Modbus/TCP.

The Modbus/TCP Server function can be used on the following Ethernet hardware:

- The "embedded Ethernet port" of the Series 30i/31i/32i/35i-B CNC and Power Motion i-A
- The "Fast Ethernet board" of the Series 30i/31i/32i-A CNC, the Series 30i/31i/32i/35i-B CNC, the Power Motion i-A and the Series 0i-D CNC
- The "Multi-Function Ethernet module" of the Series 30i/31i/32i/35i-B and Power Motion i-A LCD-Mounted type

Notes:

- When Modbus/TCP is used on the "embedded Ethernet port" of the CNC, the number of clients connected at the same time to the CNC is limited to 3 instead of 10 for the "Fast Ethernet board" or the "Multi-Function Ethernet Module".
- Refer to the connection manual for additional information on the Modbus/TCP data type supported, the size of the data tables as well as the function specifications.
- The Ethernet hardware of the CNC supports several concurrent protocols and connections. Refer to the connection manuals for details and limitations that may exist.

## Benefits

- Connect to PLCs and equipment by ModBus/TCP network over Ethernet
- Acceleration of the system installation and commissioning
- Improvement of machine flexibility and increase of the system efficiency / productivity

## Ordering Information

Specification	Description
A02B-0323-J147	30i/31i/32i/35i-B, PM i-A Fast Ethernet Board
A02B-0323-J561#658K	30i/31i/32i-B Fast Ethernet - Control Software
A02B-0323-R968	30i-B Modbus/TCP Server Function
A02B-0323-S707	30i-B Ethernet Function
A02B-0326-R968	31i-B5 Modbus/TCP Server Function
A02B-0326-S707	31i-B5 Ethernet Function
A02B-0327-R968	31i-B Modbus/TCP Server Function

### Notice

Certain functions may require additional hardware, different CPU type or additional memory capacity or may cause compatibility issue with other functions. In case of doubt, contact your FANUC sales representative for additional information and support.

The information given in the FANUC manuals or original manufacturer documentation shall prevail. Technical data is subject to change without prior notice. No part of this document may be reproduced in any form. All rights reserved. © FANUC 2017

Specification	Description
A02B-0327-S707	31i-B Ethernet Function
A02B-0328-R968	32i-B Modbus/TCP Server Function
A02B-0328-S707	32i-B Ethernet Function
A02B-0333-J561#658K	35i-B Fast Ethernet - Control Software
A02B-0333-R968	35i-B Modbus/TCP Server Function
A02B-0333-S707	35i-B Ethernet Function
A02B-0334-J561#658K	PM i-A Fast Ethernet - Control Software
A02B-0334-R968	PM i-A Modbus/TCP Server Function
A02B-0334-S707	PM i-A Ethernet Function
A02B-0339-R968	0i-TF Modbus/TCP Server Function
A02B-0340-R968	0i-MF Modbus/TCP Server Function

## Notice

Certain functions may require additional hardware, different CPU type or additional memory capacity or may cause compatibility issue with other functions. In case of doubt, contact your FANUC sales representative for additional information and support.

The information given in the FANUC manuals or original manufacturer documentation shall prevail. Technical data is subject to change without prior notice. No part of this document may be reproduced in any form. All rights reserved. © FANUC 2017

# 599

## Communication



Controller and Device

# PROFINET I/O Controller

## Features

PROFINET is an industrial network using Ethernet. It enables I/O communication between I/O Controller and I/O Devices. The communication standard is managed by PI (PROFIBUS and PROFINET International).

The PROFINET I/O Controller function provides an easy way to setup the CNC system to connect to popular PLCs and I/O devices equipment using PROFINET.

The PMC Allocation Expansion of PROFINET I/O Controller function expands the maximum number of PMC allocations in the PMC multiple allocation mode from 48 to 256.

## Benefits

- I/O signals can be exchanged faster than PROFIBUS
- This function cannot be operated together with following functions on the same hardware.
  1. Ethernet function (S707)
  2. Modbus/TCP server function (R968)
  3. Data Server function (S737)
  4. FL-Net function (J692)
  5. EthernetIP Scanner function (R966)
  6. EthernetIP Adapter function (R967)
  7. Profinet I/O Device function (R972)
- It is possible to use this function at the same time by using other hardware (Fast Ethernet card).

## Ordering Information

Specification	Description
A02B-0323-J564#658R	30i/31i/32i-B PROFINET I/O Software
A02B-0323-R971	30i-B PROFINET I/O Controller Function
A02B-0323-R979	30i-B PMC Allocation Expansion of PROFINET I/O Controller Function
A02B-0326-R971	31i-B5 PROFINET I/O Controller Function
A02B-0326-R979	31i-B5 PMC Allocation Expansion of PROFINET I/O Controller Function
A02B-0327-R971	31i-B PROFINET I/O Controller Function
A02B-0327-R979	31i-B PMC Allocation Expansion of PROFINET I/O Controller Function
A02B-0328-R971	32i-B PROFINET I/O Controller Function
A02B-0328-R979	32i-B PMC Allocation Expansion of PROFINET I/O Controller Function
A02B-0333-J564#658R	35i-B PROFINET I/O Software

### Notice

Certain functions may require additional hardware, different CPU type or additional memory capacity or may cause compatibility issue with other functions. In case of doubt, contact your FANUC sales representative for additional information and support.

The information given in the FANUC manuals or original manufacturer documentation shall prevail. Technical data is subject to change without prior notice. No part of this document may be reproduced in any form. All rights reserved. © FANUC 2017



# 600

Specification	Description
A02B-0333-R971	35i-B PROFINET I/O Controller Function
A02B-0333-R979	35i-B PMC Allocation Expansion of PROFINET I/O Controller Function
A02B-0334-J564#658R	PM i-A PROFINET I/O Software - Control Software
A02B-0334-R971	PM i-A PROFINET I/O Controller Function
A02B-0334-R979	PM i-A PMC Allocation Expansion of PROFINET I/O Controller Function
A02B-0339-R971	0i-TF Profinet I/O Controller Function
A02B-0340-R971	0i-MF Profinet I/O Controller Function

## Notice

Certain functions may require additional hardware, different CPU type or additional memory capacity or may cause compatibility issue with other functions. In case of doubt, contact your FANUC sales representative for additional information and support.

The information given in the FANUC manuals or original manufacturer documentation shall prevail. Technical data is subject to change without prior notice. No part of this document may be reproduced in any form. All rights reserved. © FANUC 2017

# 601

## Communication



Controller and Device

## PROFINET I/O Device

### Features

PROFINET is an industrial network using Ethernet. It enables I/O communication between I/O Controller and I/O Devices. The communication standard is managed by PI (PROFIBUS and PROFINET International).

The PROFINET-I/O Device (Slave) function for the Fast Ethernet board or the Multi-Function Ethernet module provides an easy way to setup the system installation and the connection of the CNC system to popular PLCs and equipment using PROFINET-I/O.

It provides up to 256 bytes of input and 256 bytes of output data to a PROFINET I/O Controller.

PROFINET is available for the Series 30i/31i/32i/35i-B CNC and the Power Motion i-A.

Notes:

- Refer to the connection manual for additional information on the PROFINET-I/O Device data type supported, the size of the data, settings and GSDML files.
- The Ethernet hardware of the CNC supports several concurrent protocols and connections. Refer to the connection manuals for details and limitations that may exist.

### Benefits

- Connection to PLCs and equipment by PROFINET-I/O network
- Acceleration of the system installation and commissioning
- Improvement of machine flexibility and increase of the system efficiency / productivity

### Ordering Information

Specification	Description
A02B-0323-J147	30i/31i/32i/35i-B, PM i-A Fast Ethernet Board
A02B-0323-J561#658K	30i/31i/32i-B Fast Ethernet - Control Software
A02B-0323-R972	30i-B PROFINET I/O Device Function
A02B-0326-R972	31i-B5 PROFINET I/O Device Function
A02B-0327-R972	31i-B PROFINET I/O Device Function
A02B-0328-R972	32i-B PROFINET I/O Device Function
A02B-0333-J561#658K	35i-B Fast Ethernet - Control Software
A02B-0333-R972	35i-B PROFINET I/O Device Function
A02B-0334-J561#658K	PM i-A Fast Ethernet - Control Software
A02B-0334-R972	PM i-A PROFINET I/O Device Function

#### Notice

Certain functions may require additional hardware, different CPU type or additional memory capacity or may cause compatibility issue with other functions. In case of doubt, contact your FANUC sales representative for additional information and support.

The information given in the FANUC manuals or original manufacturer documentation shall prevail. Technical data is subject to change without prior notice. No part of this document may be reproduced in any form. All rights reserved. © FANUC 2017

# 602

Specification	Description
A02B-0339-R972	0i-TF Profinet I/O Device Function
A02B-0340-R972	0i-MF Profinet I/O Device Function

## Notice

Certain functions may require additional hardware, different CPU type or additional memory capacity or may cause compatibility issue with other functions. In case of doubt, contact your FANUC sales representative for additional information and support.

The information given in the FANUC manuals or original manufacturer documentation shall prevail. Technical data is subject to change without prior notice. No part of this document may be reproduced in any form. All rights reserved. © FANUC 2017

# 603

## Communication



Controller and Device

# PROFINET I/O Device Safety Function

## Features

The PROFINET I/O Device Safety function makes it possible for the PROFINET I/O Device function to handle safety signals. The communication standard is based on the Safety standard PROFIsafe managed by PI (PROFIBUS and PROFINET International). This function enables the CNC to exchange safety signals with a PROFINET I/O Controller that supports PROFIsafe.

## Benefits

- Connect the CNC to a Safety PLC via PROFINET
- Improvement of machine flexibility

## Ordering Information

Specification	Description
A02B-0323-R977	30i-B PROFINET I/O Device Safety Function (Slave I/O Device)
A02B-0326-R977	31i-B5 PROFINET I/O Device Safety Function (Slave I/O Device)
A02B-0327-R977	31i-B PROFINET I/O Device Safety Function (Slave I/O Device)
A02B-0328-R977	32i-B PROFINET I/O Device Safety Function (Slave I/O Device)
A02B-0333-R977	35i-B PROFINET I/O Device Safety Function (Slave I/O Device)
A02B-0334-R977	PM i-A PROFINET I/O Device Safety Function (Slave I/O Device)
A02B-0339-R977	0i-TF PROFINET I/O Device Safety Function (Slave I/O Device)
A02B-0340-R977	0i-MF PROFINET I/O Device Safety Function (Slave I/O Device)

### Notice

Certain functions may require additional hardware, different CPU type or additional memory capacity or may cause compatibility issue with other functions. In case of doubt, contact your FANUC sales representative for additional information and support.

The information given in the FANUC manuals or original manufacturer documentation shall prevail. Technical data is subject to change without prior notice. No part of this document may be reproduced in any form. All rights reserved. © FANUC 2017

# 604

## Communication

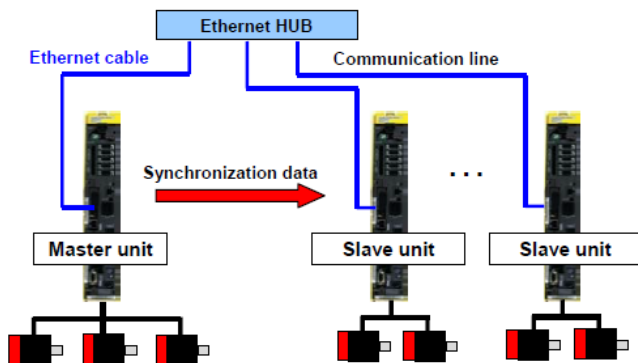

## Inter-Unit Synchronization (Power Motion i-A)

### Features

With Inter-Unit Synchronization, it is possible to synchronize axes that are controlled by different Power Motion controllers. Up to 7 slave units can be connected to one master unit by an Ethernet-based communication line. Any axis on a slave unit can be synchronized with an axis on the master unit. Up to 256 synchronized axes can be controlled this way.

The Inter-Unit Synchronous Board has to be mounted on each unit. The Multi-Axes Synchronous function and the FL-net function options are required to use Inter-Unit Synchronization.

### Benefits

- Synchronize more than 32 axes

### Ordering Information

Specification	Description
A02B-0334-J149	PM i-A Inter-Unit Synchronous Board

#### Notice

Certain functions may require additional hardware, different CPU type or additional memory capacity or may cause compatibility issue with other functions. In case of doubt, contact your FANUC sales representative for additional information and support.

The information given in the FANUC manuals or original manufacturer documentation shall prevail. Technical data is subject to change without prior notice. No part of this document may be reproduced in any form. All rights reserved. © FANUC 2017

# 605

## CNC

## Software

---

This section groups all the different software products that are used when dealing with CNC systems such as

- Software for Operator Control (e.g. Manual Guide)
- Development Software (e.g. FANUC Ladder, C-Executor, ...)
- PC Operating Software (e.g. Windows®)
- HMI Software (e.g. FANUC Picture)



### Notice

Certain functions may require additional hardware, different CPU type or additional memory capacity or may cause compatibility issue with other functions. In case of doubt, contact your FANUC sales representative for additional information and support.

The information given in the FANUC manuals or original manufacturer documentation shall prevail. Technical data is subject to change without prior notice. No part of this document may be reproduced in any form. All rights reserved. © FANUC 2017

# 606

## Software

# CNC Application Development Kit

## Features

The CNC Application Development Kit is a software package that contains various tools and applications that are useful for machine tool builder. This package contains the following applications:

- Acceptance Test Assist Tool
- Basic Operation Package 2
- C-Language Library for C-Language Executor
- CNC Screen Display Function
- Electronic Cam Support Tool
- FANUC PICTURE
- FOCAS2 Library
- Guidance Table for Machine Alarm Diagnosis
- Ladder Editing Package
- Machine Operation Menu Making Tool
- Machining Status Monitor Package
- Macro Library
- Main Menu Screen Customization Tool
- Operation History Converter Tool

Please refer to the following pages for details on a particular application.

## Ordering Information

Specification	Description
A08B-9010-J555#ZZ12	CNC Application Development Kit

### Notice

Certain functions may require additional hardware, different CPU type or additional memory capacity or may cause compatibility issue with other functions. In case of doubt, contact your FANUC sales representative for additional information and support.

The information given in the FANUC manuals or original manufacturer documentation shall prevail. Technical data is subject to change without prior notice. No part of this document may be reproduced in any form. All rights reserved. © FANUC 2017

# 607 Software

## Acceptance Test Assist Tool

### Features

The Acceptance Test Assist Tool is a Windows® application running on a Personal Computer which can assist the machine builder during the acceptance test procedure of Dual Check Safety through automated tests and report generation. This application provides the following two functions:

- Execution of the acceptance tests connected to the CNC
- Generation of test reports for the test result to create the final test certificate

The application provides a set of templates to enter the required data and generates a report which can be then further enhanced with Microsoft® Word (.docx format).

The Acceptance Test Assist Tool is part of the CNC Application Development Kit.

### Benefits

- Decrease of the time required to proceed the Dual Check Safety acceptance test
- Automated generation of key report data to save time on the redaction of the final acceptance test documents

Test running screen

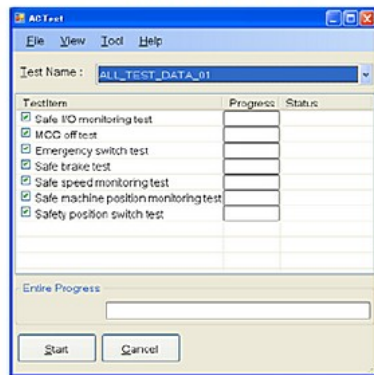

Report making screen

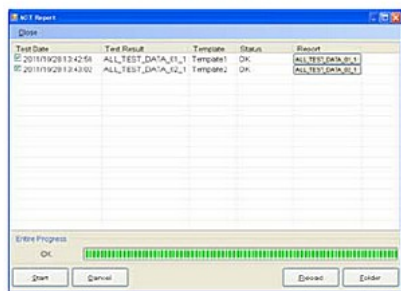

Report



### Notice

Certain functions may require additional hardware, different CPU type or additional memory capacity or may cause compatibility issue with other functions. In case of doubt, contact your FANUC sales representative for additional information and support.

The information given in the FANUC manuals or original manufacturer documentation shall prevail. Technical data is subject to change without prior notice. No part of this document may be reproduced in any form. All rights reserved. © FANUC 2017



# 608 Software

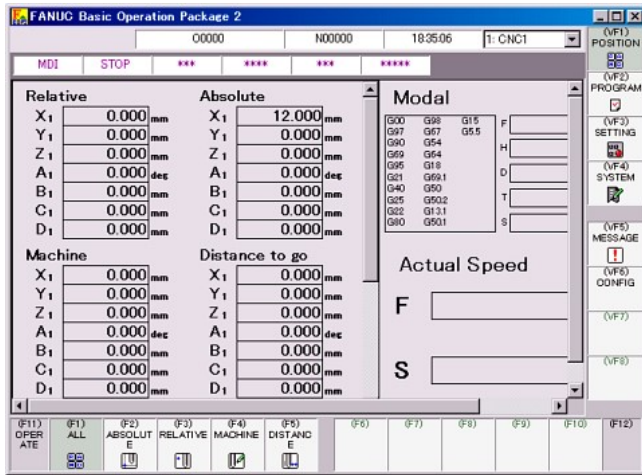

## Basic Operation Package 2

### Features

The Basic Operation Package 2 is a native Windows® software which allows the CNC operations on a PC.

It offers the same comfort and operability in order that users of FANUC CNC can quickly become familiar with the system. Basic Operation Package 2 can be customized to even increase the operability and efficiency and match the machine requirement. Screens can be added, modified or removed.

The Basic Operation Package 2 is designed to be used with a Personal Computer display connected via HSSB or Ethernet to a FANUC CNC.

Basic Operation Package 2 is based on Microsoft® .NET Framework®. Screens can be created / modified using simple XML configuration. It is available for the Series 30i-MODEL A/B CNC Family and the Series 0i-MODEL D CNC Family. It is also usable on the legacy CNC Series 16-MODEL C and Series 16i-MODEL A/B family.

The Basic Operation Package 2 installation files are also part of the CNC Application Development Kit.

### Benefits

- Simplified implementation of the CNC operation for a Personal Computer
- Simple and efficient customization

### Ordering Information

Specification	Description
A02B-0207-J816	Basic Operation Package 2 Function [BOP 2]
A02B-0207-K755	Basic Operation Package 2 - HSSB / Ethernet, CD-ROM - BOP 2 [Enhanced Step 2]

#### Notice

Certain functions may require additional hardware, different CPU type or additional memory capacity or may cause compatibility issue with other functions. In case of doubt, contact your FANUC sales representative for additional information and support.

The information given in the FANUC manuals or original manufacturer documentation shall prevail. Technical data is subject to change without prior notice. No part of this document may be reproduced in any form. All rights reserved. © FANUC 2017

# 609 Software

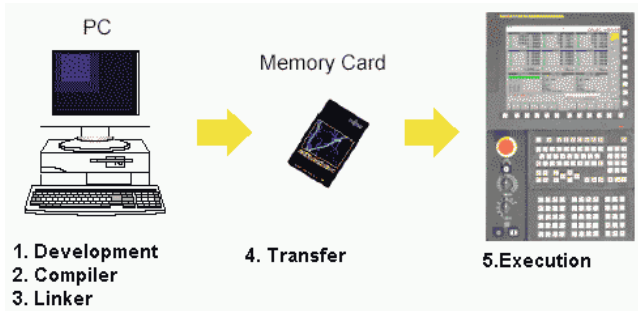

## Notice

Certain functions may require additional hardware, different CPU type or additional memory capacity or may cause compatibility issue with other functions. In case of doubt, contact your FANUC sales representative for additional information and support.

The information given in the FANUC manuals or original manufacturer documentation shall prevail. Technical data is subject to change without prior notice. No part of this document may be reproduced in any form. All rights reserved. © FANUC 2017

# C-Language Library for C-Language Executor

## Features

FANUC CNC provides a powerful set of tools to allow custom software developed in C to access the CNC functions.

Using the C-Language Executor functionality it is possible to develop customized CNC screens and powerful Human Machine Interfaces (HMI). It is also possible to add new functionality to the CNC, as well as machine control functions written in C.

The C-Language Library for C-Language Executor is a software library that allows custom software to access the CNC functions and be executed by the C-Language Executor functionality.

The C-Language Executor Library is for the conversion of FS16i/18i/21i-B PMC C-language board applications to C-Language Executor applications. The C-Language Library for C-Language Executor is required.

The C-Language Library for C-Language Executor is part of the CNC Application Development Kit.

## Benefits

- Creation of customized functions and programs using C-Language
- Modification of Macro Programs to follow machine and production evolution
- Powerful programming language for machining or machine management purpose

## Ordering Information

Specification	Description
A08B-9210-J719#ZZ11	C-Language Executor Library

# 610 Software

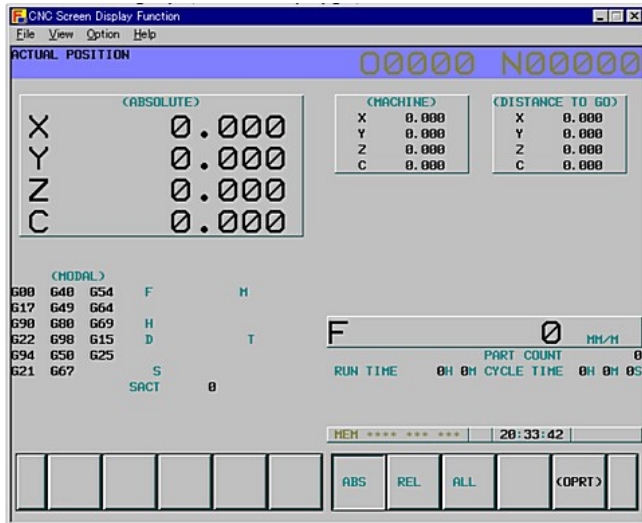

## CNC Screen Display Function (SDF)

### Features

The CNC Screen Display Function (SDF) Windows® application provides a straight-forward tool to display the CNC screens on PC. The CNC can be connected to the PC running the SDF application via Ethernet or HSSB.

Because of the special structure of the SDF application, it is not necessary to update SDF if some new functions are added to the CNC. This makes SDF the best tool for CNC maintenance and setup on Open CNC systems.

The CNC Screen Display function installation files are also part of the CNC Application Development Kit.

### Benefits

- Simplified access to the CNC screen from a Personal Computer
- Simple and efficient remote maintenance tool

### Ordering Information

Specification	Description
A02B-0207-J858	CNC Screen Display Function - Specify "Extended Drivers and Libraries" for HSSB Connection, or Specify "Ethernet Function" for Fast Ethernet Connection
A02B-0207-J896	30i/31i/32i-B Windows Embedded Compact 7 - CNC Screen Display Function
A02B-0207-K775	CNC Screen Display Function Disk (HSSB) - Specify for Each PANEL i / PC when Using SDF via HSSB
A02B-0207-K776	CNC Screen Display Function Disk (Ethernet) - Specify for Each PANEL i / PC when Using SDF via Ethernet

#### Notice

Certain functions may require additional hardware, different CPU type or additional memory capacity or may cause compatibility issue with other functions. In case of doubt, contact your FANUC sales representative for additional information and support.

The information given in the FANUC manuals or original manufacturer documentation shall prevail. Technical data is subject to change without prior notice. No part of this document may be reproduced in any form. All rights reserved. © FANUC 2017

# 611 Software

## Electronic Cam Support Tool

### Features

The cam shape data for the electronic cam function can be created easily with the electronic cam support tool. The cam shape data is defined by setting the stroke position and the curve shape for each phase. It is possible to confirm the position, velocity, acceleration and jerk of the cam shape data visually by a graphical display. The cam shape data is output to a file, which has to be read in by the CNC via memory card.

The Electronic Cam Support Tool is part of the CNC Application Development Kit.

### Benefits

- Simplifies the creation of cam shape data for the electronic cam function

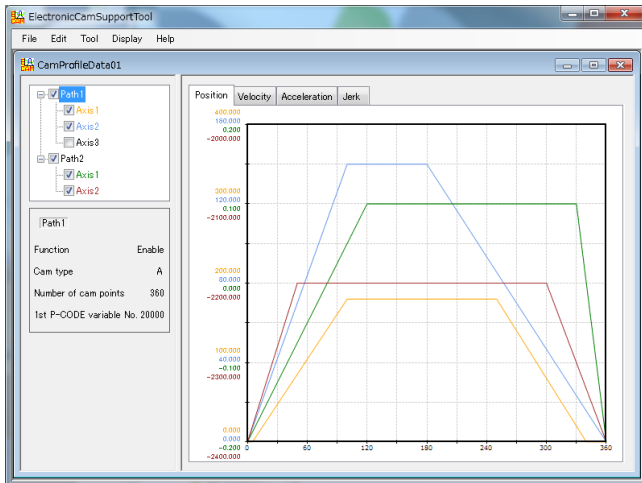

### Notice

Certain functions may require additional hardware, different CPU type or additional memory capacity or may cause compatibility issue with other functions. In case of doubt, contact your FANUC sales representative for additional information and support.

The information given in the FANUC manuals or original manufacturer documentation shall prevail. Technical data is subject to change without prior notice. No part of this document may be reproduced in any form. All rights reserved. © FANUC 2017

# 612 Software

## FANUC PICTURE

### Features

The FANUC PICTURE software provides a rich set of functions and tools to design and implement customized Human Machine Interfaces (HMI) on the FANUC CNC.

The projects created by FANUC PICTURE are compiled to a format that can be executed directly by the CNC and displayed on the standard LCD screen without requiring additional Personal Computer display.

### Key functions

- Support of many screen sizes and resolutions
- Support of touch screens, including virtual keypads
- WYSIWYG editor
- Rich set of controls such as keys, switches, push buttons, touch buttons, lamps, scales, etc.
- Many parameters can be adjusted for each of the objects
- No need to program, just draw and parameter
- Support of multi-language HMI application
- Easy import-export of projects, variables, descriptions and translations
- Script language (scheduled or event driven) to execute complex tasks

FANUC PICTURE is part of the CNC Application Development Kit.

### Benefits

- Creation of customized HMI on the FANUC CNC
- Powerful HMI without the requirement of PC hardware
- Simple modification of the HMI to follow machine and production evolution

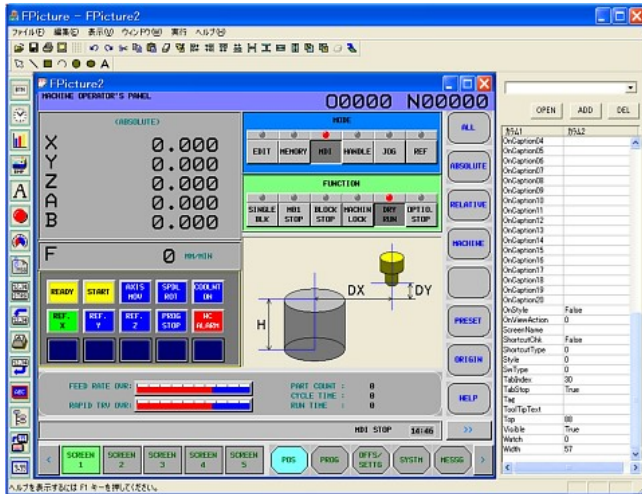

### Notice

Certain functions may require additional hardware, different CPU type or additional memory capacity or may cause compatibility issue with other functions. In case of doubt, contact your FANUC sales representative for additional information and support.

The information given in the FANUC manuals or original manufacturer documentation shall prevail. Technical data is subject to change without prior notice. No part of this document may be reproduced in any form. All rights reserved. © FANUC 2017

# 613

## Software

# FANUC

## FOCAS2 Library

CNC/PMC Data window library

## FOCAS2 Library

---

### Features

FOCAS2 (FANUC Open CNC API Specification) is the protocol used to be able to interact with the FANUC CNC from an external Personal Computer (PC).

The FOCAS2 library provides all required functions to be able to develop Windows® applications which can communicate with a FANUC CNC via either Ethernet or HSSB (fiber optics).

### Key functions

- Reading/writing data related to controlled axes/spindle
- Operations related to CNC program
- Reading/writing CNC file data
- Reading/writing tool life management data
- Reading history data
- Reading servo/spindle data
- Reading/writing data related to Data Server, DNC1, DNC2, OSI-Ethernet (HSSB version only)
- Reading/writing waveform diagnosis data
- Reading/writing data related to PUNCH PRESS CNC
- Reading/writing data related to LASER CNC
- Reading/writing data related to servo learning data (HSSB version only)
- Reading/writing of other data (diagnostic data, alarm information, operator messages, etc.)
- Reading/writing data related to PMC
- Reading/writing data related to PROFIBUS-DP

The FOCAS2 Library is part of the CNC Application Development Kit.

### Benefits

- Creation of customized functions and applications under Windows®
- Modification of Macro Programs to follow machine and production evolution
- Easy access to many resources of the FANUC CNC to create advanced applications

#### Notice

Certain functions may require additional hardware, different CPU type or additional memory capacity or may cause compatibility issue with other functions. In case of doubt, contact your FANUC sales representative for additional information and support.

The information given in the FANUC manuals or original manufacturer documentation shall prevail. Technical data is subject to change without prior notice. No part of this document may be reproduced in any form. All rights reserved. © FANUC 2017

# 614 Software

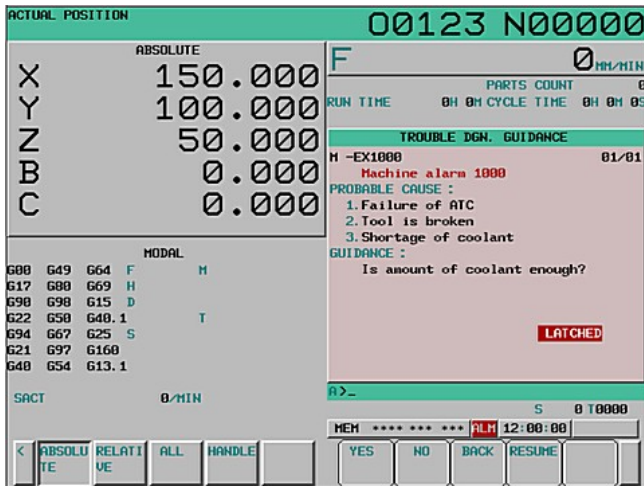

## Guidance Table for Machine Alarm Diagnosis

### Features

The machine alarms (external alarm messages, external operator messages and macro alarms) can be diagnosed on the "trouble diagnosis guidance screen" in addition to standard CNC alarms.

In addition to the alarm, the CNC will propose a list of possible causes of the problem and propose a guidance. The guidance can be answered with YES / NO, and depending on the answers, other hints and guidance will appear.

The Guidance Table for Machine Alarm Diagnosis is a Windows® application for the Personal Computer that provides a set of tool to create the guidance parts and the structure of the questions / answers that will guide the operator. Once this data has been created, it can be transferred to the CNC with the tool.

The Guidance Table for Machine Alarm Diagnosis application is part of the CNC Application Development Kit.

### Benefits

- Creation of a powerful guidance system to diagnose the machine
- The diagnosis Q and A / guidance application is directly integrated in the CNC and does not require any additional hardware
- Decrease of the time required to diagnose problems at the operator level
- General increase of the productivity of the machine

### Notice

Certain functions may require additional hardware, different CPU type or additional memory capacity or may cause compatibility issue with other functions. In case of doubt, contact your FANUC sales representative for additional information and support.

The information given in the FANUC manuals or original manufacturer documentation shall prevail. Technical data is subject to change without prior notice. No part of this document may be reproduced in any form. All rights reserved. © FANUC 2017

# 615 Software

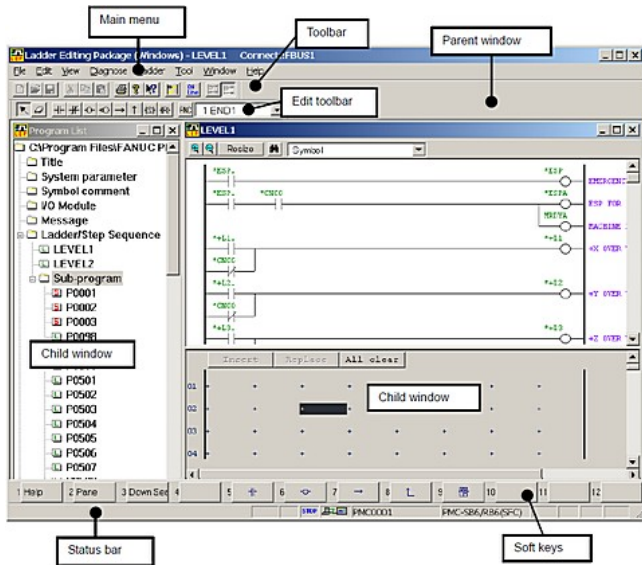

## LADDER Editing Package Execute Files

### Features

LADDER Editing Package is a programming system for developing, diagnosing and maintaining sequence programs for CNC PMC ladder, FANUC's integrated PLC.

The LADDER Editing Package has been designed as a Windows® application which can reside on the Personal Computer display unit connected to a FANUC CNC (Open CNC).

### Key functions

- Creating, displaying, editing and printing ladder sequence programs
- Monitoring and debugging ladder sequence programs
- Program monitoring
- PMC signal status display
- PMC signal trace
- Writing to flash ROM
- Connection to the CNC via Ethernet
- Works with NCGuidePro on one or multiple PCs

The LADDER Editing Package installation files are part of the CNC Application Development Kit.

### Benefits

- Creation of the machine PMC program, startup and debug
- Modification of the PMC program to follow machine and production evolution
- Rich maintenance and diagnostics capabilities of the PMC and machine control

### Ordering Information

Specification	Description
A02B-0207-J820	FANUC LADDER Editing Package - Ethernet

### Notice

Certain functions may require additional hardware, different CPU type or additional memory capacity or may cause compatibility issue with other functions. In case of doubt, contact your FANUC sales representative for additional information and support.

The information given in the FANUC manuals or original manufacturer documentation shall prevail. Technical data is subject to change without prior notice. No part of this document may be reproduced in any form. All rights reserved. © FANUC 2017



# 616 Software

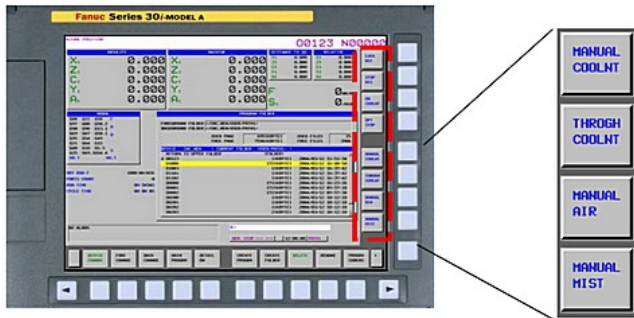

## Machine Operation Menu Making Tool

### Features

The softkey displayed on the CNC screen can be also used as keys for the operation of the machine. The machine operation such as turning on or off the coolant, that is usually done with the machine operator's panel, can be done with a softkey on the CNC screen instead.

Using this function, it is not required to add additional hardware to add additional operation function to the CNC; it is realized with software.

The hierarchy of the menus, the operation and the displayed text strings can be easily set with the "Machine Operation Menu Tool" on the Personal Computer.

The Machine Operation Menu Making Tool is part of the CNC Application Development Kit.

### Benefits

- Simple customization of the CNC softkeys
- Realization of simple machine control menus

#### Notice

Certain functions may require additional hardware, different CPU type or additional memory capacity or may cause compatibility issue with other functions. In case of doubt, contact your FANUC sales representative for additional information and support.

The information given in the FANUC manuals or original manufacturer documentation shall prevail. Technical data is subject to change without prior notice. No part of this document may be reproduced in any form. All rights reserved. © FANUC 2017

# 617

## Software

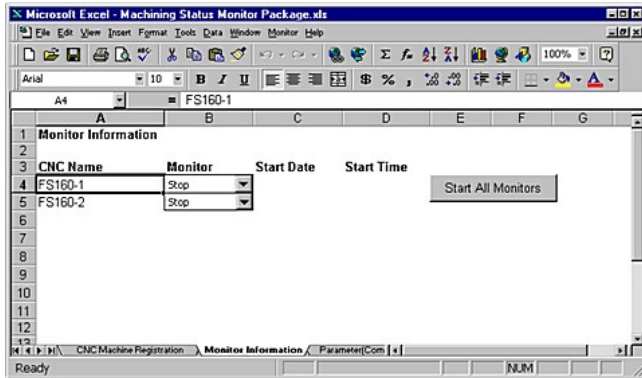

# Machining Status Monitor Package Disk

## Features

The Machining Status Monitor Package provides a simple connection capability between the CNC and Microsoft® Excel.

### Key functions

- The machining status monitor package outputs the logging data in the form of Microsoft Excel. All the functions of Excel can be used (spreadsheet functions or charts).
- The running results of the program and the number of processed parts can be monitored and output as the logging data.
- The data acquired from the CNC machine and the logging data output can be customized
- Maximum number of CNC machines that can be monitored: up to 8 machines (HSSB) or 32 machines (Ethernet)

The Machining Status Monitor Package installation files are part of the CNC Application Development Kit.

## Benefits

- Realisation of simple data logging and monitoring application
- Increase of the efficiency (Machine Tool Efficiency)

## Ordering Information

Specification	Description
A02B-0207-J870	Machine Status Monitor Package Function

### Notice

Certain functions may require additional hardware, different CPU type or additional memory capacity or may cause compatibility issue with other functions. In case of doubt, contact your FANUC sales representative for additional information and support.

The information given in the FANUC manuals or original manufacturer documentation shall prevail. Technical data is subject to change without prior notice. No part of this document may be reproduced in any form. All rights reserved. © FANUC 2017

# 618

## Software

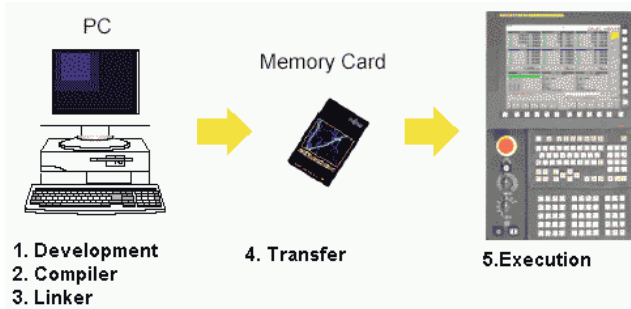

### Notice

Certain functions may require additional hardware, different CPU type or additional memory capacity or may cause compatibility issue with other functions. In case of doubt, contact your FANUC sales representative for additional information and support.

The information given in the FANUC manuals or original manufacturer documentation shall prevail. Technical data is subject to change without prior notice. No part of this document may be reproduced in any form. All rights reserved. © FANUC 2017

# MACRO Compiler and Library

## Features

Some NC programs such as technology functions or programs created using custom macros do not need to be modified once created. Other NC programs, such as machining programs, evolve during machining.

The Macro Executor function can convert a Custom Macro program created by the machine tool builder to an executable macro program, load the executable macro program (P-CODE macro) into F-ROM (CNC Flash Memory), and execute it.

The function which converts a Custom Macro program to an Executable Macro program is called the Macro Compiler. The function which reads and executes a P-CODE macro is called the Macro Executor.

The Macro Library is part of the CNC Application Development Kit.

## Key functions

- High execution speed of the code, since a custom macro program is loaded after conversion and compilation to an executable so that the machining time can be reduced and the machining precision can be improved.
- Custom Macro used in Technology Modules cannot be destroyed because they are loaded into the FROM (CNC Flash Memory)
- A program converted to execution format is not displayed on the program screen, so that the know-how and the technology can be protected
- An execution format macro program is registered in the F-ROM, so that the program storage space can be efficiently used
- The user can call the execution format macro program with an easy call procedure without being conscious of the complexity of the program itself
- Custom screens can be created using the graphic display functions
- Extension of the CNC control function set (machining functions, interactive screens, RS232 (reader/puncher) interface control, PMC data read/write , etc.)

## Benefits

- Creation of customized functions and programs
- Modification of Macro Programs to follow machine and production evolution
- Powerful programming language for machining or machine management purpose

## Ordering Information

Specification	Description
A08B-9010-J604#EN11	Macro Compiler, CNC Series 30i/31i/32i, 0i-D/0i-Mate-D

# 619

Specification	Description
A08B-9010-J605#EN11	Macro Compiler Upgrade, CNC Series 30i/31i/32i, 0i-D/0i-Mate-D, 0i-F

**Notice**

Certain functions may require additional hardware, different CPU type or additional memory capacity or may cause compatibility issue with other functions. In case of doubt, contact your FANUC sales representative for additional information and support.

The information given in the FANUC manuals or original manufacturer documentation shall prevail. Technical data is subject to change without prior notice. No part of this document may be reproduced in any form. All rights reserved. © FANUC 2017

# 620 Software

## Main Menu Screen Customization Tool

### Features

The Main Menu Screen Customization Tool can customize the main menu screen of a CNC by personal computer. This software can perform the following customization:

- Edit of multi language title of categories
- Moving, addition, deletion of an icon
- Edit of multi language title of icons
- Edit of image of icons

The Main Menu Screen Customization Tool is part of the CNC Application Development Kit.

### Benefits

- Easy customization on PC
- To use customization by this software on CNC a option is required.

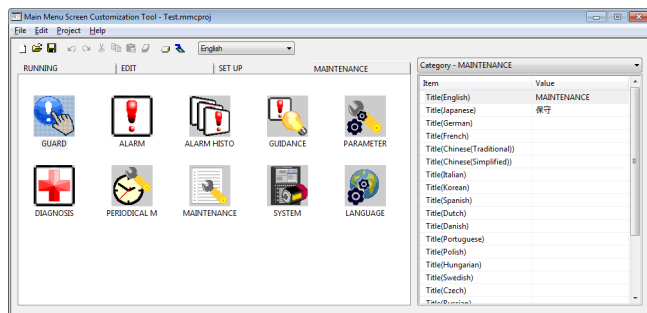

### Notice

Certain functions may require additional hardware, different CPU type or additional memory capacity or may cause compatibility issue with other functions. In case of doubt, contact your FANUC sales representative for additional information and support.

The information given in the FANUC manuals or original manufacturer documentation shall prevail. Technical data is subject to change without prior notice. No part of this document may be reproduced in any form. All rights reserved. © FANUC 2017

# 621

## Software

# Operation History Converter Tool

---

## Features

If the operation history save function is active in a CNC, older operation history data is saved to a Compact Flash card as a binary file. The operation history converter tool is a Windows® application which converts this binary file into a human-readable text file.

The Operation History Converter Tool is part of the CNC Application Development Kit.

## Benefits

- Facilitates long-term operation data analysis

### Notice

Certain functions may require additional hardware, different CPU type or additional memory capacity or may cause compatibility issue with other functions. In case of doubt, contact your FANUC sales representative for additional information and support.

The information given in the FANUC manuals or original manufacturer documentation shall prevail. Technical data is subject to change without prior notice. No part of this document may be reproduced in any form. All rights reserved. © FANUC 2017

# 622 Software

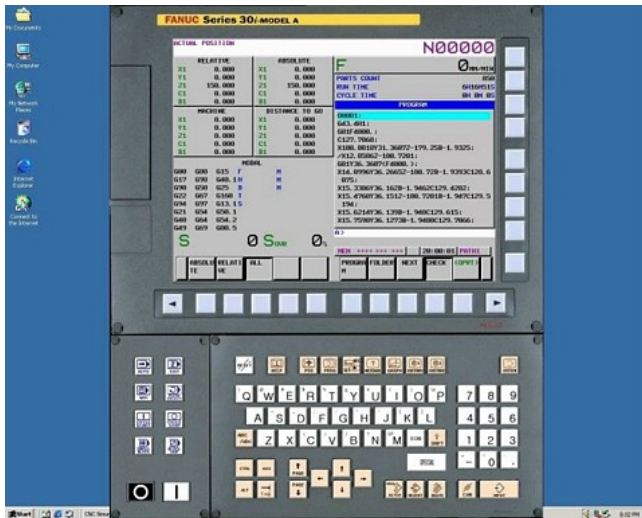

## NCGuide

### Features

NCGuide and NCGuide Academic Package are FANUC's CNC software running on a PC. They are available with single or multiseat licences. This is the ideal solution for a dedicated training room or development team.

#### NCGuide

NCGuide provides a realistic operation and part programming environment at a fraction of the cost of using a production machine tool. This translates into lower training costs. It supports both conventional G-code programming, including canned cycles and custom macros, and FANUC's conversational programming, MANUAL GUIDE i.

Comprehension and retention is enhanced as students perform repetitive hands-on exercises in an ergonomically friendly environment - away from the noise of the factory floor. Operators, programmers, and maintenance engineers can all practice common procedures and develop optimized processes without risks to people, tooling or machines.

- The simulation emulates the CNC exactly, which means programs can be written, tested and optimized on the PC bringing productivity gains by working offline and keeping the machine in production.
- Simulators fit to a classroom situation and so both educational and industrial training is easily implemented resulting in better educated and highly motivated staff.

NCGuide provides a superior software development environment for FANUC CNCs, by adding the PMC ladder and machine signal simulation capabilities, and support for the standard FANUC operator panel. When combined with other FANUC software development tools (FANUC LADDER III, FANUC PICTURE, C- and MACRO EXECUTER), NCGuide provides a more efficient development environment than an actual CNC.

### Ordering Information

Specification	Description
A08B-9010-J770#ZZ12	FANUC NCGuide, 1 User (DVD-R) - Simulation of CNC / MANUAL GUIDE i on PC
A08B-9010-J771#ZZ12	FANUC NCGuide, 10 User (DVD-R) - Simulation of CNC / MANUAL GUIDE i on PC
A08B-9010-J772#ZZ12	FANUC NCGuide, 20 User (DVD-R) - Simulation of CNC / MANUAL GUIDE i on PC
A08B-9010-J773#ZZ12	FANUC NCGuide, Site License (DVD-R) - Simulation of CNC / MANUAL GUIDE i on PC
A08B-9010-J774#ZZ12	FANUC NCGuide (DVD-R) - Update of A08B-9010-J770#ZZ12 - ...-J773#ZZ12

#### Notice

Certain functions may require additional hardware, different CPU type or additional memory capacity or may cause compatibility issue with other functions. In case of doubt, contact your FANUC sales representative for additional information and support.

The information given in the FANUC manuals or original manufacturer documentation shall prevail. Technical data is subject to change without prior notice. No part of this document may be reproduced in any form. All rights reserved. © FANUC 2017

# 623

## NCGuide

# Cycle Time Estimate Function for NCGuide

## Features

The Cycle Time Estimation Function is a Personal Computer tool that can quickly estimate the machining cycle time of NC program. With this function, the following estimations are delivered by the software (refer to illustration):

- Travel distance [1]
- Cycle time [2]
- Path drawing [3]

## Key highlights

- The accuracy of the estimation made is higher than estimations made with 3rd party software; the reason of this higher accuracy is that the cycle time is calculated including the acceleration / deceleration
- The target program can be selected and the NC parameter can be set as on a real machine and CNC using NCGuide / NCGuidePro
- The machining time of a complex program can be estimated, for example from a 5-axis machining cycle

## Details of the estimated data

Because not only the entire cycle time of specified NC program but also time of rapid traverse and cutting, as well as distance are calculated, the tool provides a very efficient method to optimize machining cycles, decrease the processing time and extend the tool life.

The Estimation Function is available for the program of machining center and one path and provides the following details:

- Entire processing time
- Rapid traverse time
- Cutting feed time (calculated with the time of acceleration / deceleration but without taking in consideration the lag provided by the servo motors, the spindle and the machine time)
- Processing time of miscellaneous functions (the total of the time of each M/S/T/B code set beforehand is multiplied at the entire processing time)
- Macro processing time (Custom Macro and Execution Macro can be executed except that the macro processing time is not included in the entire processing time)
- Rapid traverse distance
- Cutting feed distance (traveled distance of the tool center point is calculated)

## Supported CNC

Series 30i/31i/32i-MODEL B

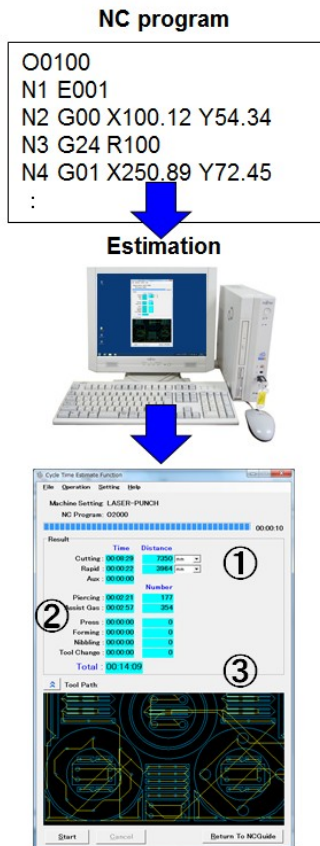

### Notice

Certain functions may require additional hardware, different CPU type or additional memory capacity or may cause compatibility issue with other functions. In case of doubt, contact your FANUC sales representative for additional information and support.

The information given in the FANUC manuals or original manufacturer documentation shall prevail. Technical data is subject to change without prior notice. No part of this document may be reproduced in any form. All rights reserved. © FANUC 2017



## Accuracy

The accuracy of the estimation time depends on many factors, but essentially is linked to the type of machining process. The estimation reaches a higher accuracy under the following conditions:

- When the processing time of the estimated machining duration is longer
- When the ratio of cutting and rapid traverse is higher
- When the ratio of miscellaneous function is lower

## Benefits

- Optimization of machining cycles (reduction of time, increase of accuracy and reduction of tool wear)
- Increase of the machine productivity
- Reduction of trials with real cutting, especially for expensive materials

## Ordering Information

Specification	Description
A08B-9010-J753#ZZ12	Disk for Cycle Time Estimate Function (for NCGuide), DVD
A08B-9010-J757#ZZ12	Disk for Cycle Time Estimate Function (for NCGuide), DVD - Update

### Notice

Certain functions may require additional hardware, different CPU type or additional memory capacity or may cause compatibility issue with other functions. In case of doubt, contact your FANUC sales representative for additional information and support.

The information given in the FANUC manuals or original manufacturer documentation shall prevail. Technical data is subject to change without prior notice. No part of this document may be reproduced in any form. All rights reserved. © FANUC 2017

# 625

## NCGuide



## NCGuide Academic Package

### Features

The NCGuide Academic Package is a special variant of NCGuide for schools and universities. It's the ideal tool for individual or group training. To suit educational purposes, the Functionality has been reduced and the license model has been adapted.

### Ordering Information

Specification	Description
A08B-9010-J751#ZZ12	FANUC NCGuide Academic Package (Classroom) - License for 16 PCs Connected to Network (DVD)
A08B-9010-J752#ZZ12	FANUC NCGuide Academic Package (Student) - License for 1 PC Not Connected to Network, Valid for 1 Year (DVD)
A08B-9010-J761#ZZ12	FANUC NCGuide Academic Package (Classroom) - Licence for 32 Users
A08B-9010-J762#ZZ12	FANUC NCGuide Academic Package (Homework) - Licence for 1 User, Valid for 3 Years

#### Notice

Certain functions may require additional hardware, different CPU type or additional memory capacity or may cause compatibility issue with other functions. In case of doubt, contact your FANUC sales representative for additional information and support.

The information given in the FANUC manuals or original manufacturer documentation shall prevail. Technical data is subject to change without prior notice. No part of this document may be reproduced in any form. All rights reserved. © FANUC 2017

# 626 Software

## FANUC Auto HMI-NC disk

### Features

FANUC Auto HMI-NC is an application composed of a set of HMI templates, objects, tables and scripts to create standardized user interfaces in automotive applications or machining applications producing large batches of products.

Refer to the "FANUC Auto HMI-NC" section of this catalogue for further information about this application.

The disk contains the template files for various configurations and screen sizes, variable maps as well as documentation.

### Benefits

- Powerfull ready-made application templates and variable tables
- Customizable through FANUC PICTURE

### Ordering Information

Specification	Description
A08B-9010-J519#ZZ11	FANUC Auto HMI-NC, CD-ROM - Development of Machine Operation Screens
A08B-9010-J524#ZZ11	FANUC Auto HMI/T, CD-ROM - Development of Machine Operation Panel Screens
A08B-9510-J931	FANUC Auto HMI PC Application for Proficy Machine Edition - Standard

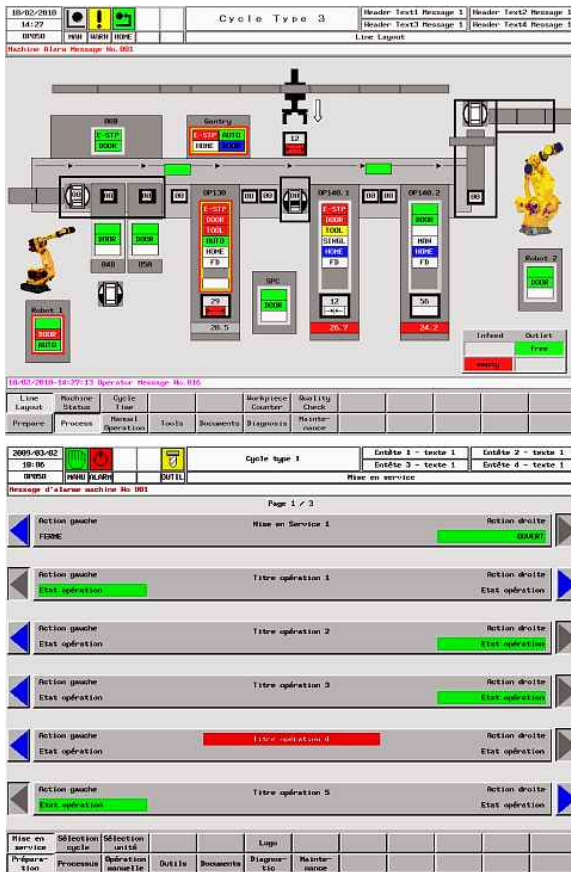

### Notice

Certain functions may require additional hardware, different CPU type or additional memory capacity or may cause compatibility issue with other functions. In case of doubt, contact your FANUC sales representative for additional information and support.

The information given in the FANUC manuals or original manufacturer documentation shall prevail. Technical data is subject to change without prior notice. No part of this document may be reproduced in any form. All rights reserved. © FANUC 2017

# 627

## Software

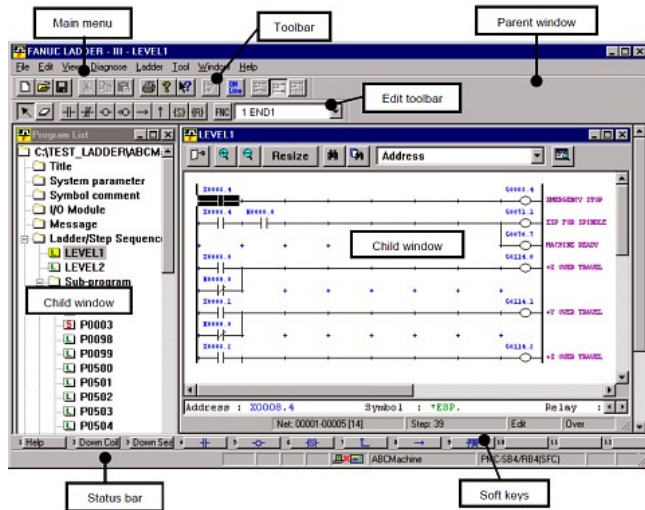

## FANUC Ladder-III

### Features

FANUC LADDER-III is the standard programming system for developing, diagnosing and maintaining sequence programs for CNC PMC ladder, FANUC's integrated PLC.

### Key functions

- Creating, displaying, editing and printing ladder sequence programs
- Monitoring and debugging ladder sequence programs
- Support of the creation, debugging and management of Function Blocks
- Program monitoring
- PMC signal status display
- PMC signal trace
- Writing to flash ROM
- Connection to the CNC via Ethernet
- Works with NCGuidePro on one or multiple PCs

### Supported PMC Types

- CNC Series 30i/31i/32i/35i-MODEL Band Power Motion i-MODEL A (refer to the PMC Programming Manual B-64513EN)
- CNC Series 30i/31i/32i-MODEL A (refer to the PMC Programming Manual B-63983EN)
- CNC Series 0i-MODEL D, and Series 0i Mate-MODEL D (refer to PMC Programming Manual B-64393EN)
- Legacy PMC systems MODEL PA1 / PA3 / SA1 / SA2 / SA3 / SA5 / SB / SB2 / SB3 / SB4 / SB5 / SB6 / SB7 / SC / SC3 / SC4 / NB / NB2 / NB6 (refer to the Ladder Language Programming Manual B-61863E)

### Benefits

- Creation of the machine PMC program, startup and debug
- Modification of the PMC program to follow machine and production evolution
- Rich maintenance and diagnostics capabilities of the PMC and machine control

### Ordering Information

Specification	Description
A02B-0200-K814	RS232C Cable for Programm Transmission and Online Monitor: PC (SUB-D 9 Pins) <--> Punch Panel (SUB-D 25 Pins), Length 7 m

#### Notice

Certain functions may require additional hardware, different CPU type or additional memory capacity or may cause compatibility issue with other functions. In case of doubt, contact your FANUC sales representative for additional information and support.

The information given in the FANUC manuals or original manufacturer documentation shall prevail. Technical data is subject to change without prior notice. No part of this document may be reproduced in any form. All rights reserved. © FANUC 2017

# 628

Specification	Description
A08B-9210-J505	FANUC LADDER III - for Windows 95 / 98 / NT 4.0 / 2000 / XP / Vista / 7 (32-Bit), Release 6.3 or later
A08B-9210-J541	FANUC LADDER III (10 Users) Japanese / English
A08B-9210-J542	FANUC LADDER III (20 Users) Japanese / English
A08B-9210-J543	FANUC LADDER III (Site License) Japanese / English
A08B-9210-J544	FANUC LADDER III (Update) Japanese / English

## Notice

Certain functions may require additional hardware, different CPU type or additional memory capacity or may cause compatibility issue with other functions. In case of doubt, contact your FANUC sales representative for additional information and support.

The information given in the FANUC manuals or original manufacturer documentation shall prevail. Technical data is subject to change without prior notice. No part of this document may be reproduced in any form. All rights reserved. © FANUC 2017

# 629 Software

## FANUC SERVO GUIDE

### Features

FANUC SERVO GUIDE is a Windows® application that allows a quick and easy optimization of servos and spindles axes.

This software provides the integrated environment to test programs, set parameters and data measurement, needed for servo and spindle tuning.

Direct connection is possible between the Personal Computer and CNC through Ethernet.

### Key functions

- Easy connection to the CNC
- Integrated working environment for tuning machine servo and spindles
- Integrated and optimized environment for creating, tuning and optimizing programs, measuring data and changing parameters
- Measurement of servo and spindle data as well as external triggering events from the PMCat once
- many automatic adjustment functions

### 3-D View function

With this function, it is possible to view the result X, Y and Z coordinate data of the 3-D graph captured by SERVO GUIDE. 3-D graph and time-based waveform are displayed in the same window, and a point on 3-D graph easily corresponds to the point on time axis.

For example, it is possible to display tool path of machining center by capturing position data of X, Y and Z axis. By selecting points on the tool path, you can check waveforms of each servo axis, which corresponds to the selected area. 5-axis machining is also supported. Position of 5 axes are converted to tool center point, and 3-D path of tool is visualized. In addition, axis configuration including Cs axis(spindle axis) is also supported.

### Benefits

- Optimization of the
- Modification of the PMC program to follow machine and production evolution
- Rich maintenance and diagnostics capabilities of the PMC and machine control

#### Notice

Certain functions may require additional hardware, different CPU type or additional memory capacity or may cause compatibility issue with other functions. In case of doubt, contact your FANUC sales representative for additional information and support.

The information given in the FANUC manuals or original manufacturer documentation shall prevail. Technical data is subject to change without prior notice. No part of this document may be reproduced in any form. All rights reserved. © FANUC 2017

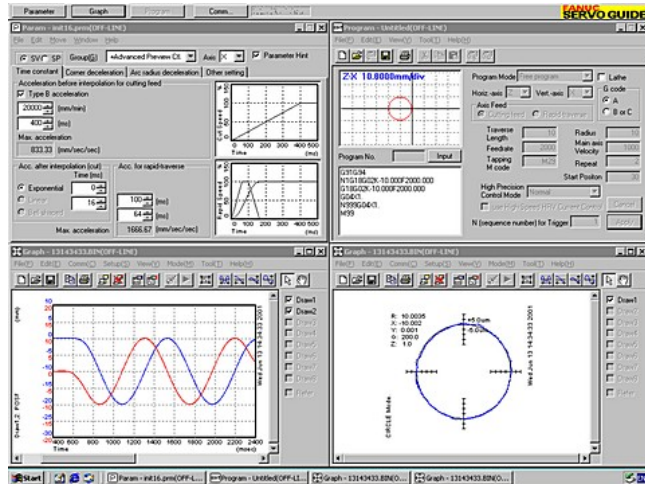

# 630

## Ordering Information

Specification	Description
A08B-9010-J522#ZZ11	FANUC SERVO GUIDE MATE Display
A08B-9010-J900	FANUC SERVO GUIDE Servo Tuning Tool - 1 User
A08B-9010-J902	FANUC SERVO GUIDE Servo Tuning Tool - Graph Edition (Wave Form Measurement)
A08B-9010-J904	FANUC SERVO GUIDE Servo Tuning Tool - 3-D View Function (Also Contains Upgrade for FANUC SERVO GUIDE A08B-9010-J900)
A08B-9010-J910	FANUC SERVO GUIDE Servo Tuning Tool - 10 Users
A08B-9010-J919	FANUC SERVO GUIDE Servo Tuning Tool - Upgrade
A08B-9010-J920	FANUC SERVO GUIDE Servo Tuning Tool - 20 Users
A08B-9010-J930	FANUC SERVO GUIDE Servo Tuning Tool - Site License

### Notice

Certain functions may require additional hardware, different CPU type or additional memory capacity or may cause compatibility issue with other functions. In case of doubt, contact your FANUC sales representative for additional information and support.

The information given in the FANUC manuals or original manufacturer documentation shall prevail. Technical data is subject to change without prior notice. No part of this document may be reproduced in any form. All rights reserved. © FANUC 2017

# 631 Software

## 3D Error Compensation Setting Tool

### Features

Every machine tool is afflicted with some kind of geometric errors. These errors affect the machine's precision and hence the quality of the machined parts. They can be compensated according to position in 3-dimensional space by using one of the following functions:

- 3-Dimensional Error Compensation
- 3-Dimensional Rotary Error Compensation

This Windows® software converts measured errors as defined in ISO 230-1 into 3-dimensional error compensation data. The compensation data can be transferred to a CNC directly via HSSB or Ethernet, or it can be stored into a compensation data file and transferred to a CNC by e.g. a CF card.

### Benefits

- Simplify the creation of compensation data for 3-Dimensional Error Compensation and 3-Dimensional Rotary Error Compensation

### Ordering Information

Specification	Description
A08B-9010-J727#ZZ11	3-D Error Compensation Setting Tool

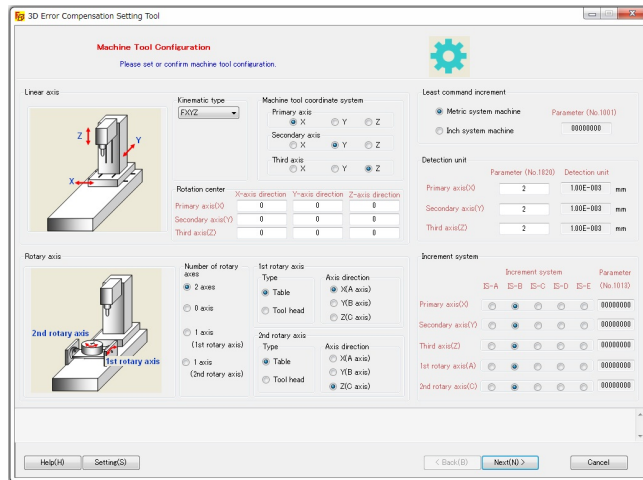

### Notice

Certain functions may require additional hardware, different CPU type or additional memory capacity or may cause compatibility issue with other functions. In case of doubt, contact your FANUC sales representative for additional information and support.

The information given in the FANUC manuals or original manufacturer documentation shall prevail. Technical data is subject to change without prior notice. No part of this document may be reproduced in any form. All rights reserved. © FANUC 2017



# 632 Software

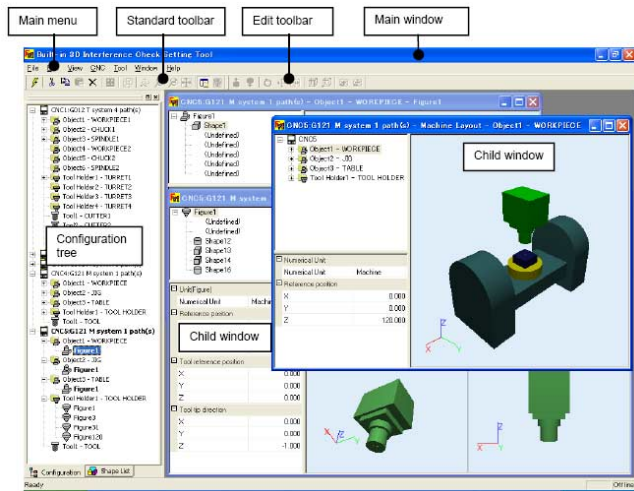

## Built-In 3D Interference Check Setting Tool

### Features

The Built-in 3D Interference Check Setting Tool is a Windows® application that allows the setting of the Series 30i/31i Built-In 3D Interference Check functions through a Personal Computer

### Key functions

- Creation, setting and display of the 3D objects and figures representing the work piece, the fixtures and the tools
- Object moving and axis settings
- Real-time 3D interference check monitoring
- Setting of the NC parameters 10931 to 10958 related to the Built-In 3D Interference Check Function

### Benefits

- Simplified management of the 3D Interference Check Project
- Import of 3D shapes to accelerate the setup
- Increase of the efficiency in managing multiple machine settings and large projects
- Simplified startup through online functions

### Ordering Information

Specification	Description
A08B-9010-J726#ZZ11	Built-in 3-D Interference Check Setting Tool

### Notice

Certain functions may require additional hardware, different CPU type or additional memory capacity or may cause compatibility issue with other functions. In case of doubt, contact your FANUC sales representative for additional information and support.

The information given in the FANUC manuals or original manufacturer documentation shall prevail. Technical data is subject to change without prior notice. No part of this document may be reproduced in any form. All rights reserved. © FANUC 2017

# 633

## Software

# CNC Setting Tool

---

## Features

CNC Setting Tool is a Windows® application software that can be used to display and edit parameter files. The software consists of three different setting tools and a file management function for the parameter files. The setting tools are:

- CNC Parameter Setting Tool
- FL-net Setting Tool
- PROFIBUS Setting Tool

Please refer to the following pages for details on a particular tool.

## Ordering Information

Specification	Description
A08B-9510-J540	CNC Setting Tool, 1 User
A08B-9510-J541	CNC Setting Tool, 10 Users
A08B-9510-J542	CNC Setting Tool, 20 User
A08B-9510-J543	CNC Setting Tool, Site License
A08B-9510-J544	CNC Setting Tool, Update - Updating CNC Setting Tool A08B-9510-J540 ... -J543

### Notice

Certain functions may require additional hardware, different CPU type or additional memory capacity or may cause compatibility issue with other functions. In case of doubt, contact your FANUC sales representative for additional information and support.

The information given in the FANUC manuals or original manufacturer documentation shall prevail. Technical data is subject to change without prior notice. No part of this document may be reproduced in any form. All rights reserved. © FANUC 2017

# 634 CNC Setting Tool

## CNC Parameter Setting Tool

### Features

CNC Setting tool is a Windows® application that can be used to display and edit CNC parameter files on Personal Computer.

### Key functions

- Display and edit of a parameter file
- All parameters can be displayed in order
- Parameters can be displayed in the order of function
- Explanation of selected parameters
- Range check when changing limited parameters
- Comparison of master file and edited file
- Management of parameter files operated by CNC setting tool (Copy, Delete)
- Transfer of parameter files between CNC and PC (Ethernet or Memory card)
- Extract parameters and save them to the file
- Combine parameter files to create new parameter file

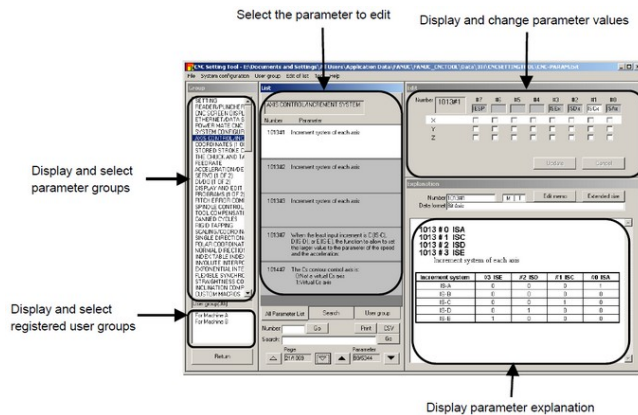

### Benefits

- Simplified management of the CNC parameter setting
- Increase of the efficiency in managing multiple machine settings

### Notice

Certain functions may require additional hardware, different CPU type or additional memory capacity or may cause compatibility issue with other functions. In case of doubt, contact your FANUC sales representative for additional information and support.

The information given in the FANUC manuals or original manufacturer documentation shall prevail. Technical data is subject to change without prior notice. No part of this document may be reproduced in any form. All rights reserved. © FANUC 2017

# 635

## CNC Setting Tool

# FL-net Setting Tool

## Features

The FL-net Setting Tool is a Windows® application used to efficiently set FL-net parameters in the CNC from a Personal Computer. The tool simplifies the management of large FL-net network sets.

This software tool can generate FL-net parameters for the CNC using configuration screens, especially focused on providing a clear definition of the shared memory across the different devices. The generated parameters are transferred to the CNC via Ethernet.

## Benefits

- Simplified management of FL-net network settings
- Increase of the efficiency in managing multiple machine settings and large networking projects

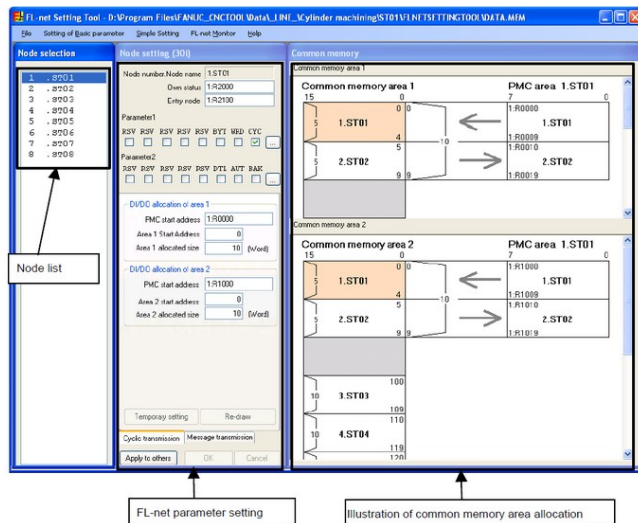

## Notice

Certain functions may require additional hardware, different CPU type or additional memory capacity or may cause compatibility issue with other functions. In case of doubt, contact your FANUC sales representative for additional information and support.

The information given in the FANUC manuals or original manufacturer documentation shall prevail. Technical data is subject to change without prior notice. No part of this document may be reproduced in any form. All rights reserved. © FANUC 2017

# 636

## CNC Setting Tool

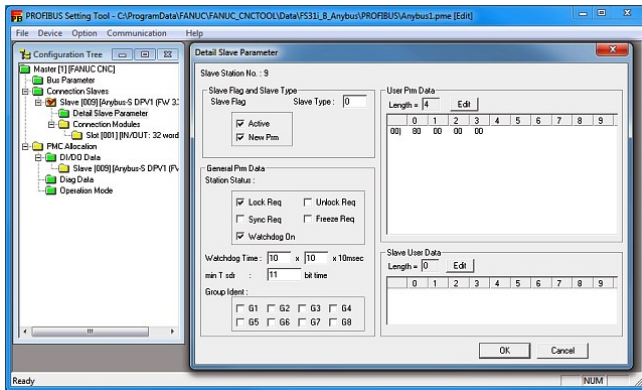

# PROFIBUS Setting Tool

## Features

The PROFIBUS Setting Tool is a Windows® application used to efficiently set PROFIBUS parameters in the CNC from a Personal Computer. The tool simplifies the management of large PROFIBUS network sets.

This software tool can generate PROFIBUS parameters for the CNC using the definition-data file of a slave devices (GSD files supplied by the device vendor). The generated parameters are transferred to the CNC via Ethernet.

## Benefits

- Simplified management of PROFIBUS network settings
- Increase of the efficiency in managing multiple machine settings and large networking projects

### Notice

Certain functions may require additional hardware, different CPU type or additional memory capacity or may cause compatibility issue with other functions. In case of doubt, contact your FANUC sales representative for additional information and support.

The information given in the FANUC manuals or original manufacturer documentation shall prevail. Technical data is subject to change without prior notice. No part of this document may be reproduced in any form. All rights reserved. © FANUC 2017

# 637 Software

## FANUC Connect

### Features

FANUC Connect is a Windows® application software that makes it easy to access and backup various kinds of CNC data from FANUC CNCs through an Ethernet network. FANUC Connect has the functionality of an FTP server, it can be accessed from any software that has an FTP client function. The communication between the FANUC Connect server and the CNC is done via FOCAS/Ethernet. With the automatic backup function, it is possible to backup CNC data automatically according to a specified schedule.

### Benefits

- Simplify and automate the backup of CNC data
- Clients can connect to a CNC without the need of a FOCAS library

### Ordering Information

Specification	Description
A08B-9510-J525	FANUC Connect
A08B-9510-J526	FANUC Connect (Update)

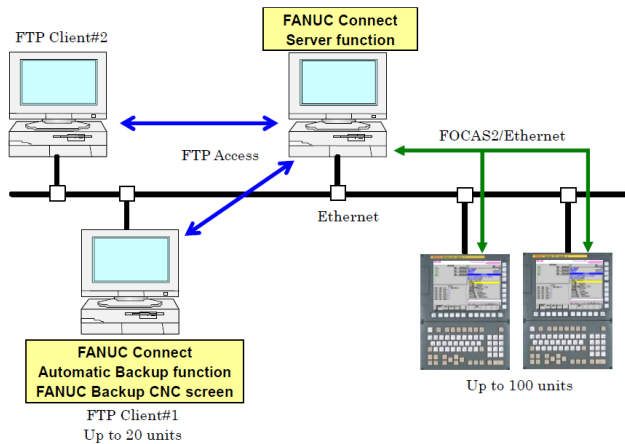

#### Notice

Certain functions may require additional hardware, different CPU type or additional memory capacity or may cause compatibility issue with other functions. In case of doubt, contact your FANUC sales representative for additional information and support.

The information given in the FANUC manuals or original manufacturer documentation shall prevail. Technical data is subject to change without prior notice. No part of this document may be reproduced in any form. All rights reserved. © FANUC 2017

# 638

## Software

# FANUC Customize Assist

## Features

The FANUC Customize Assist tool simplifies the management of software development for a given machine or project. It provides a launcher for the different customization tools provided by FANUC and also a management capabilities for the different files and programming resources.

## Benefits

- Simplification of the management of complex projects
- All tools required are easily accessible from a launcher
- Ease of the files, data and resources management

## Ordering Information

Specification	Description
A08B-9010-J550#ZZ11	FANUC Customize Assist - CNC Series 30i/31i/32i-A

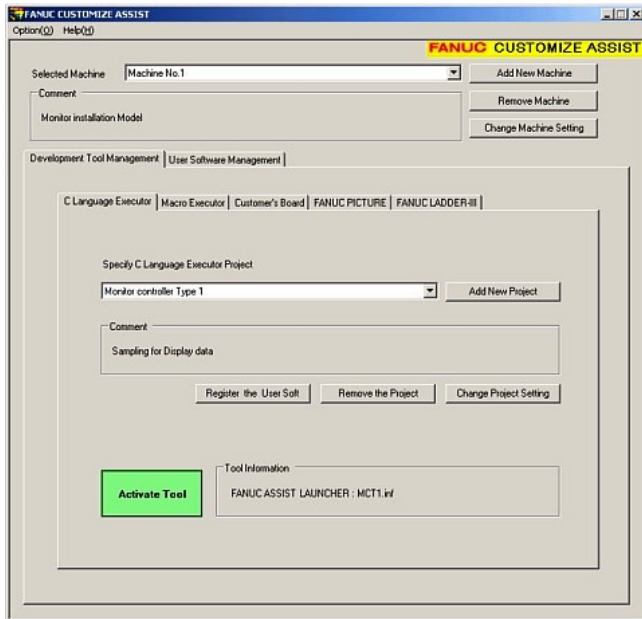

### Notice

Certain functions may require additional hardware, different CPU type or additional memory capacity or may cause compatibility issue with other functions. In case of doubt, contact your FANUC sales representative for additional information and support.

The information given in the FANUC manuals or original manufacturer documentation shall prevail. Technical data is subject to change without prior notice. No part of this document may be reproduced in any form. All rights reserved. © FANUC 2017

# 639 Software

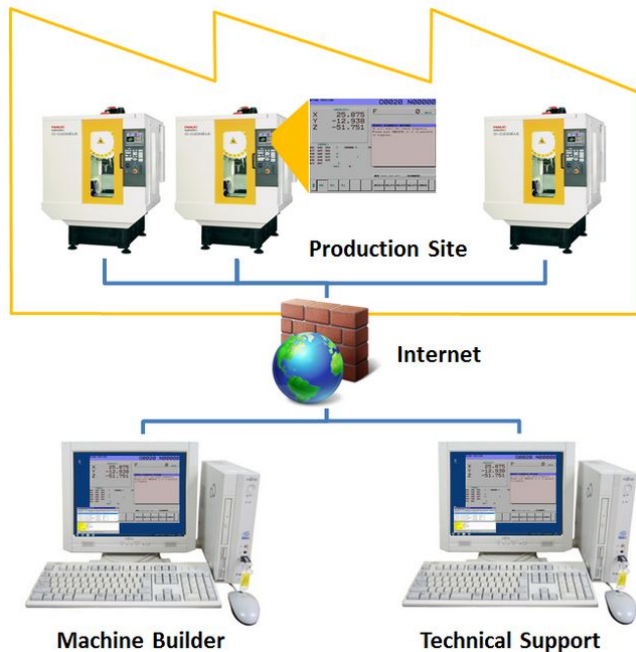

## Machine Remote Diagnosis Package

### Features

The Machine Remote Diagnosis Package application is a tool designed for the machine tool builder to provide remote support of machines easily. This software is designed to use Internet technology to investigate the internal states of remote CNCs and PMCs.

### Key functions

- Communication with a CNC machine tool of an end user over the Internet (or a LAN) to investigate the internal state of the CNC
- Elimination of the need to travel to the machine installation site to check problems; increasing service efficiency
- Server functions to enable quick reception and processing
- Enhanced CNC/PMC operation functions to diagnose problems remotely (sequence program, NC program, and NC parameter corrections can be made for recovery)

The screenshot shows the FANUC RemoteDiagnosticClient - PMC software interface. The window title is "FANUC RemoteDiagnosticClient - PMC". The interface includes a menu bar with "File...", "View", "Option", and "Help". Below the menu bar is a table with the following columns: "Date/time", "Machine ID", "Customer name", "Status", "Receipt n...", and "Comment". The table contains several rows of data, with the second row highlighted in blue. Below the table is a form for customer information with fields for "Machine ID", "Machine name", "Customer", "Phone", "Person in charge", and "Note". At the bottom of the window are three buttons: "Customer information", "Diagnostic history", and "Diagnose".

Date/time	Machine ID	Customer name	Status	Receipt n...	Comment
28/May/2001 7:59:23 PM	200106LS1234	A Industry	Request	26	
28/May/2001 7:45:47 PM	200106LS1234	A Industry	End	25	
28/May/2001 6:32:08 PM	200106LS1234	A Industry	Aborted	24	
17/Apr/2001 2:10:38 PM	MT4444	B Machinery	Aborted	23	
17/Apr/2001 2:09:40 PM	200106LS1234	A Industry	Aborted	22	
17/Apr/2001 9:49:34 AM	200106LS1234	A Industry	End	21	Ord...
17/Apr/2001 9:49:05 AM	MT1234	B Machinery	Aborted	20	

Machine ID	200106LS1234
Machine name	FS16iTB
Customer	A Industry
Phone	0555-84-yyyy
Person in charge	Suzuki
Note	

Customer information      Diagnostic history      Diagnose

### Notice

Certain functions may require additional hardware, different CPU type or additional memory capacity or may cause compatibility issue with other functions. In case of doubt, contact your FANUC sales representative for additional information and support.

The information given in the FANUC manuals or original manufacturer documentation shall prevail. Technical data is subject to change without prior notice. No part of this document may be reproduced in any form. All rights reserved. © FANUC 2017



# 640

## Benefits

- Direct connection between the machine and machine builder through remote operation
- Improvement of the efficiency of the machine service
- Decrease of the ownership costs

## Ordering Information

Specification	Description
A02B-0207-J854	CNC Screen Display Function for Machine Remote Diagnosis Package (Fast Ethernet Required)
A08B-9210-J515	Machine Remote Diagnosis Package (CD-ROM)
A08B-9210-J516	Machine Remote Diagnosis Package (Update for A08B-9210-J515) - Requires a Valid Serial Number Contained in Machine Remote Diagnosis Package (A08B-9210-J515)

### Notice

Certain functions may require additional hardware, different CPU type or additional memory capacity or may cause compatibility issue with other functions. In case of doubt, contact your FANUC sales representative for additional information and support.

The information given in the FANUC manuals or original manufacturer documentation shall prevail. Technical data is subject to change without prior notice. No part of this document may be reproduced in any form. All rights reserved. © FANUC 2017

# 641 Software

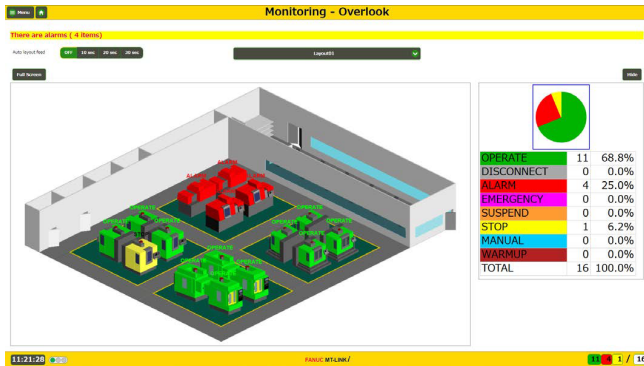

## Notice

Certain functions may require additional hardware, different CPU type or additional memory capacity or may cause compatibility issue with other functions. In case of doubt, contact your FANUC sales representative for additional information and support.

The information given in the FANUC manuals or original manufacturer documentation shall prevail. Technical data is subject to change without prior notice. No part of this document may be reproduced in any form. All rights reserved. © FANUC 2017

# MT-LINKi - CNC Data Collection Software for PC

## Features

MT-LINKi is a suite of operation management software running on personal computers. The suite enables you to monitor multiple equipment units such as CNCs, Robots and PLCs, and to collect and visualize their operational data and production results easily, supporting you to manage your factory efficiently.

MT-LINKi enables you to monitor the state of the whole factory in real-time. Recognize abnormal states of the equipment quickly, allowing you to start countermeasures immediately.

MT-LINKi allows you to review the operational results on machine level and machine group level. You can review the production results and compare them against the production plan. This enables you to optimize the factory's resource planning.

With MT-LINKi, it is possible to view various diagnostic data such as alarm history, program history, signal history and macro value history. This enables you to identify bottlenecks and optimize the production process.

## Benefits

- Reduce downtime and increase productivity.

## Ordering Information

Specification	Description
A08B-9510-J505#ZZ12	FANUC MT-LINK i (50 Machines) - Requires Ethernet in CNC
A08B-9510-J506#ZZ12	FANUC MT-LINK i (100 Machines) - Requires Ethernet in CNC
A08B-9510-J507#ZZ12	FANUC MT-LINK i (Update) - Requires Ethernet in CNC

# 642 Software

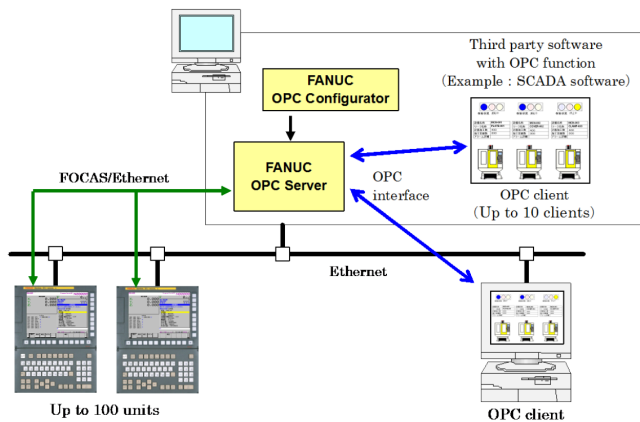

## OPC Server

### Features

OPC is a communication standard for industrial automation. The FANUC OPC Server is a Windows® application software for PCs that converts the communication protocol between OPC and FOCAS. Devices with an OPC client functionality can communicate with FANUC CNCs via this software.

### Benefits

- Connect to a third party application software that has OPC client functionality easily

### Ordering Information

Specification	Description
A08B-9510-J521	FANUC OPC Server - CNC Series 30i/31i/32i-A/B, 35i-B, Power Motion i-A, 0i-D/F
A08B-9510-J522	FANUC OPC Server [Update] - CNC Series 30i/31i/32i-A/B, 35i-B, Power Motion i-A, 0i-B/C/D/F, 16i/18i/21i-A/B, Power Mate i-D/H

#### Notice

Certain functions may require additional hardware, different CPU type or additional memory capacity or may cause compatibility issue with other functions. In case of doubt, contact your FANUC sales representative for additional information and support.

The information given in the FANUC manuals or original manufacturer documentation shall prevail. Technical data is subject to change without prior notice. No part of this document may be reproduced in any form. All rights reserved. © FANUC 2017

# 643

## Software

# Parameter Conversion Support Tool

---

## Features

The Parameter Conversion Tool provides the possibility to convert parameter files created for legacy systems to actual / new CNC systems automatically.

The tool converts for instance parameter files of the Series 16i CNC to the Series 30i CNC, or from Series 0i-MODEL C to Series 0i-MODEL D.

## Benefits

- Simplifies the migration of machines from legacy CNC systems to current CNC systems

## Ordering Information

Specification	Description
A08B-9010-J709#ZZ11	Parameter Conversion Assist Tool for FS 0i-D / 0i-Mate-D - PC-Software for Conversion of FS 0i-C / 0i-Mate-C Parameters to FS 0i-D / 0i-Mate-D Parameters, Specify for each PC

### Notice

Certain functions may require additional hardware, different CPU type or additional memory capacity or may cause compatibility issue with other functions. In case of doubt, contact your FANUC sales representative for additional information and support.

The information given in the FANUC manuals or original manufacturer documentation shall prevail. Technical data is subject to change without prior notice. No part of this document may be reproduced in any form. All rights reserved. © FANUC 2017

# 644 Software

## PC Tool for Memory Card Program Operation/ Editing

### Features

The "Memory Card Program Operation/Editing" function of Series 30i/31i/32i Model A requires a memory card program file on a FAT formatted memory card. This PC tool is used to prepare the memory card program file for this function. The maximum size of the memory card program file is 2048 Mbytes (2 Gbytes).

### Key functions

- Browsing the folders of the memory card program file
- Adding a program to the memory card program file
- Extracting a program in the memory card program file as a text file
- Renaming a program in the memory card program file
- Deleting a program in the memory card program file
- Creating a new folder into the memory card program file
- Renaming a folder in the memory card program file
- Deleting a folder in the memory card program file
- Display of free space on the memory card program file
- Sorting list view of the memory card program file

### Benefits

- Simplified management of parts programs

### Ordering Information

Specification	Description
A08B-9010-J700#ZZ11	PC Tool for Memory Card Program Editing / Operation

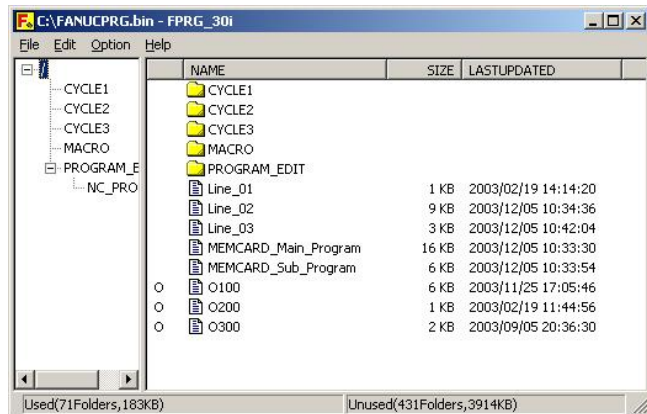

#### Notice

Certain functions may require additional hardware, different CPU type or additional memory capacity or may cause compatibility issue with other functions. In case of doubt, contact your FANUC sales representative for additional information and support.

The information given in the FANUC manuals or original manufacturer documentation shall prevail. Technical data is subject to change without prior notice. No part of this document may be reproduced in any form. All rights reserved. © FANUC 2017

# 645 Software

## Program Transfer Tool

### Features

The Program Transfer Tool is a Windows® application to manage part programs, tool offsets, custom Macro value, workpiece origin offset and tool management data. The data can easily transferred by Ethernet between the CNC memory or data server and a PC. The software allows the operator to delete and rename files/folders or create folders in the CNC or the PC.

### Benefits

- Efficient administration
- Easy and faster managing of programs
- Store and organize backups of CNC data

### Ordering Information

Specification	Description
A08B-9510-J515	Program Transfer Tool (via Ethernet)

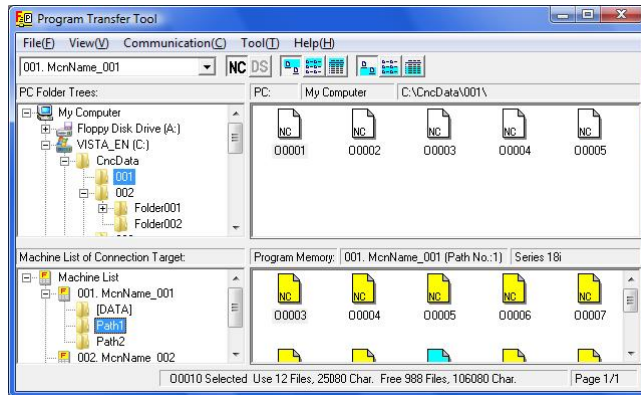

### Notice

Certain functions may require additional hardware, different CPU type or additional memory capacity or may cause compatibility issue with other functions. In case of doubt, contact your FANUC sales representative for additional information and support.

The information given in the FANUC manuals or original manufacturer documentation shall prevail. Technical data is subject to change without prior notice. No part of this document may be reproduced in any form. All rights reserved. © FANUC 2017

# 646 Software

## SERVO Viewer

### Features

SERVO Viewer is a Windows® application software that enables to measure and display various kinds of data from a machine tool with a FANUC CNC. It is possible to acquire and view servo/spindle data such as position, speed and torque, PMC signals, or CNC status information such as program number, sequence number or M/S/T codes.

### Benefits

- Analyze the axis movement and CNC operation timing
- Optimize the CNC program to reduce cycle times
- Monitor the machine's condition by periodical measurements

### Ordering Information

Specification	Description
A08B-9010-J940	Servo Viewer
A08B-9010-J949	Servo Viewer (Update)

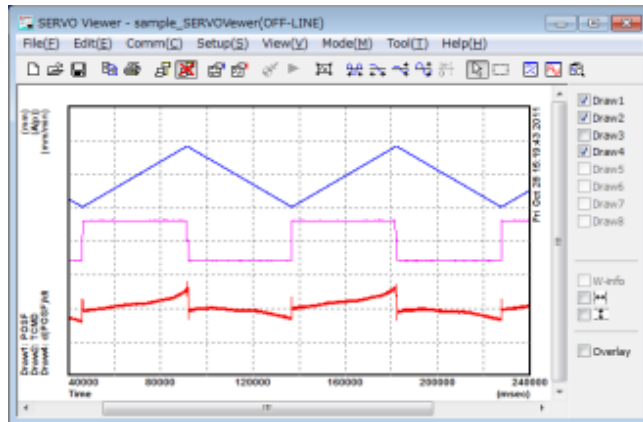

### Notice

Certain functions may require additional hardware, different CPU type or additional memory capacity or may cause compatibility issue with other functions. In case of doubt, contact your FANUC sales representative for additional information and support.

The information given in the FANUC manuals or original manufacturer documentation shall prevail. Technical data is subject to change without prior notice. No part of this document may be reproduced in any form. All rights reserved. © FANUC 2017

# 647 Software



## iHMI Application SDK for Panel iH

### Features

The iHMI Application SDK for Panel iH is a software development kit for the development of iHMI applications on Windows Embedded Compact 7. The necessary documents and libraries for the development of iHMI applications with Visual Studio 8 are included.

### Benefits

- Personalize iHMI on Panel iH with customer-specific applications easily

### Ordering Information

Specification	Description
A08B-9110-J713#ZZ11	iHMI Application SDK for PANEL iH

#### Notice

Certain functions may require additional hardware, different CPU type or additional memory capacity or may cause compatibility issue with other functions. In case of doubt, contact your FANUC sales representative for additional information and support.

The information given in the FANUC manuals or original manufacturer documentation shall prevail. Technical data is subject to change without prior notice. No part of this document may be reproduced in any form. All rights reserved. © FANUC 2017



# 648

## Software

# Disk for Cycle Time Estimate Function

## Features

Cycle Time Estimate is a function that can quickly estimate the execution cycle time of an NC program. It delivers estimations for cutting and rapid traverse times, time spent on the execution of auxiliary codes (e. g. M codes), as well as cutting and rapid traverse travel distances.

The accuracy of the estimation is higher than estimations made with 3rd party software. All estimations are calculated in consideration of the real machine's acceleration and deceleration. It is possible to estimate the machining time of complex programs, for example programs for 5-axis machining.

With the Cycle Time Estimate Library contained in this disk, it is possible to create custom applications that incorporate the Cycle Time Estimate function. In order to use the library, the "Cycle Time Estimate Library function" option has to be effective in the CNC.

## Benefits

- Decrease processing time by optimizing programs
- Improve the utilization of machines by enhanced and reliable machine schedule planning

## Ordering Information

Specification	Description
A08B-9010-J758#ZZ12	Disk for Cycle Time Estimate Function (for CNC), DVD

### Notice

Certain functions may require additional hardware, different CPU type or additional memory capacity or may cause compatibility issue with other functions. In case of doubt, contact your FANUC sales representative for additional information and support.

The information given in the FANUC manuals or original manufacturer documentation shall prevail. Technical data is subject to change without prior notice. No part of this document may be reproduced in any form. All rights reserved. © FANUC 2017

# 649 Software

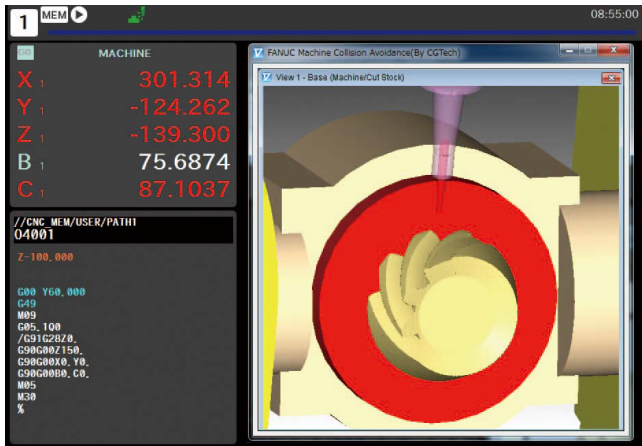

## Notice

Certain functions may require additional hardware, different CPU type or additional memory capacity or may cause compatibility issue with other functions. In case of doubt, contact your FANUC sales representative for additional information and support.

The information given in the FANUC manuals or original manufacturer documentation shall prevail. Technical data is subject to change without prior notice. No part of this document may be reproduced in any form. All rights reserved. © FANUC 2017

# Machine Collision Avoidance for Panel iH Pro

## Features

The Machine Collision Avoidance Function detects potential collisions between all machine tool components such as tables, spindles, work pieces, tool holders, tools, fixtures or other parts of the machine structure beforehand. This is done by performing a simulation based on a 3D machine model and the machine's preview positions. If a potential collision is detected, the machine is stopped safely before the collision occurs, and the tool and jig involved are indicated in the machine model on the display. This function is particularly recommended for 5-axis machines or complex machines, it is effective in manual and automatic operation.

The 3D machine model can be created using the machine's construction data which may be represented in various CAD model formats such as STL and DXF. Blanks and jigs can also be created using CAD models, or standardized shapes such as blocks, cones, cylinders etc. can be used to create them. Tools can be managed by VERICUT and the tool manager of the Machine Collision Avoidance function.

Panel iH Pro and "3D Interference Check by PC function" are necessary to use this function.

## Benefits

- Reduce time spent for proving-out new programs on the machine
- Eliminate the cost of damaged tooling, fixtures and work pieces
- Protect machine and work piece against operating errors during manual operation
- Reduce down time and increase productivity
- Save time by creating the machine model using the machine's construction data

## Ordering Information

Specification	Description
A02B-0207-J921	Machine Collision Avoidance Function for PANEL i with Core i CPU (Display Unit for iHMI)

# Index

## 2

2nd Auxilliary Function.....	325
2nd Feedrate Override.....	220
2nd Geometry Tool Offset.....	375

## 3

3-Dimensional Circular Interpolation.....	179
3-Dimensional Coordinate System Conversion.....	272
3-Dimensional Cutter Compensation.....	391
3-Dimensional Error Compensation.....	413
3-Dimensional Machine Position Compensation.....	416
3-Dimensional Manual Feed.....	134
3-Dimensional Rotary Error Compensation.....	417
3-Dimensional Tool Compensation.....	372
3D Error Compensation Setting Tool.....	631
3D Interference Check with PC Function.....	094
3rd/4th Reference Position Return.....	175

## 4

4th/5th Axis Offset.....	369
--------------------------	-----

## 5

5-Axis Machining Condition Setting Function.....	529
--	-----

## A

AI Contour Control I.....	229
AI Contour Control II.....	230
Acceptance Test Assist Tool.....	607
Accuracy Compensation Functions.....	402
Active Block Cancel.....	146
Actual Spindle Speed Output.....	331
Addition of Custom Macro Common Variables.....	261
Addition of Custom Macro Common Variables 1000.....	262

Addition of Cutting Condition Data.....	451
Addition of Loader Control Path.....	041
Addition of Workpiece Coordinate System 300 Pairs.....	251
Addition of Workpiece Coordinate System 48 Pairs.....	250
Advanced Preview Control.....	228
Arbitrary Angular Axis Control.....	053
Arbitrary Command Multiply.....	068
Arbitrary Position Reference Setting for Cs Axis.....	340
Arbitrary Speed Threading.....	348
Attitude Control.....	463
Automatic Alteration of Tool Position Compensation.....	397
Automatic Corner Override.....	269
Automatic Data Backup.....	546
Automatic Exact Stop Check.....	470
Automatic Gap Control Axis Retract & Approaching Function.....	457
Automatic Phase Synchronization for Flexible Synchronization Control.....	425
Automatic Tool Length Measurement.....	383
Automatic Tool Nose Radius Compensation.....	371
Auxiliary / Spindle Speed Functions.....	324
Auxiliary Function Output During Program Restart.....	120
Auxiliary Function Output in Moving Axis.....	326
Axis Control by PMC.....	036
Axis Immediate Stop Function.....	105
Axis Synchronous Control.....	049

## B

Background Editing.....	484
Balanced Cutting.....	180
Basic Operation Package 2.....	608
Basic Option.....	566
Bell-Shaped Acc./Dec. After Cutting Feed Interpolation.....	219
Bevel Cutting Compensation Function.....	466

Bi-Directional Pitch Error Compensation.....	405
Built-In 3D Interference Check.....	092
Built-In 3D Interference Check Setting Tool.....	632

## C

C Language Executor Additional SRAM.....	283
C-Axis Control.....	432
C-Language Library for C-Language Executor.....	609
CC-Link Remote Device.....	588
CNC.....	019
CNC Application Development Kit.....	606
CNC Parameter Setting Tool.....	634
CNC Screen Display Function (SDF).....	610
CNC Screen Display for 19" LCD.....	523
CNC Screen Dual Display Function.....	522
CNC Screen Web Server Function.....	525
CNC Setting Tool.....	633
Canned Cycles for Drilling.....	266
Canned Cycles for Grinding.....	294
Chamfering / Corner Rounding.....	257
Changing Active Offset Value with Manual Move.....	389
Chopping.....	060
Chopping Function by Flexible Synchronization Control.....	061
Chopping Setting Screen.....	062
Chuck and Tail Stock Barrier.....	089
Circular Thread Cutting.....	169
Circular Thread Cutting B.....	170
Clamp Zone Avoidance Function.....	437
Communication.....	570
Conical/Spiral Interpolation.....	162
Constant Surface Speed Control.....	330
Continuous Dressing.....	184
Continuous High-Speed Skip.....	182
Control Function for Link Type Press.....	113
Controllable Axes Expansion.....	034

Controlled Axes Detach.....	058
Controlled Axis.....	021
Coordinate System Rotation.....	271
Corner Control by Feedrate.....	474
Cross Rail Axis Control.....	107
Cs Contouring Control.....	039
Custom Macro.....	259
Custom Software Size.....	285
Customized Data Expansion.....	378
Cutting / Rapid Switching Function for Path Table Operation.....	207
Cutting Condition Setting Function.....	450
Cutting Point Command.....	364
Cutting Point Interpolation for Cylindrical Interpolation.....	373
Cutting Restart.....	459
Cycle Table Operation Function for Path Table Operation.....	201
Cycle Time Estimate Function for NCGuide.....	623
Cycle Time Estimate Library Function.....	492
Cycle Time Estimate for iHMI.....	491
Cylindrical Interpolation.....	155
Cylindrical Interpolation by Plane Distance Command.....	156

## D

Data Input/Output.....	534
Data Server Explorer Connection.....	538
Delay Time Setting Function of Auxiliary Function Output for PTO.....	202
Designation of Control Paths.....	032
Designation of Controlled Axes.....	023
Designation of Machine Control Type.....	022
Designation of Machine Groups.....	031
Designation of Servo Axes for Spindle Use.....	349
Designation of Spindle Axes.....	037
DeviceNet Adapter (Slave).....	581
DeviceNet Scanner (Master).....	579
Direct Drawing Dimension Programming.....	253
Direct Input of Offset Value Measured B.....	386

Direct Input of Offset Value Measured B for 2-Spindle Lathe.....	393
Direction Change Movement in Auxiliary Function Output Block Function.....	143
Direction-Dependent Type of High-Speed Position Switch.....	101
Disk for Cycle Time Estimate Function.....	648
Dual Check Safety (DCS).....	560
Dual Control Axes Switching.....	059
Dual Position Feedback.....	078
Dynamic Graphic Display Function.....	514
Dynamic Switching of Diameter/Radius Specification.....	245

## E

Edge Machine Function.....	452
Editing Operation.....	477
Electronic Cam Function.....	116
Electronic Cam Support Tool.....	611
Electronic Gear Box (EGB).....	419
Electronic Gear Box (EGB) - 2 pairs.....	421
Electronic Gear Box (EGB) Automatic Phase Synchronization.....	422
Embedded Ethernet.....	571
Embedded Macro.....	292
Energy Saving Level Selection Function.....	526
Enhanced Buffer.....	462
Enlarged CNC Screen Display for 19" LCD.....	524
EtherNet/IP Adapter.....	594
EtherNet/IP Adapter Safety Function.....	596
EtherNet/IP Scanner.....	592
Ethernet Display Function.....	519
Ethernet Display Sharing Function.....	520
Expansion of Axis Command in Tool Center Point Control.....	367
Exponential Interpolation.....	153
Extended Bi-Directional Pitch Error Compensation.....	406
Extended Conversational Macro Function.....	280
Extended P-Code Variables Size.....	300
Extended Spindle Orientation.....	350
Extended Spindle Output Switching Function.....	351

External Data Input.....	542
External Deceleration.....	225
External I/O Device Control.....	544
External Machine Zero Point Shift.....	540
External Message.....	541
External Tool Offset.....	539
External Touch Panel Interface.....	516

## F

FANUC Auto HMI-NC.....	502
FANUC Auto HMI-NC disk.....	626
FANUC Connect.....	637
FANUC Customize Assist.....	638
FANUC Ladder-III.....	627
FANUC PICTURE.....	612
FANUC PICTURE Executor.....	287
FANUC PICTURE Function.....	288
FANUC PICTURE Function for Power Motion i.....	291
FANUC PICTURE Function for Series 35i.....	290
FANUC SERVO GUIDE.....	629
FL-net.....	584
FL-net Safety.....	586
FL-net Setting Tool.....	635
FOCAS2 Library.....	613
Fast Data Server.....	537
Fast Ethernet.....	573
Feed Functions.....	216
Feed Stop.....	226
Feedrate Change Function.....	238
Feedrate Control with Acceleration in Circular Interpolation.....	227
Figure Copying.....	276
Fine Torque Sensing.....	097
Flexible Path Axis Assignment.....	048
Flexible Synchronization Control.....	424
Floating Reference Position Return.....	176

Functions.....	020
Functions for Gas Cutting Machine.....	469
<b>G</b>	
G-Code System B/C.....	254
Gap Control.....	476
Gap Control for Laser.....	456
Gas Cutting Machine Functions.....	468
General Purpose Retract.....	195
Gentle Curve Cutting.....	473
Gentle Normal Direction Control.....	183
Graphic Function.....	513
Grinding Functions.....	430
Groove Cutting Function by Continuous Circle Movement.....	298
Guidance Table for Machine Alarm Diagnosis.....	614
<b>H</b>	
HRV3 Control.....	080
HRV4 Control.....	081
Handle Interruption.....	135
Helical Interpolation.....	157
Helical Interpolation B.....	158
High Speed Press Function.....	447
High Speed Serial Bus (HSSB).....	582
High-Precision Learning Control A.....	069
High-Precision Learning Control B.....	070
High-Precision Learning Control C.....	071
High-Precision Oscillation Function.....	063
High-Speed Binary Program Operation.....	211
High-Speed Binary Program Operation Retract Function.....	213
High-Speed Binary Program Operation on 2-Path Control.....	212
High-Speed Cycle Cutting.....	186
High-Speed Cycle Cutting Additional Variables A.....	189
High-Speed Cycle Cutting Additional Variables B.....	190
High-Speed Cycle Cutting Additional Variables C.....	191
High-Speed Cycle Cutting Additional Variables D.....	192

High-Speed Cycle Cutting Additional Variables E.....	193
High-Speed Cycle Machining Operation Information Output Function.....	194
High-Speed Cycle Machining Retract Function.....	187
High-Speed Cycle Machining Skip Function.....	188
High-Speed Feedrate Override.....	240
High-Speed Measuring Position Reach Signal Input.....	384
High-Speed Position Switch.....	100
High-Speed Processing.....	232
High-Speed Program Check.....	147
High-Speed Program Management.....	489
High-Speed Signal Output Function for Path Table Operation.....	204
High-Speed Skip Function.....	174
High-Speed Smooth TCP.....	366
High-Speed and High-Quality Machining Package.....	215
Hob Command by Flexible Synchronization Control.....	428
Hobbing / Electronic Gear Box.....	418
Hypothetical Axes Interpolation.....	161
Hypothetical Linear Axis Interpolation.....	214
<b>I</b>	
In-Acceleration/Deceleration Signal.....	472
In-Position Check Switching Function for Drilling Canned Cycle.....	267
Inch/Metric Conversion.....	082
Inclination Compensation.....	409
Inclined Rotary Axis Control.....	054
Increment System C.....	065
Increment System D.....	066
Increment System E.....	067
Incremental Command for Path Table Operation.....	205
Index Table Indexing.....	181
Infeed Control.....	185
Integrated Operation & Programming Guidance Functions.....	304
Inter-Path Flexible Synchronization Control.....	426
Inter-Unit Synchronization (Power Motion i-A).....	604
Interaction Control.....	464

Interference Check for Each Path.....	090
Interference Check for Rotary Area.....	091
Interpolated Straightness Compensation 3072 Points.....	412
Interpolation Functions.....	151
Interpolation Type Pitch Error Compensation.....	404
Interpolation Type Straightness Compensation.....	411
Interruption Type Custom Macro.....	263
Inverse Time Feed.....	222
Involute Interpolation.....	160

## J

Jerk Control.....	234
-------------------	-----

## K

Key and Program Encryption.....	481
---------------------------------	-----

## L

LADDER Editing Package Execute Files.....	615
Laser Functions.....	448
Laser High-Speed Control Function 2.....	454
Laser Oscillator Communication Control (FSSB Connection).....	455
Lathe / Machining Center G-Code System Switching Function.....	256
Learning Control - Memory Expansion.....	076
Learning Control for Parts Cutting A.....	072
Learning Control for Parts Cutting B.....	073
Learning Helical Interpolation.....	159
Learning Memory Size 10Mbyte.....	077
Linear Inclination Compensation Function.....	415
Linear Scale Interface with Absolute Address Reference Mark.....	102
Linear/Circular Punch Command.....	440
Loader Control Function.....	040
Look-Ahead Blocks Expansion.....	233
Look-Ahead Blocks Expansion of AI Contour Control II.....	231

## M

M-Code Group Check Function.....	341
----------------------------------	-----

M-Code Protect Function.....	297
MACRO Compiler and Library.....	618
MANUAL GUIDE 0i.....	314
MANUAL GUIDE i Advanced Guidance Function.....	312
MANUAL GUIDE i Basic Software.....	305
MANUAL GUIDE i Extended Axis Name Function.....	313
MANUAL GUIDE i Handle Machining Function.....	311
MANUAL GUIDE i Multi-Path Support.....	307
MANUAL GUIDE i Tilted Working Plane (TWP) Machining Function.....	308
MANUAL GUIDE i Windows Call Function.....	310
MDI Reset Key Invalidation.....	150
MT-LINKi - CNC Data Collection Software for PC.....	641
Machine Alarm Diagnosis.....	495
Machine Collision Avoidance for Panel iH Pro.....	649
Machine Configuration Selecting Function.....	528
Machine Operation Menu.....	500
Machine Operation Menu Making Tool.....	616
Machine Remote Diagnosis Package.....	639
Machine Safety Functions.....	559
Machine Setting Switching Function.....	533
Machine State Monitoring Function.....	527
Machining Condition Selecting Function.....	511
Machining Quality Level Adjustment.....	512
Machining Status Monitor Package Disk.....	617
Machining Time Stamp.....	483
Macro Executor.....	278
Macro Executor + C-Language Executor.....	281
Macro for Multi-Axes High-Response Function.....	299
Main Menu Screen.....	530
Main Menu Screen Customization Tool.....	620
Manual 2nd/3rd/4th Reference Position Return.....	126
Manual Handle Feed - Multiple 10 Million.....	133
Manual Handle Feed 1 Unit.....	130
Manual Handle Feed 2/3 Units.....	131
Manual Handle Feed 4/5 Units.....	132

Manual Handle Interface for BETA i Series with I/O-Link.....	137
Manual Handle Retrace.....	141
Manual Handle Retrace for Multi-Path.....	142
Manual Interruption of 3D Coordinate Conversion.....	136
Manual Intervention and Return.....	123
Manual Linear/Circular Interpolation.....	144
Manual Numerical Command.....	138
Maximum Look-Ahead Blocks 400.....	241
Memory Card Program Entry Count Extension.....	485
Middle-Level Task for C-Language Executor.....	284
Milling Standard Package.....	568
Minimum Unit 1% Duty Override.....	453
Mirror Image for Double Turret.....	268
Modbus/TCP Server.....	597
Multi-Axes High-Response Function.....	109
Multi-Axes Synchronous Function (Power Motion i-A).....	108
Multi-Language Display.....	504
Multi-Path Editing Function.....	488
Multi-Path PMC Function.....	551
Multi-Path Program Management Function.....	490
Multi-Piece Machining.....	460
Multi-Piece Machining.....	442
Multi-Piece Machining End Area Command.....	443
Multi-Piece Machining End Area Command.....	461
Multi-Repetitive Cycles.....	264
Multi-Repetitive Cycles II.....	265
Multi-Spindle Control.....	336
Multi-Step Skip Function.....	173
Multiple Tool Control.....	445

## N

NCGuide.....	622
NCGuide Academic Package.....	625
NURBS Interpolation.....	178
Nano Smoothing.....	164

Non-Volatile PMC Data Table Area Expansion (40kB).....	557
Non-Volatile PMC Extra Relay Function.....	556
Normal Direction Control.....	177
Number of Custom Macro Variable Name 1000.....	301
Number of Custom Macro Variable Name 4000.....	302
Number of Registered Programs.....	480
Nutating Rotary Head Tool Length Compensation.....	396

## O

OPC Server.....	642
One Touch Macro Call.....	545
One-Digit F-Code Feed.....	221
Operation.....	117
Operation History Converter Tool.....	621
Optimum Torque Acceleration/Deceleration.....	217
Optimum Torque Acceleration/Deceleration for Rigid Tapping.....	236
Option Packages.....	565
Optional Block Skip.....	244
Optional Chamfering / Corner Rounding.....	258

## P

PC Tool for Memory Card Program Operation/Editing.....	644
PMC Axis Control - Acceleration/Deceleration Specification Feed.....	064
PMC Function Block Function.....	558
PMC Ladder Function.....	549
PMC Symbol, Comment and Message Area Expansion.....	552
PMC System.....	548
PROFIBUS Setting Tool.....	636
PROFIBUS-DP Master.....	575
PROFIBUS-DP Slave.....	577
PROFINET I/O Controller.....	599
PROFINET I/O Device.....	601
PROFINET I/O Device Safety Function.....	603
Parallel Axis Control.....	051
Parameter Conversion Support Tool.....	643
Part Program Storage Size.....	478



Path Table Direct Conversion Function.....	203
Path Table Operation (PTO).....	196
Path Table Operation Execution Data Size 20Mbyte.....	209
Path Table Operation History Function.....	210
Pattern Data Input.....	296
Periodical Secondary Pitch Error Compensation.....	407
Peripheral Axis Control.....	042
Pivot Axis Control.....	055
Plane Conversion Function.....	246
Playback.....	482
Polar Coordinate Command.....	247
Polar Coordinate Interpolation.....	154
Pole Position Detection Function.....	057
Polygon Machining with Two Spindles.....	172
Polygon Turning.....	171
Polygon Turning Function for Path Table Operation.....	198
Position Control Keep Function.....	115
Position Definition Type Synchronous Function.....	111
Position Feedback Dynamic Switching Function.....	079
Position Switch.....	099
Positioning by Optimum Acceleration.....	218
Positioning in Machine Coordinate System with Feedrate.....	252
Power Mate CNC Manager.....	543
Pressure and Position Control Function.....	112
Program Auto Restart.....	439
Program Auto Restart.....	458
Program Input.....	243
Program Restart.....	119
Program Transfer Tool.....	645
Programmable Mirror Image.....	275
Programmable Rapid Traverse Overlap.....	237
Protection of Data at Eight Levels.....	510
Pulse Superimposed Function.....	149
Punch Press Function for Compound Cutting.....	467
Punch Press Functions.....	431

## Q

Quick Program Restart.....	121
----------------------------	-----

## R

RAM-Axis Control.....	438
RS232C Interface.....	535
RS232C Interface Expansion of Receiving Buffer.....	536
Rate Feed.....	223
Real Time Custom Macro.....	295
Reference Point Setting with Mechanical Stopper.....	127
Reference Point Setting with Mechanical Stopper by Grid Method.....	129
Reference Point Setting with Mechanical Stopper for Feed Axis Synchronization Control.....	128
Reference Position Signal Output.....	139
Retrace.....	140
Retraction for 3-Dimensional Rigid Tapping.....	125
Retraction for Rigid Tapping.....	124
Reverse Motion Function for Restart.....	145
Rigid Tapping.....	338
Rigid Tapping by Manual Handle.....	339
Rigid Tapping with Bell-Shaped Acceleration/Deceleration.....	235
Robot Connection Function.....	590
Rotary Axis Control.....	098
Rotary Table Dynamic Fixture Offset.....	387
Run Hour and Parts Count Display.....	494

## S

SERVO Viewer.....	646
Safety I/O Signal History Function.....	562
Safety Spindle Speed Limit Override.....	563
Safety Zone Area Expansion.....	436
Safety Zone Check.....	435
Scaling.....	270
Selection of Five Optional Languages.....	509
Sequence Number Comparison and Stop.....	118
Servo-On Synchronize Function.....	114

Servo/Spindle Waveform Data Output Function.....	497
Set-Up Guidance Function.....	303
Setting and Display.....	493
Simple Spindle Synchronous Control.....	335
Simultaneously Controlled Axes Expansion.....	035
Single Direction Positioning.....	152
Skip Function for Electronic Gear Box (EGB) Axis.....	420
Skip Function for Flexible Synchronization Control.....	427
Skip Function for Multi-Axes High-Response Function.....	110
Small-Hole Peck Drilling Cycle.....	293
Smart Adaptive Control.....	242
Smooth Interpolation.....	163
Smooth TCP.....	365
Smooth Tolerance Control.....	165
Software.....	605
Software Operator's Panel.....	498
Software Operator's Panel General Purpose Switch.....	499
Spindle Analog Output.....	329
Spindle Axes Expansion.....	352
Spindle Control Switching Function for High-Speed Machining.....	346
Spindle Control with Cs Contour Control.....	345
Spindle Control with Servo Motor.....	343
Spindle Electronic Gear Box (EGB).....	423
Spindle Learning Control.....	074
Spindle Learning Control in High-Precision Learning Control A/B.....	075
Spindle Orientation.....	332
Spindle Output Switching Function.....	333
Spindle Positioning.....	337
Spindle Serial Output.....	328
Spindle Serial/Analog Output.....	353
Spindle Speed Fluctuation Detection.....	342
Spindle Speed Fluctuation Detection for Path Table Operation.....	197
Spindle Switching Function.....	354
Spindle Synchronous Control.....	334
Spindle Synchronous Control for Guide Bush.....	355

Spindle Unit Compensation.....	395
Standard Laser Functions.....	449
Step Sequence Function.....	554
Stored Pitch Error Compensation.....	403
Stored Stroke Check 1 Area Expansion.....	083
Stored Stroke Check 2,3.....	085
Stored Stroke Check Before Move.....	086
Stored Stroke Limit Range Switching Function by Signal.....	088
Straightness Compensation.....	410
Stroke Limit Area Changing Function.....	087
Stroke Limit External Setting.....	084
Sub-Table Call for Path Table Operation.....	206
Superimposed Control.....	044
Superimposed Control A.....	045
Superimposed Control for High-Speed Cycle Machining.....	046
Synchronous and Composite Control.....	043
Synchronous, Composite and Superimposed Control by Program Command.....	047

## T

T- and C-Axes Simultaneous Control.....	434
TURN MATE i Basic Software.....	316
TURN MATE i Expansion of Machining Cycles.....	320
TURN MATE i MDI Key Operation Function.....	318
TURN MATE i NC Program Conversion Function.....	319
Tandem Disturbance Elimination Function.....	056
Tape Format for Series 15 CNC.....	277
Template Program Function.....	486
Temporary Absolute Coordinate Setting.....	104
Test Mode Function for Dual Check Safety Acceptance Test.....	564
Thermal Growth Compensation Along Tool Vector.....	414
Thread Cutting Retract.....	167
Thread Cutting, Synchronous Cutting.....	166
Thread Start Position Compensation for Changing Spindle Speed.....	347
Threading Start Position Shift Function for Path Table Operation.....	199
Tilted Working Plane (TWP).....	273

Time Constant of Acc./Dec. After Interpolation Switching Function by Signal.....	239
Time Override Function for Dwell/Auxiliary Function.....	148
Tool Attachment/Detachment Management Function.....	381
Tool Center Point Control.....	362
Tool Data Setting Function.....	444
Tool Functions / Tool Compensation.....	356
Tool Geometry Size Data.....	400
Tool Geometry Size Data - Additional Tool Type.....	401
Tool Geometry/Wear Compensation.....	374
Tool Length / Work Zero Point Measurement.....	385
Tool Length Compensation in Tool Axis Direction.....	390
Tool Life Management.....	394
Tool Life Management.....	446
Tool Management Expansion.....	379
Tool Management Expansion B.....	382
Tool Management Function for Multi-Edge Tools.....	380
Tool Offset.....	361
Tool Offset B.....	475
Tool Offset Conversion Function.....	399
Tool Offset Function for Path Table Operation.....	200
Tool Offset Memory B.....	359
Tool Offset Memory C.....	360
Tool Offset Pairs.....	357
Tool Offset for Milling and Turning Function.....	398
Tool Pairs for Tool Management Function.....	376
Tool Posture Control.....	363
Tool Radius / Tool Nose Radius Compensation.....	370
Tool Retract and Recover.....	122
Torch Swing for Gas Cutting Machine.....	471
Touch Panel Control.....	515

Twin Display Function with Ethernet.....	521
Twin Table Control.....	050
Two Touch Panels Control for Stand-Alone Type CNC.....	517

## U

U-Axis Control 2 pairs.....	429
Unexpected Disturbance Torque Detection Function.....	095
Unexpected Disturbance Torque Detection for BETA i I/O Link.....	096

## V

Variable Lead Thread Cutting.....	168
Virtual MDI Key.....	518

## W

W-Axis Gap Control.....	465
Waiting Function by Specifying Start Point.....	327
Warning Function Against Modification of Setting.....	532
Wheel Wear Compensation.....	388
Workpiece Coordinate System.....	248
Workpiece Coordinate System Preset.....	249
Workpiece Setting Error Compensation.....	392

## Y

Y-Axis Crack Cancel.....	441
Y-Axis Offset.....	368

## i

iHMI Application SDK for Panel iH.....	647
iHMI Conversational Programming for Complex Lathe.....	323
iHMI Machining Cycle.....	321
iHMI Set-Up Guidance.....	322



**MANUFACTURED EFFICIENCY:  
5 PRODUCT GROUPS -  
ONE COMMON SERVO  
AND CONTROL PLATFORM**



**FA**  
CNCs, Servo Motors  
and Lasers



**ROBOTS**  
Industrial Robots,  
Accessories and Software



**ROBOCUT**  
CNC Wire-Cut Electric  
Discharge Machines



**ROBODRILL**  
Compact CNC Machining  
Centres

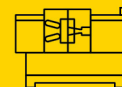

**ROBOSHOT**  
Electric CNC Injection  
Moulding Machines



[WWW.FANUC.EU](http://WWW.FANUC.EU)