

Miniature Centrifugal Pumps

B401...501

Peripheral impellers

B401...501
Immersion Version

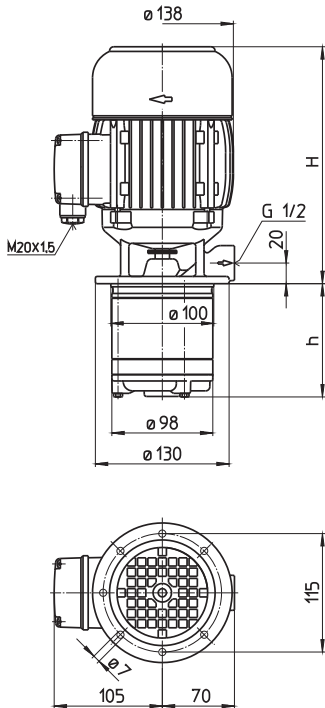

B401...501
Base-mounted Version

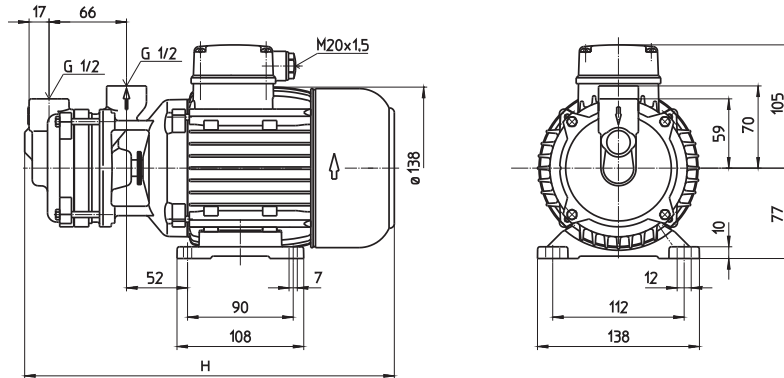

Type	Vol. del. at manom. del. head l/min / m	Dimensions		Weight kg	Power kW	Voltage 3 ~ V	Fre- quen- cy Hz	Current A	Speed 1/min
		H mm	h mm						
B401/110	10/30	230	110	9.5	0.63	220-240	50	2.6	2750
B401-F		297	67	9.8		380-420	50	1.5	2750
B501/110	10/45	271	110	11.5	0.92	220-240	50	3.8	2840
B501-F		341	67	11.8		380-415	50	2.2	2840
					1.06	460	60	2.1	3440



Miniature Centrifugal Pumps

Series B401 ...501 are suitable for pumping **clean fluids** up to 140° C temperature and 5 bar system-pressure.

For open circuits see immersion pumps TS12...24.

The minimum liquid level for immersion pumps of the B-series installed vertically must reach the lower impeller.

Applications

Types of fluid

Industry water up to 140° C at 5 bar system-pressure

Pumping temperature

...+ 140° C

Construction

Pump body	bronze
Cover	bronze
Impeller	brass
Shaft	Cr-steel
Optional:	
Cover	CrNi-steel
Impeller	CrNi-steel
Noise level	
B401...B501	65 dBA

